

**BLUE-MASTER®**  
by *celesa*

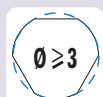

AVELLANADORES

**BROCAS ESCALONADAS DE CANALES RECTOS HSS**
**HSS**

Ref. AV40

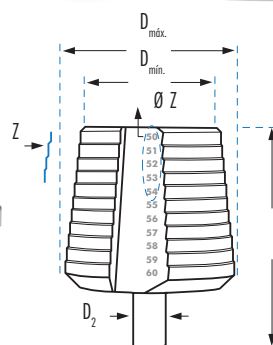
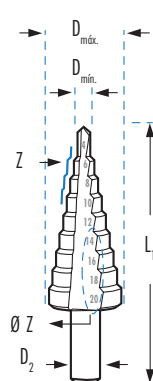
**BM1**
**BM2**
**BM3**
**BM4**
**BM5**

Ref. AV40BM25 / 26 / 27 / 28 / 29

**AV40**

	D min. mm	D max. mm	D2 mm	L1 mm	Z	Ø Z mm menor-mayor	AV40	
							HSS €	TiN €
AV40BM1B	4,0	12,0	6,0	65	5	4-6-8-10-12	40,72	64,25
AV40BM2B	4,0	12,0	6,0	65	9	4-5-6-7-8-9-10-11-12	41,77	64,62
AV40BM3B	4,0	20,0	8,0	69	9	4-6-8-10-12-14-16-18-20	53,55	82,48
AV40BM4B	4,0	30,0	10,0	96	14	4-6-8-10-12-14-16-18-20-22-24-26-28-30	87,84	133,90
AV40BM14	4,0	39,0	10,0	107	13	4-6-9-12-15-18-21-24-27-30-33-36-39	217,94	336,55
AV40BM16B	5,0	28,0	10,0	69	7	5-8-8-11,8-15,3-19-24,5-28	101,09	159,09
AV40BM35B	5,0	35,0	13,0	80	13	5-7-10-12-15-17-20-22-25-27-30-32-35	130,87	190,28
AV40BM11B	6,0	25,0	10,0	65	7	6-9-12-16-20-22,50-25	82,55	111,11
AV40BM10B	6,0	26,7	10,0	75	8	6-9-11,40-14-17,25-19-21,25-26,75	160,73	252,93
AV40BM17B	6,0	30,5	10,0	80	9	6-9-12,5-15,2-18,6-20,4-22,5-28,3-30,5	170,65	268,53
AV40BM12B	6,0	32,0	10,0	75	9	6-9-12-16-20-22,5-25-28,5-32	116,51	140,22
AV40BM18B	6,0	37,0	10,0	100	12	6-9-12,5-15,2-18,6-20,4-22,5-26-28,3-30,5-34-37	189,65	293,96
AV40BM5B	6,0	38,0	10,0	96	12	6-9-13-16-19-21-23-26-29-32-35-38	204,62	271,25
AV40BM13	6,0	40,0	13,0	105	16	6-11-17-23-29-30-31-32-33-34-35-36-37-38-39-40	282,17	319,36
AV40BM15B	6,5	32,5	10,0	79	9	6,50-8,50-10,50-12,50-16,50-20,50-25,50-29-32,50	134,90	189,06
AV40BM20	6,5	40,5	10,0	96	11	6,50-8,50-10,50-12,50-16,50-20,50-25,50-29 32,50-36,50-40,50	211,49	332,81
AV40BM21B	7,0	20,0	10,0	80	12	7-10-11-12-13-14-15-16-17-18-19-20	84,62	133,16
AV40BM22B	10,0	30,0	13,0	83	12	10-20-21-22-23-24-25-26-27-28-29-30	132,46	207,81
AV40BM25B	12,0	20,0	8,0	66	9	12-13-14-15-16-17-18-19-20	78,46	105,01
AV40BM26B	20,0	30,0	10,0	78	11	20-21-22-23-24-25-26-27-28-29-30	114,45	161,23
AV40BM27	30,0	40,0	10,0	78	11	30-31-32-33-34-35-36-37-38-39-40	171,42	220,70
AV40BM28	40,0	50,0	13,0	85	11	40-41-42-43-44-45-46-47-48-49-50	245,06	341,55
AV40BM29	50,0	60,0	13,0	85	11	50-51-52-53-54-55-56-57-58-59-60	308,77	383,55

**PARA PASAR TUBERÍAS ROSCA GAS**

AV40BM6B	6,0	32,0	10,0	75	8	6-9-11,20(1/8)-14,50 (1/4)-18,20 (3/8)-22,30 (1/2)-27,90 (3/4)-32	120,88	165,71
----------	-----	------	------	----	---	---	--------	--------

**PARA REMACHES CIEGOS M3 - M4 - M5 - M6 Y M7**

AV40BM7B	4,8	10,6	6,0	54	5	4,80-6,40-7,20-9,60-10,65	39,39	56,20
----------	-----	------	-----	----	---	---------------------------	-------	-------

**PARA CONDUCCIONES ELÉCTRICAS (ANTIGUA Y NUEVA NORMA)**

AV40PG21B	PG7	PG21	13,0	70	11	6,5-8,5-10,5-12,5(PG7)-15,2(PG9)-18,6(PG11) 20,4(PG13,5)-22,5(PG16)-25,5-18,3(PG21)-30,5	133,11	188,18
AV40PG29B	PG7	PG29	13,0	81	14	6,5-9-11-12,5(PG7)-15,2(PG9)-18,6(PG11)-20,4(PG13,5) 22,5(PG16)-26-28,3(PG21)-30,5-33-35-37(PG29)	171,96	241,23
AV40BM8B	8,5	32,5	10,0	70	12	8,5-10,5-12,5-14,5-16,5-18,5-20,5-23,5-25,5 28-30,5-32,5	100,91	146,22
AV40BM9B	8,5	40,5	12,0	84	16	8,5-10,5-12,5-14,5-16,5-18,5-20,5-23,5-25,5 28-30,5-32,5-34,5-36,5-38,5-40,5	143,69	216,55

BROCAS ESCALONADAS DE CANALES RECTOS HSSCO

**HSSCo** **INOX** Ref. AVC40

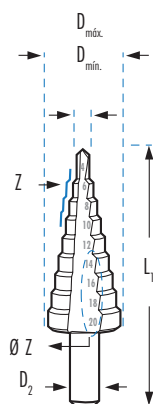

**BM1 BM2 BM3 BM4 BM18**



AVC40

	D mín. mm	D máx. mm	D2 mm	L1 mm	Z	Ø Z mm menor-mayor	HSSCo €	TiN €
AVC40BM1B	4,0	12,0	6,0	65	5	4-6-8-10-12	50,08	76,78
AVC40BM2B	4,0	12,0	6,0	65	9	4-5-6-7-8-9-10-11-12	52,88	92,74
AVC40BM3B	4,0	20,0	8,0	69	9	4-6-8-10-12-14-16-18-20	64,94	105,07
AVC40BM4B	4,0	30,0	10,0	96	14	4-6-8-10-12-14-16-18-20-22-24-26-28-30	100,59	164,70
AVC40BM18B	6,0	37,0	10,0	100	12	6-9-12,5-15,2-18,6-20,4-22,5-26-28,3-30,5-34-37	205,94	309,27

BROCAS ESCALONADAS DE CANALES RECTOS HSS SDS-PLUS

**NEW** **HSS** **SDS Plus** Ref. AV40BMSDS

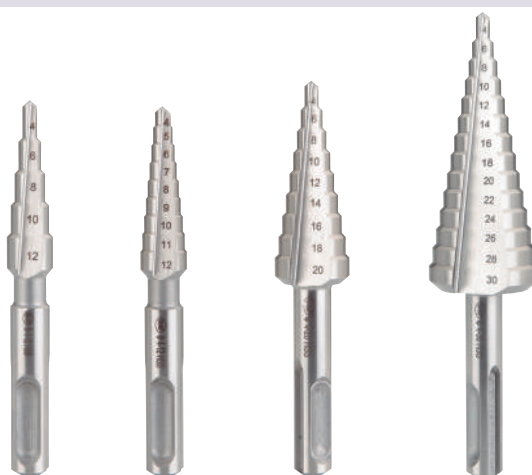
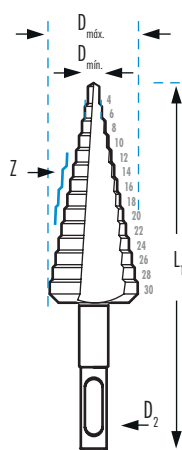

**BMSDS1 BMSDS2 BMSDS3 BMSDS4**



AV40BMSDS

	D mín. mm	D máx. mm	D2 mm	L1 mm	Z	Ø Z mm menor-mayor	HSS €	TiN €
AV40BMSDS1B	4,0	12,0	8,8	95,5	5	4-6-8-10-12	43,16	68,11
AV40BMSDS2B	4,0	12,0	8,8	95,5	9	4-5-6-7-8-9-10-11-12	44,27	68,50
AV40BMSDS3B	4,0	20,0	8,8	104,0	9	4-6-8-10-12-14-16-18-20	56,76	87,43
AV40BMSDS4B	4,0	30,0	8,8	126,0	14	4-6-8-10-12-14-16-18-20-22-24-26-28-30	93,11	141,93

**BROCAS ESCALONADAS DE CANALES HELICOIDALES HSS**
**HSS**

Ref. AV42



BM2

BM3

BM4

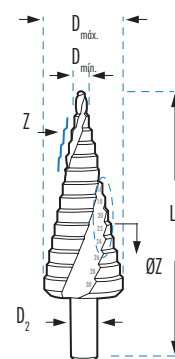

AV42

	D mín. mm	D máx. mm	D2 mm	L1 mm	Z	Ø Z mm menor-mayor	HSS	TiN
							€	€
AV42BM1B	4,0	12,0	6,0	65	5	4-6-8-10-12	45,71	65,46
AV42BM2B	4,0	12,0	6,0	68	9	4-5-6-7-8-9-10-11-12	46,17	68,17
AV42BM3B	4,0	20,0	8,0	69	9	4-6-8-10-12-14-16-18-20	61,59	95,30
AV42BM4B	4,0	30,0	10,0	96	14	4-6-8-10-12-14-16-18-20-22-24-26-28-30	101,51	151,72
AV42BM5B	6,0	38,0	10,0	96	12	6-9-13-16-19-21-23-26-29-32-35-38	218,71	285,25
AV42BM11B	6,0	25,0	10,0	65	7	6-9-12-16-20-22,50-25	85,98	119,36
AV42BM12B	6,0	32,0	10,0	75	9	6-9-12-16-20-22,5-25-28,5-32	124,60	159,36
AV42BM13	6,0	40,0	13,0	105	16	6-11-17-23-29-30-31-32-33-34-35-36-37-38-39-40	288,78	326,36
AV42BM8B	8,5	32,5	10,0	70	12	8,5-10,5-12,5-14,5-16,5-18,5-20,5-23,5 25,5-28-30,5-32,5	113,18	155,25
AV42BM9B	8,5	40,5	12,0	84	16	8,5-10,5-12,5-14,5-16,5-18,5-20,5-23,5 25,5-28-30,5-32,5-34,5-36,5-38,5-40,5	177,98	231,55

**BROCAS MEGA ESCALONADAS DE CANALES HELICOIDALES HSS**
**NEW**
**HSS**

Ref. AV42BM7



AV42BM702B

AV42BM703B

AV42BM704B

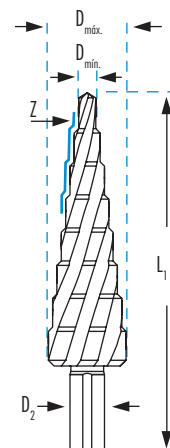

AV42

	D mín. mm	D máx. mm	D2 mm	L1 mm	Z	Ø Z mm menor-mayor	HSS	TiAIN
							€	€
AV42BM702B	6,0	12,0	6,0	105	7	6-7-8-9-10-11-12	45,95	51,05
AV42BM703B	6,0	20,0	10,0	120	8	6-8-10-12-14-16-18-20	72,11	80,12
AV42BM704B	6,0	27,0	12,0	125	8	6-9-12-15-18-21-24-27	94,88	105,42

BROCA MICROESCALONADAS HSS



STEP CUT

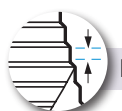
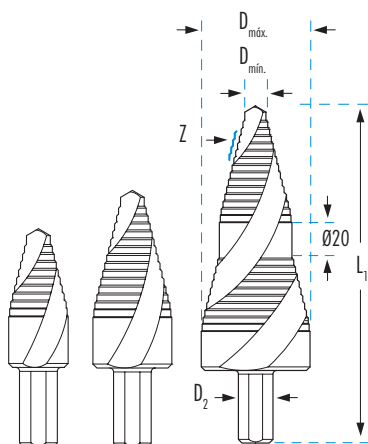

ESCALÓN 2 mm



AV40BM37

AV40BM38

AV40BM36

	D mín. mm	D máx. mm	D <sub>2</sub> mm	L1 mm	Z	Ø Z mm menor-mayor	AV40BM	
							HSS €	TiN €
AV40BM37B	6,0	15,0	9,5	55	11	6-7-8-9-10-11-12-13-14-14,5-15	27,75	36,42
AV40BM38B	6,0	20,0	9,5	65	16	6-7-8-9-10-11-12-13-14-15-16-17-18-19-19,5-20	41,49	57,02
AV40BM36B	6,0	30,0	9,5	93	27	6-7-8-9-10-11-12-13-14-15-16-17-18-19-19,5-20-21-22-23-24-25-26-27-28-29-29,5-30	102,31	147,33

MANGO HEXAGONAL 1/4"

	D mín. mm	D máx. mm		L1 mm	Z	Ø Z mm menor-mayor	AV41	
							HSS €	TiN €
AV41BM2B	4,0	12,0	1/4"	72	9	4-5-6-7-8-9-10-11-12	46,17	68,17
AV41BM3B	4,0	20,0	1/4"	81	9	4-6-8-10-12-14-16-18-20	61,59	95,30
AV41BM4B	4,0	30,0	1/4"	105	14	4-6-8-10-12-14-16-18-20-22-24-26-28-30	101,51	151,72



Ref. AV41BM2B

SERIE CORTA Máximo 2 mm de espesor

	D mín. mm	D máx. mm	D <sub>2</sub> mm	L1 mm	Z	Ø Z mm menor-mayor	AV41C	
							HSS €	TiN €
AV41CBM2B	4,0	12,0	6,0	48	9	4-5-6-7-8-9-10-11-12	50,94	68,37
AV41CBM3B	4,0	20,0	8,0	58	9	4-6-8-10-12-14-16-18-20	63,24	88,36
AV41CBM4B	4,0	30,0	10,0	72	14	4-6-8-10-12-14-16-18-20-22-24-26-28-30	103,10	158,74



Ref. AV41CBM3B



**BROCAS ESCALONADAS HSS CARACTERÍSTICAS ESPECIALES**
**HSS**
**ATORNILLAMIENTOS MÉTRICOS DE CABLE**

	DIN	D mín. mm	D máx. mm	D2 mm	L1 mm	Z	Ø Z mm menor-mayor	AV45	
								HSS €	TiN €
AV45BM0B	60423	5,3	30,5	10,0	79	9	5,3-7-9-10,5-14,5-18,5-23,5-27-30,5	180,94	233,33
AV45BM2B	60423	5,3	38,5	10,0	96	11	5,3-7-9-10,5-14,5-18,5-23,5-27-30,5-34,5-38,5	217,59	274,91



Ref. AV45BM2B

**ESCALONADA RECTA CON 3 CORTES**

	D mín. mm	D máx. mm	D2 mm	L1 mm	Z	Ø Z mm menor-mayor	AV43	
							HSS €	TiN €
AV43BM1B	4,0	12,0	6,0	65	9	4-5-6-7-8-9-10-11-12	47,58	75,36
AV43BM2B	4,0	20,0	8,0	75	9	4-6-8-10-12-14-16-18-20	65,23	101,07
AV43BM3B	4,0	30,0	10,0	100	14	4-6-8-10-12-14-16-18-20-22-24-26-28-30	100,54	164,44

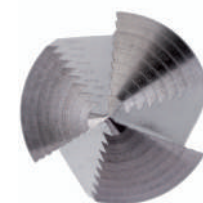

Ref. AV43BM3B

**BROCA ESCALONADA CON BROCA GUIA INTERCAMBIABLE**

	D mín. mm	D máx. mm	D2 mm	L1 mm	Z	Ø Z mm menor-mayor	AV4	
							HSS €	
AV4BM3040	30,0	40,0	13,0	76	11	30-31-32-33-34-35-36-37-38-39-40	165,83	
AV4BM4050	40,0	50,0	13,0	76	11	40-41-42-43-44-45-46-47-48-49-50	239,52	
AV4BM5060	50,0	60,0	13,0	76	11	50-51-52-53-54-55-56-57-58-59-60	304,05	



Ref. AV4BM3040

**BROCA GUÍA**

	DESCRIPCIÓN	BAV4BM €
BAV4BM	10X35mm	10,73

BROCAS AVELLANADORAS PARA TUBO Y CHAPA HSS Y HSSCO

**HSS** **HSSCo**

Ref. AV30  
Ref. AVC30

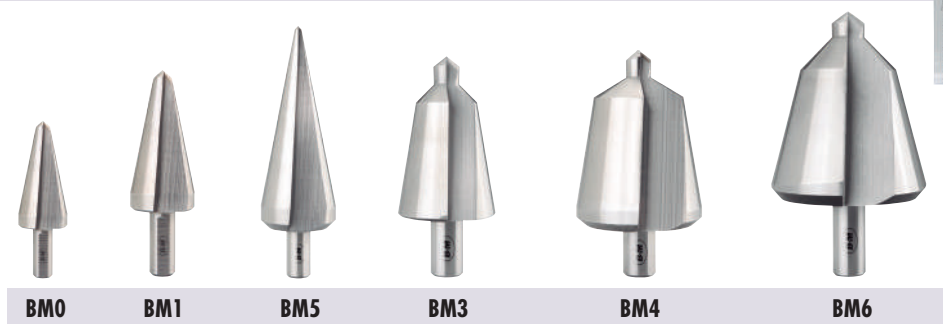

					AV30		AVC30		
D mín. mm	D máx. mm	D2 mm	L1 mm		HSS €	TiN €	HSSCo €	TiN €	
3,0	14,0	6,0	58	AV30BMOB	20,13	40,23	AVC30BMOB	37,26	48,67
3,0	22,5	8,0	85	AV30BM8B	55,65	100,85			
3,0	31,0	10,0	102	AV30BM5B	88,99	133,36			
5,0	25,4	10,0	87	AV30BM9B	63,28	120,89			
6,0	20,0	8,0	63	AV30BM1B	28,40	58,71	AVC30BM1B	49,40	75,03
16,0	30,0	10,0	79	AV30BM2B	54,93	97,15	AVC30BM2B	81,51	108,68
26,0	40,0	13,0	86	AV30BM3B	113,65	177,97	AVC30BM3B	164,73	228,88
36,0	50,0	13,0	89	AV30BM4	167,40	258,22			
40,0	61,0	13,0	98	AV30BM6	277,32	431,87			

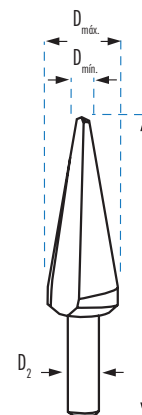

\*Las referencias acabadas en B, se suministran en blíster.

BROCAS AVELLANADORAS PARA CHAPA HSS CARACTERISTICAS ESPECIALES

**HSS** Ref. AG Broca-avellanadora para cortar tubo y chapa de acero y aleaciones ligeras, materiales plásticos. Indicado hasta 5 mm de profundidad.

**HSS** Ref. AV31

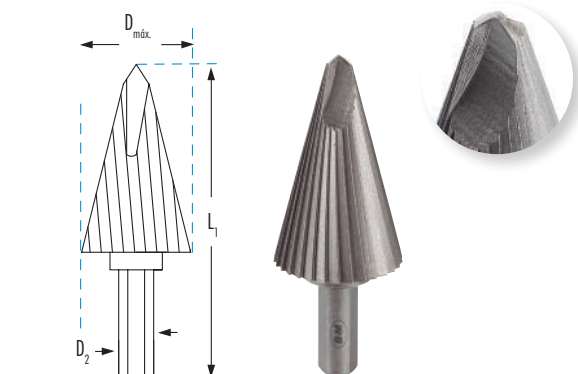

FRESA PARA TUBO Y CHAPA

TOPE DE PROFUNDIDAD

					AG
	D máx. mm	D2 mm	L1 mm	Nº dientes	HSS €
AG2500	25,0	8,0	72	20	28,42
AG3200	32,0	10,0	81	30	42,67
AG4500	45,0	10,0	94	36	70,48

					AV31	
	D mín. mm	D máx. mm	D2 mm	L1 mm	HSS €	TiN €
AV31BMOB	3,0	7,8	6,0	48	32,26	48,82
AV31BM1B	3,0	10,2	6,0	52	42,36	66,41
AV31BM2B	3,0	11,8	6,0	56	47,14	83,31





**AVELLANADORES 3/5 CANALES  
ÚLTIMA GENERACIÓN**

**NEW**

DIN  
335C

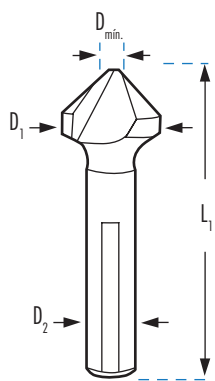
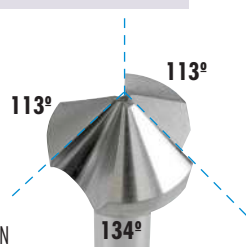

				AV66	AV67	AV99	AV55	AV6MD	AV66MD	AV55MD
MATERIAL				HSSCo	HSSCo	HSSCo	HSSCo	MD	MD	MD
ACABADO					TiAlN	TiAlN				
APLICACIÓN						INOX <i>Superfines</i>	HARDOX 500	ALTA PRODUCCIÓN		HARDOX 500
				3Z	3Z	3Z	5Z	3Z	3Z	5Z
D1 mm	D mín. mm	D2 mm	L1 mm	€	€	€	€	€	€	€
4,30	1,3	4,0	40					67,74		
5,30	1,5	4,0	40					65,22		
6,00	1,5	5,0	45					67,39		
6,30	1,5	5,0	45	22,46	29,19	41,70	4Z 29,19	72,86	81,35	4Z 101,69
8,00	2,0	6,0	50			54,96		77,62		
8,30	2,0	6,0	50	24,19	31,44	56,25	4Z 31,44	82,78	92,43	4Z 115,53
10,00	2,5	6,0	50			60,36		85,56		
10,40	2,5	6,0	50	29,11	37,85	63,85	4Z 37,85	90,29	100,81	4Z 126,01
11,50	2,8	8,0	56			68,55				
12,40	2,8	8,0	56	31,10	40,43	69,41	40,43	94,15	105,12	131,40
14,40	2,4	8,0	56	37,36	48,57					
15,00	3,2	10,0	60	43,21	56,18	85,86		98,06		
16,50	3,2	10,0	60	43,65	56,74	96,83	56,74	103,11	115,13	143,91
19,00	3,5	10,0	63			109,80				
20,50	3,5	10,0	63	57,73	75,05	119,75	75,05	142,97	159,63	199,54
23,00	3,8	10,0	67			130,15				
25,00	3,8	10,0	67	79,28	103,06	140,91	103,06	233,30	260,48	325,59
31,00	4,2	12,0	71	110,16	143,21	170,32	143,21	263,25	293,92	367,40
40,00	6,5	13,0	80	231,79	301,32	324,82		457,06*		
50,00	5,0	16,0	125	355,36	461,97					

\* Mango de 16 mm



**Avellanadores de Corte Variable Antivibración.**

Avellanadores de nueva Generación, mejoran la calidad del acabado en la operación y alargan su vida útil.

La ligera asimetría en los cortes del avellanador, aumenta el rendimiento y disminuye significativamente las vibraciones durante la operación.

La disposición de los cortes en el avellanador, contribuye a una operación de corte progresiva, aumenta el rendimiento de la herramienta, mejorando el acabado final, minimizando las irregularidades.

Los tres planos de arrastre previenen el deslizamiento, asegurando un amarre firme del avellanador en el portabrocas evitando posibles patinazos y deslizamientos durante su uso.

**HARDOX  
500**

Avellanado de HARDOX500 y Materiales de Extrema Dureza.

Para avellanados en materiales de Alta Dureza y HARDOX500, se recomiendan los avellanadores AV55 y AV55MD de 5Z.

**Modo de Actuación:** Es muy importante, en este tipo de materiales, que antes de comenzar a rotar el avellanador para empezar a cortar, la herramienta ya esté en contacto con el material. Posteriormente, comienza a girar e incrementa la velocidad de manera progresiva mientras empieza a penetrar en el material. De esta manera, se evita cualquier choque inicial, donde existe una alta posibilidad de despuntar el filo de corte en la aproximación de la herramienta.

## AVELLANADORES HSS MANGO CILÍNDRICO 60°, 75°, 120°

3Z

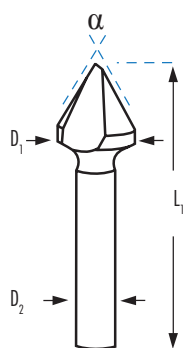

				AV8		AV9		AV10	
MATERIAL				HSS		HSS		HSS	
NORMA				DIN 334C		NORMA CELESA		NORMA CELESA	
ÁNGULO DE PUNTA				60°		75°		120°	
D1 mm	D mín mm	D2 mm	L1 mm	€		€		€	
6,30	1,5	5,0	45	AV80630	20,66	AV90630	15,90	AV100630	16,93
8,00	2,0	6,0	50	AV80800	22,71				
8,30	2,0	6,0	50			AV90830	21,68	AV100830	23,33
10,00	2,5	6,0	50	AV81000	24,77				
10,40	2,5	6,0	50			AV91040	25,62	AV101040	27,26
12,40	2,8	8,0	56	AV81250	27,47	AV91240	28,30	AV101240	32,64
16,50	3,2	10,0	60	AV81600	35,13	AV91650	35,50	AV101650	41,30
20,50	3,5	10,0	63	AV82000	49,58	AV92050	52,26	AV102050	60,93
25,00	3,8	10,0	67	AV82500	69,20	AV92500	65,88	AV102500	76,85
40,00	6,5	13,0	67	AV84000	158,97	AV94000	143,33	AV104000	168,91

## AVELLANADORES MULTICORTE MANGO CILÍNDRICO 60°, 90° Y 120°

5Z

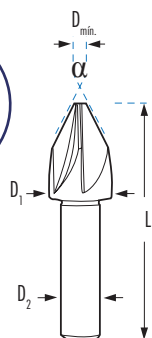

				AV12		AV11		AV13				
MATERIAL				HSS		HSS		HSS				
DIN				DIN 334A		DIN 335A		DIN 347A				
ÁNGULO DE PUNTA				60°		90°		120°				
D1 mm	D mín mm	D2 mm	Nº Z	L1 mm	€	L1 mm	€	L1 mm	€			
8,00	2,5	8,0	5	AV120800	48	18,06	AV110800	44	13,58	AV130800	44	17,99
12,50	2,8	8,0	5	AV121250	52	25,27	AV111250	48	19,89	AV131250	48	26,42
16,00	3,0	10,0	5	AV121600	60	42,39	AV111600	56	33,39	AV131600	56	44,32
20,00	3,5	10,0	5	AV122000	64	54,68	AV112000	60	43,01	AV132000	60	57,14
25,00	3,5	10,0	5	AV122500	69	76,54	AV112500	65	60,21	AV132500*	65	77,73

\* D2: 12,00 mm

AVELLANADORES HSS Y HSSCO PARA DESBARBAR CON AGUJERO

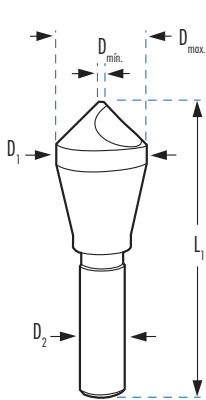

MATERIAL					AV1		AV1T		AV2		AV2T		AV1-60	
ACABADO					HSS		HSS		HSSCo		HSSCo		HSS	
ÁNGULO DE PUNTA					90°		TiN 90°		90°		TiN 90°		60°	
D1 mm	Dmin mm	Dmax mm	D2 mm	L1 mm	€	€	€	€	€	€	€	€	€	
6,35	2,0	5,0	6,35	45	AV100	14,74	AV100T	26,63	AV200	25,05	AV200T	42,14	AV100-60	26,40
10,00	2,0	5,0	6,00	45	AV101	18,17	AV101T	27,85	AV201	25,87	AV201T	42,14	AV101-60	32,98
14,00	6,0	13,0	8,00	50	AV102	22,70	AV102T	39,15	AV202	30,13	AV202T	52,54	AV102-60	40,04
20,00	8,0	18,0	10,00	65	AV103	40,64	AV103T	70,00	AV203	53,86	AV203T	88,93	AV103-60	45,67
27,00	11,0	25,0	12,00	85	AV104	72,64	AV104T	115,07	AV204	87,76	AV204T	140,10	AV104-60	79,57
30,00	12,0	28,0	15,00	95	AV105	122,59	AV105T	218,37	AV205	139,43	AV205T	240,73	AV105-60	130,40
35,00	14,0	33,0	15,00	100	AV106	188,28	AV106T	299,01	AV206	233,61	AV206T	404,84	AV106-60	206,65
40,00	16,0	38,0	15,00	110	AV107	259,96	AV107T	424,96	AV207	268,79	AV207T	433,74	AV107-60	280,07
45,00	18,0	42,0	15,00	120	AV108	344,44	AV108T	516,12	AV208	403,95	AV208T	575,41	AV108-60	361,96
50,00	20,0	48,0	15,00	130	AV109	415,59	AV109T	600,06	AV209	538,38	AV209T	722,42	AV109-60	441,04

AVELLANADOR CÓNICO 90° MULTILABIO

Ref. FC

TiAlN

MD

							FC
D1 mm	D2 mm	L mm	L2 mm	D3 mm	Z		€
0,5	0,1	39,0	3,0	3,0	3	FC0050	65,87
0,6	0,1	39,0	3,0	3,0	3	FC0060	65,87
0,7	0,1	39,0	3,0	3,0	3	FC0070	65,87
0,8	0,1	39,0	3,0	3,0	3	FC0080	65,87
0,9	0,1	39,0	3,0	3,0	3	FC0090	65,87
1,0	0,1	39,0	3,0	3,0	3	FC0100	63,59
1,5	0,1	39,0	4,5	3,0	3	FC0150	63,59
2,0	0,1	39,0	6,0	3,0	3	FC0200	63,59
2,5	0,1	39,0	7,5	3,0	3	FC0250	63,59
3,0	0,1	39,0	-	3,0	3	FC0300	63,59
4,0	0,8	54,0	-	4,0	4	FC0400	65,87
6,0	0,8	57,0	-	6,0*	4	FC0600	69,27
8,0	0,8	63,0	-	8,0*	5	FC0800	76,09
10,00	1,0	72,0	-	10,0*	6	FC1000	90,85
12,00	1,2	83,0	-	12,0*	6	FC1200	134,00
16,00	1,6	92,0	-	16,0*	6	FC1600	239,61
20,00	2,0	104,0	-	20,0*	6	FC2000	438,33

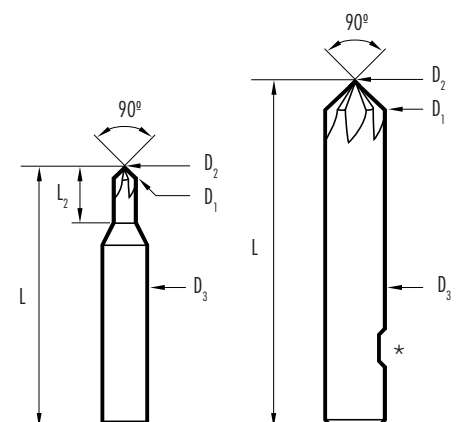

\*Con plano de arrastre

**AVELLANADORES CON MANGO CÓNICO**
**3Z**

Ref. AV17

**DIN  
335D**
**HSS**

**90°**

Ref. AV17MD

**DIN  
335D**
**MD**

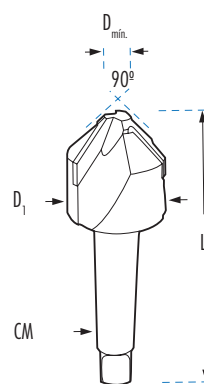
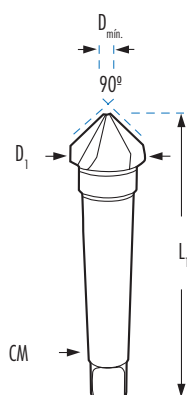
**90°**

**AV17**

D1 mm	D mín. mm	L1 mm	CM	€
16,50	4,0	90	1	86,57
20,50	3,5	100	2	102,06
25,00	3,8	106	2	103,11
31,00	4,2	112	2	114,77
40,00	10,0	140	3	176,62
50,00	14,0	150	3	222,34
63,00	16,0	180	4	359,49
80,00	22,0	190	4	615,10
100,00	25,0	210	4	1.585,27

**AV17MD**

D1 mm	D mín. mm	L1 mm	CM	€
63,00	16,0	190	4	1.504,61*
80,00	22,0	190	4	1.836,84*

\*Hasta fin de existencias

**AVELLANADORES MULTICORTE CON MANGO CÓNICO**
**MULTI  
CORTE**

Ref. AV23

**DIN  
334B**

**60°**

Ref. AV18

**DIN  
335B**

**90°**

Ref. AV24

**DIN  
347B**

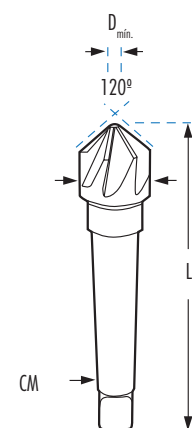
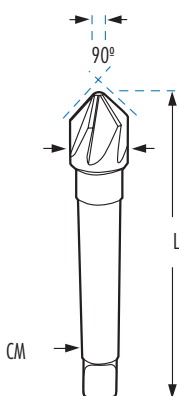
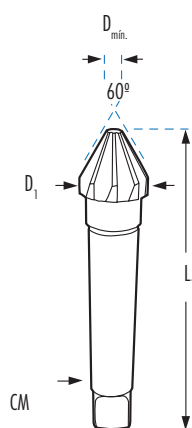
**120°**

**AV23**

D1 mm	D mín. mm	L1 mm	CM	Z	HSS	€
16,00	3,2	93	1	7	HSS	65,68
20,00	4,0	116	2	7	HSS	76,89
25,00	7,0	121	2	9	HSS	84,22
31,50	9,0	124	2	9	HSS	115,16
40,00	12,5	150	3	11	HSS	210,77
50,00	16,0	153	3	13	HSS	251,95
63,00	20,0	185	4	15	HSS	385,70
80,00	25,0	196	4	17	HSS	596,10

**AV18**

D1 mm	D mín. mm	L1 mm	CM	Z	HSS	€
16,00	3,2	93	1	7	HSS	66,99
20,00	4,0	116	2	7	HSS	78,34
25,00	7,0	121	2	9	HSS	85,91
31,50	9,0	124	2	9	HSS	117,50
40,00	12,5	150	3	11	HSS	215,03
50,00	16,0	153	3	13	HSS	256,92
63,00	20,0	185	4	15	HSS	368,86
80,00	25,0	196	4	17	HSS	608,07
100,00	22,0	190	4	20	HSS	1.639,13

**AV24**

D1 mm	D mín. mm	L1 mm	CM	Z	HSS	€
16,00	3,2	93	1	7	HSS	68,22
20,00	4,0	116	2	7	HSS	79,84
25,00	7,0	121	2	9	HSS	91,69
31,50	9,0	124	2	9	HSS	119,61
40,00	12,5	150	3	11	HSS	190,46
50,00	16,0	153	3	13	HSS	246,01
63,00	20,0	185	4	15	HSS	400,53
80,00	25,0	196	4	17	HSS	619,03
100,00	27,0	210	4	3	HSS	1.624,65

**AVELLANADORES DE 1 CANAL**

**HSS**

**MANGO CILÍNDRICO**  
Ref. AV27  
Ref. AV29



90°



60°

**HSS**

**MANGO CÓNICO**  
Ref. AV34  
Ref. AV28



90°



60°



**1Z**

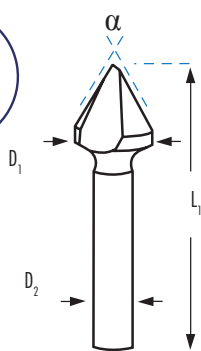

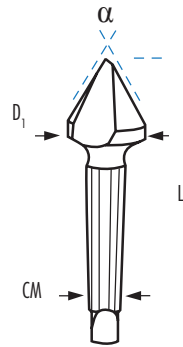

**1Z**





**AV27**

**AV29**

	D1 mm	D2 mm	L1 mm	 €	 €
AV270600	6,0	5,0	45	14,18	AV290600 26,16
AV270800	8,0	6,0	46	14,98	AV290800 27,40
AV271000	10,0	8,0	46	15,87	AV291000 28,69
AV271200	12,0	8,0	46	18,48	AV291200 32,23
AV271600	16,0	8,0	46,5	22,01	AV291600 39,24
AV272000	20,0	10,0	47	30,08	AV292000 50,44
AV272500	25,0	10,0	51	39,62	AV292500 79,42
AV273000	30,0	12,0	71	57,15	AV293000 103,72
AV274000	40,0	13,0	89	148,93	AV294000 180,29
AV275000	50,0	13,0	98	183,87	AV295000 269,35

**AV34**

**AV28**

	D1 mm	CM	L1 mm	 €	 €
AV341600	16,0	1	92	68,19	AV281600 65,24
AV342000	20,0	2	107	85,46	AV282000 71,47
AV342500	25,0	2	110	110,05	AV282500 105,97
AV343000	30,0	2	114	125,05	AV283000 139,64
AV344000	40,0	3	145	201,21	AV284000 183,86
AV345000	50,0	3	152	293,81	AV285000 279,21



**AVELLANADORES EXTERNOS DE 3 CORTES**
**3Z**

Ref. AVX

HSS



90°

Ref. AVX-60

HSS



60°

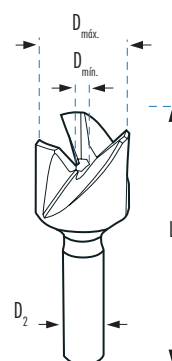

AVX					
Dmáx. mm	Dmín. mm	D2 mm	L1 mm		€
12,00	4,0	8,0	55	AVX1	59,35
20,00	8,0	10,0	60	AVX2	110,56
28,00	10,0	13,0	70	AVX3	156,84
40,00	12,0	CM2	125	AVX4	238,00
50,00	15,0	CM3	130	AVX5	332,51

AVX-60					
Dmáx. mm	Dmín. mm	D2 mm	L1 mm		€
8,00	3,0	8,0	55	AVX1-60	63,40
15,00	6,0	10,0	60	AVX2-60	121,66
28,00	10,0	13,0	75	AVX3-60	182,33

**AVELLANADOR EXTERNO PARA REPARACIÓN DE HILOS DE ENTRADA**

Ref. AVEXT

HSS



60°



Min.-Max.		L1 mm		€
M8-M18	1/4"	75	AVEXT	28,11

**AVELLANADOR EXTERNO DE METAL DURO PARA REPARACIÓN DE HILOS DE ENTRADA**
**NEW**

Ref. AVMDEXT

MD



60°

INOX



Min.-Max.			€
5-25 mm	1/4"	AVMDEXT	32,36

**AVELLANADORES PARA ASIENTOS DE TORNILLOS «ALLEN»**

**MANGO CILÍNDRICO**

**DIN 373**

**HSS**

Ref. AV2

NOTA: La longitud de corte se entiende sin la guía.

\* El ajuste grueso se utiliza para avellanar agujeros roscados.

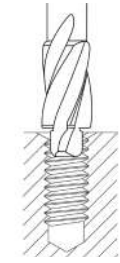
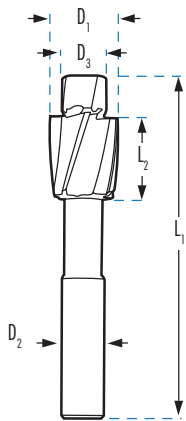

Para avellanar Orificios roscados



**AV2M**

**AV2MM**

**AV2GM**

AJUSTE						FINO		MEDIO		AGUJERO ROSCADO			
	D1 mm	D2 mm	L1 mm	L2 mm		D3 mm	€	D3 mm	€	D3 mm	€		
M3	6,0	5,0	71	14	AV2M3	3,2	25,59	AV2MM3	3,4	27,70	AV2GM3	2,5	27,70
M4	8,0	5,0	71	14	AV2M4	4,3	25,59	AV2MM4	4,5	27,70	AV2GM4	3,3	27,70
M5	10,0	8,0	80	18	AV2M5	5,3	25,59	AV2MM5	5,5	27,70	AV2GM5	4,2	27,70
M6	11,0	8,0	80	18	AV2M6	6,4	28,84	AV2MM6	6,6	31,22	AV2GM6	5,0	31,22
M7	20,0	12,7	90	20	AV2M7	7,4	53,25						
M8	15,0	12,5	100	22	AV2M8	8,4	35,75	AV2MM8	9,0	38,70	AV2GM8	6,8	38,70
M10	18,0	12,5	100	22	AV2M10	10,5	42,56	AV2MM10	11,0	46,07	AV2GM10	8,5	46,07
M11	22,0	18,8	100	22	AV2M11	11,5	56,65						
M12	20,0	12,5	100	22	AV2M12	13,0	49,65	AV2MM12	14,0	53,75	AV2GM12	10,2	53,75
M14	24,0	12,5	100	22	AV2M14	15,0	77,66	AV2MM14	15,5	84,07	AV2GM14	12,0	84,07
M16	26,0	12,5	100	22	AV2M16	17,0	85,42	AV2MM16	17,5	92,46	AV2GM16	14,0	92,46

**CABEZA CÓNICA CON GUÍA**

**DIN 1866**

**HSS**

Ref. AV3

NOTA: La longitud de corte se entiende sin la guía.

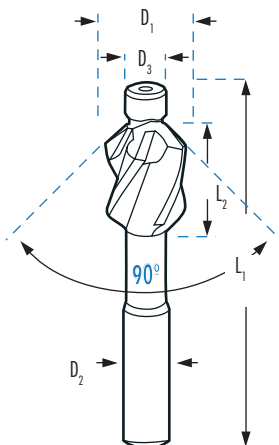

AJUSTE						AV3	
	D1 mm	D2 mm	L1 mm	L2 mm		D3 mm	FINO
M3	6,3	6,0	71	14,0	AV3M3	3,2	35,00
M4	8,3	8,0	71	14,0	AV3M4	4,3	35,00
M5	10,4	10,0	80	18,0	AV3M5	5,3	35,00
M6	12,4	10,0	80	18,0	AV3M6	6,4	39,77
M8	16,5	12,0	100	22,0	AV3M8	8,4	48,67
M10	20,5	12,0	100	22,0	AV3M10	10,5	52,65
M12	24,5	13,0	110	25,0	AV3M12	13,0	64,18

**AVELLANADORES PARA ASIENTOS DE TORNILLOS «ALLEN»**

MANGO CÓNICO

**DIN  
375**
**HSS**

Ref. AV5

NOTA: La longitud de corte se entiende sin la guía.

\* El ajuste grueso se utiliza para avellanar agujeros roscados.

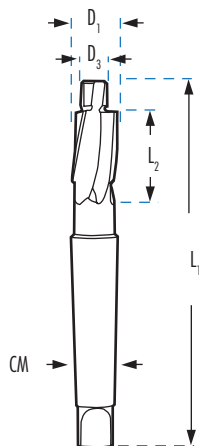
**PARA AVELLANAR  
ORIFICIOS ROSCADOS**



AJUSTE					AV5M		FINO		AV5MM		MEDIO		AV5GM		AGUJERO ROSCADO
	D1 mm	CM	L1 mm	L2 mm		D3 mm	€		D3 mm	€		D3 mm	€		€
M8	15,0	2	132	22	AV5M8	8,4	<b>69,29</b>					AV5GM8	6,8	<b>69,29</b>	
M10	18,0	2	140	25	AV5M10	10,5	<b>71,11</b>	AV5MM10	11,0	<b>71,11</b>		AV5GM10	8,5	<b>71,11</b>	
M12	20,0	2	140	25	AV5M12	13,0	<b>78,68</b>	AV5MM12	14,0	<b>78,68</b>		AV5GM12	10,2	<b>78,68</b>	
M14	24,0	2	150	30	AV5M14	15,0	<b>109,21</b>	AV5MM14	15,5	<b>109,21</b>		AV5GM14	12,0	<b>109,21</b>	
M16	26,0	3	180	35	AV5M16	17,0	<b>128,25</b>	AV5MM16	17,5	<b>128,25</b>		AV5GM16	14,0	<b>128,25</b>	
M18	30,0	3	180	35	AV5M18	19,0	<b>138,38</b>	AV5MM18	20,0	<b>138,38</b>		AV5GM18	15,5	<b>138,38</b>	
M20	33,0	3	190	40	AV5M20	21,0	<b>150,77</b>	AV5MM20	22,0	<b>150,77</b>		AV5GM20	17,5	<b>150,77</b>	
M22	36,0	3	190	40	AV5M22	23,0	<b>183,73</b>	AV5MM22	24,0	<b>183,73</b>		AV5GM22	19,5	<b>183,73</b>	
M24	40,0	3	190	40	AV5M24	25,0	<b>222,11</b>	AV5MM24	26,0	<b>222,11</b>		AV5GM24	21,0	<b>222,11</b>	
M27	46,0	4	255	50	AV5M27	30,0	<b>252,38</b>								
M30	48,0	4	255	50	AV5M30	33,0	<b>305,32</b>								

**APLICACIONES DE LOS TIPOS DE AJUSTES: FINO, MEDIO Y AGUJERO ROSCADO**

T<sub>1</sub>: Tornillos Cabeza Cilíndrica DIN 84 y DIN 7984  
 Tornillos Autorroscantes DIN 7513

T<sub>2</sub>: Tornillos Cabeza Cilíndrica DIN 6912

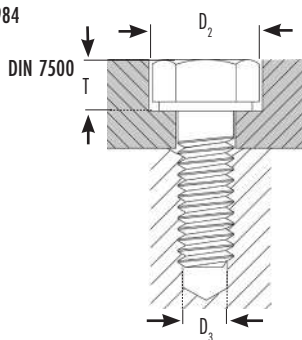
T<sub>3</sub>: Tornillos Cabeza Cilíndrica DIN 912



	FINO	MEDIO	AGUJERO ROSCADO				
ROSCAS MÉTRICAS	D3 mm	D3 mm	D3 mm	D2 mm	T1 mm	T2 mm	T3 mm
M3	3,2	3,4	2,5	6,0	2,4	--	3,4
M4	4,3	4,5	3,3	8,0	3,2	3,4	4,6
M5	5,3	5,5	4,2	10,0	4,0	4,2	5,7
M6	6,4	6,6	5,0	11,0	4,7	4,8	6,8
M8	8,4	9,0	6,8	15,0	6,0	6,0	6,0
M10	10,5	11,0	8,5	18,0	7,0	7,5	11,0
M12	13,0	13,5	10,2	20,0	8,0	8,5	13,0
M14	15,0	15,5	12,0	24,0	9,0	9,5	15,0
M16	17,0	17,5	14,0	26,0	10,5	11,5	17,5
M18	19,0	20,0	15,5	30,0	11,5	12,5	19,5
M20	21,0	22,0	17,5	33,0	12,5	13,5	21,5
M22	23,0	24,0	19,5	36,0	13,5	14,5	23,5

## AVELLANADORES CON ELEMENTOS INTERCAMBIABLES PARA ASIENTOS DE TORNILLOS CON CABEZA "ALLEN" Y CÓNICA

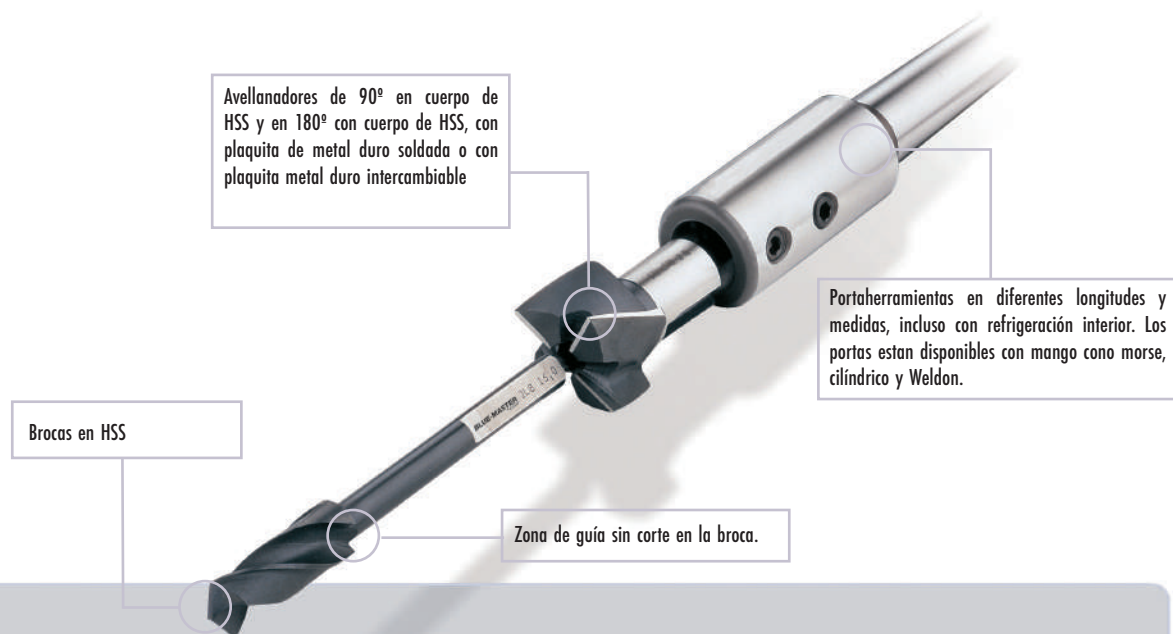

### EL SISTEMA BLUEMASTER

El sistema BLUEMASTER es único para operaciones de cajeado y avellanado, ayudándole a incrementar su productividad y disminuir sus costes.

Nuestros portaherramientas, fresas, brocas y guías pueden combinarse para adaptarlos a todo tipo de máquinas y aplicaciones.

Usted puede componer fácilmente más de 1.500.000 de herramientas especiales con sólo 1.300 piezas.

El sistema consta de 3 grupos de dimensiones: **SERIE A, SERIE B y SERIE C.**

Todas las combinaciones tienen que hacerse con elementos que pertenezcan al mismo grupo. Herramientas de distintos grupos no son combinables entre sí.

En las siguientes páginas encontrará tanto los rangos de medidas disponibles en cada grupo, así como recomendaciones para la correcta elección tanto de la herramienta como de los datos de corte.

**Importante!**

- \* Usando corte de metal duro colocar el tornillo de ajuste axial en contacto con la guía o broca insertada.
- \* Dejar un espacio entre el filo y la guía o broca para prevenir roturas por impacto accidental.
- \* El tornillo axial también se usa para prolongar la vida de las brocas tras reafiladas.

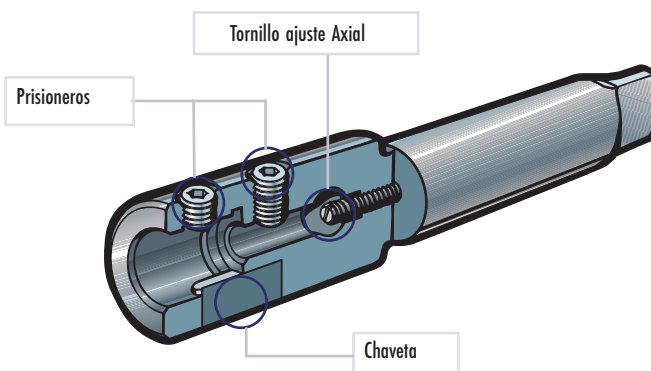

### DIMENSIONES DE GUÍA, PORTA Y BROCA

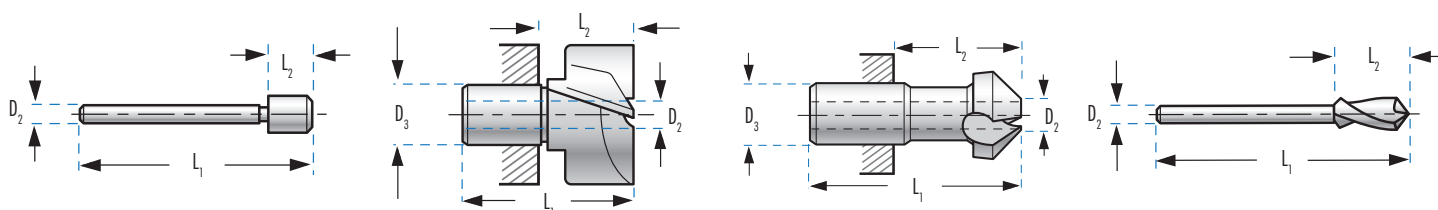

	GUÍA				PORTAS					AVELLANADOR					BROCA		
	D2 mm	L1 mm	L2 mm		D3 mm	D2 mm	L1 mm	L2 mm		D3 mm	D2 mm	L1 mm	L2 mm		D2 mm	L1 mm	L2 mm
<b>AGP</b>	4	64	9	<b>APAV-MD-PQ</b>	10	4	40	22	<b>AVC</b>	10	4	40	22	<b>ABP</b>	4	70	15
<b>BGP</b>	6	80	14	<b>BPAV-MD-PQ</b>	14	6	48	28	<b>BVC</b>	14	6	48	28	<b>BBP</b>	6	95	25
<b>CGP</b>	10	110	20	<b>CPAV-MD-PQ</b>	22	10	61	33	<b>CVC</b>	22	10	61	33	<b>CBP</b>	10	125	30

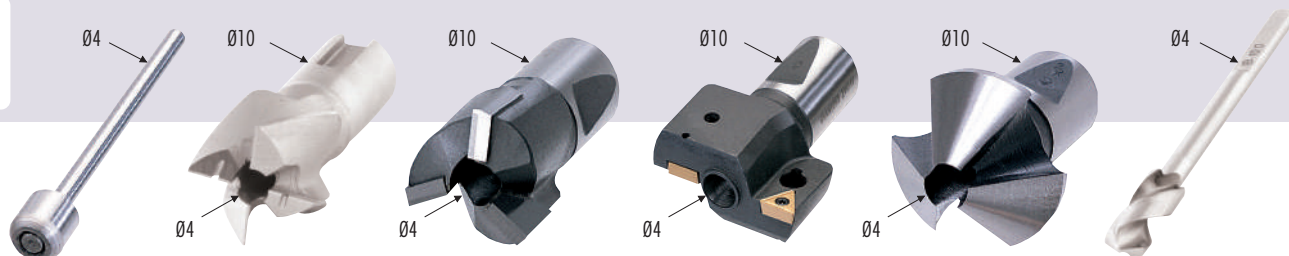
**AVELLANADORES CON ELEMENTOS INTERCAMBIABLES PARA  
ASIENTOS DE TORNILLOS CON CABEZA "ALLEN" Y CÓNICA**
**SERIE  
A**

GUÍA

PORTA

PORTA

PLAQUITA INTERCAMBIABLE

AVELLANADOR

BROCA

AGP

APAV

APAVMD

APAVPQ

AVC

ABP

€

**HSS**  
€

€

 Plaquita  
no incluida  
PMD  
€

**HSS**  
€

**HSS**  
€
AGP0400 **46,64**AGP0450 **55,62**AGP0550 **55,62**AGP0600 **55,62**AGP0650 **55,62**AGP0640 **55,62**AGP0660 **55,62**AGP0500 **55,62**APAV0700 **142,35**APAV0800 **140,63**APAV0900 **140,63**APAV1000 **136,12**APAV1100 **140,63**APAV1150 **155,49**APAV1200 **142,35**APAV1250 **157,90**APAV1300 **155,15**APAV1350 **178,63**APAV1400 **155,15**APAV1450 **178,98**APAVMD1000 **399,78**APAVMD1100 **399,78**APAVMD1200 **399,78**APAVMD1300 **399,78**APAVMD1400 **403,56**APAVMD1500 **408,06**APAVMD1600 **417,40**APAVMD1700 **426,39**APAVMD1800 **435,34**APAVMD1900 **455,03**APAVMD2000 **464,73**APAVMD2100 **486,81**AVC0800 **185,52**AVC1000 **185,52**AVC1200 **188,29**AVC1150 **182,08**AVC1240 **190,48**AVC1350 **190,48**AVC1400 **204,20**AVC1500 **205,91**AVC1600 **206,96**AVC1650 **201,45**APAVPQ1800 **909,39**APAVPQ2000 **1.019,28**ABP0430 **80,83**ABP0450 **80,83**ABP0500 **80,83**ABP0530 **80,83**ABP0550 **80,83**ABP0600 **95,01**ABP0640 **95,01**ABP0650 **95,01**ABP0660 **95,01**ABP0700 **95,01**AGP0840 **56,33**AGP0900 **56,33**AGP0680 **55,62**AGP0700 **55,62**AGP0750 **55,62**AGP0800 **56,33**AGP0850 **56,33**AGP0900 **56,33**AGP0950 **56,33**AGP1000 **56,33**AGP1050 **56,33**AGP1100 **56,33**AGP1150 **56,33**
**ADAPTADORES**

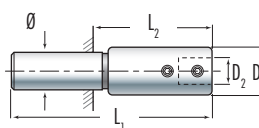
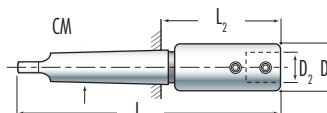
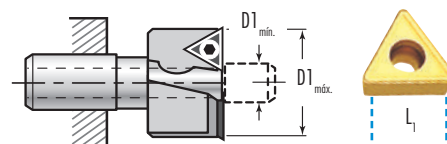

	D1 mm	D2 mm	L1 mm	L2 mm	CM Ø mm	APH €
APHCM1	18	10	110	48	CM1	<b>333,41</b>
APHCM2	18	10	132	57	CM2	<b>327,20</b>
APH-10	18	10	92	42	Ø10	<b>311,65</b>

**PLAQUITAS DE REPUESTO**

	L1 mm	D1 mín. Ømm	D1 máx. Ømm	PPQ €
PPQ07	7	18	20	<b>34,56</b>

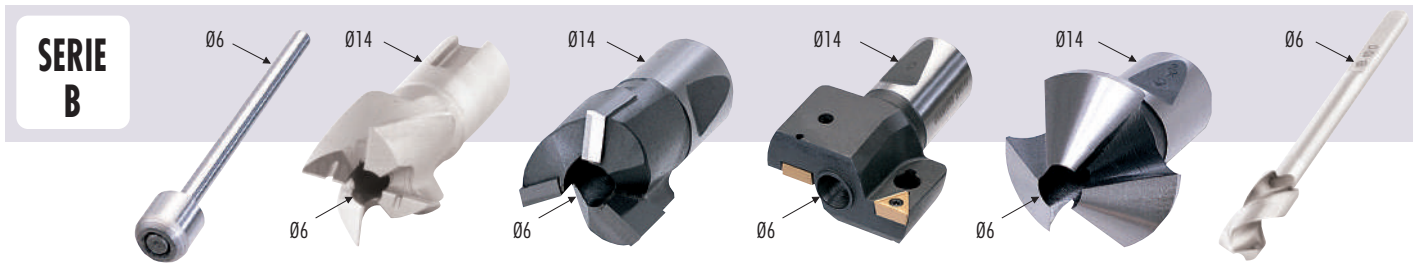

**AVELLANADORES CON ELEMENTOS INTERCAMBIABLES PARA ASIENTOS DE TORNILLOS CON CABEZA "ALLEN" Y CÓNICA**



SERIE B		GUÍA	PORTA	PORTA	PLAQUITA INTERCAMBIABLE	AVELLANADOR	BROCA
		BGP	BPAV	BPAVMD	BPAVPQ	BVC	BBP
			HSS	MD	Plaquita no incluida	90°	HSS
		€	€	€	€	€	€
			BPAV1300 <b>157,56</b>	BPAVMD1300 <b>426,39</b>			
			BPAV1350 <b>177,92</b>				
			BPAV1400 <b>157,56</b>	BPAVMD1400 <b>426,39</b>			
			BPAV1450 <b>177,92</b>				BBP0800 <b>112,99</b>
BGP0840	<b>52,52</b>						
BGP0900	<b>52,52</b>	BPAV1500	<b>157,56</b>	BPAVMD1500	<b>426,39</b>	BVC15	<b>195,57</b>
BGP0680	<b>52,52</b>						BBP0900 <b>112,99</b>
BGP0800	<b>52,52</b>						
BGP1000	<b>52,52</b>	BPAV1550	<b>180,35</b>				
BGP1150	<b>55,62</b>	BPAV1600	<b>166,21</b>	BPAVMD1600	<b>442,25</b>		BBP0840 <b>112,99</b>
BGP1250	<b>57,00</b>	BPAV1650	<b>192,79</b>				BBP0850 <b>112,99</b>
BGP1350	<b>63,57</b>	BPAV1700	<b>173,09</b>	BPAVMD1700	<b>442,25</b>		BBP0950 <b>112,99</b>
BGP1450	<b>64,25</b>	BPAV1750	<b>194,16</b>				BBP1000 <b>128,87</b>
		BPAV1900	<b>199,71</b>	BPAVMD1900	<b>446,08</b>		BBP1050 <b>128,87</b>
BGP1050	<b>55,62</b>						
BGP1100	<b>55,62</b>	BPAV1800	<b>179,67</b>	BPAVMD1800	<b>446,08</b>		
BGP0850	<b>52,52</b>					BVC20	<b>221,12</b>
BGP1300	<b>63,57</b>						
BGP1400	<b>64,25</b>	BPAV2000	<b>199,71</b>	BPAVMD2000	<b>459,88</b>	BPAVPQ2000	<b>910,15</b>
BGP1020	<b>55,62</b>					BVC25	<b>230,13</b>
BGP1500	<b>64,25</b>						
BGP1550	<b>64,25</b>	BPAV2400	<b>236,00</b>	BPAVMD2400	<b>488,57</b>	BPAVPQ2400	<b>911,32</b>
BGP1200	<b>55,62</b>					BVC28	<b>267,77</b>
BGP1700	<b>64,25</b>						
BGP1750	<b>64,25</b>	BPAV2600	<b>252,22</b>	BPAVMD2600	<b>491,33</b>	BPAVPQ2600	<b>1.044,89</b>
BGP1400	<b>64,25</b>					BVC30	<b>273,66</b>
BGP1900	<b>65,64</b>						
BGP2000	<b>81,89</b>	BPAV3000	<b>340,67</b>	BPAVMD3000	<b>535,91</b>	BPAVPQ3000	<b>1.044,89</b>
		BPAV3400	<b>402,85</b>	BPAVMD3400	<b>618,08</b>	BPAVPQ3400	<b>1.206,05</b>

**ADAPTADORES**

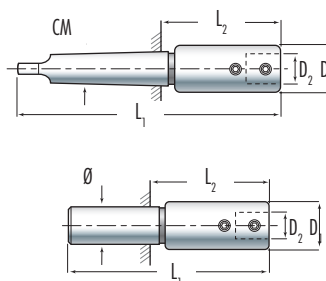

BPH						
	D1 mm	D2 mm	L1 mm	L2 mm	CM Ømm	€
BPHCM1	24	14	123	62	CM1	<b>369,72</b>
BPHCM2	24	14	137	62	CM2	<b>337,57</b>
BPHCM3	24	14	160	66	CM3	<b>369,72</b>
BPH-12	24	14	120	55	Ø12	<b>333,75</b>

**PLAQUITAS DE REPUESTO**

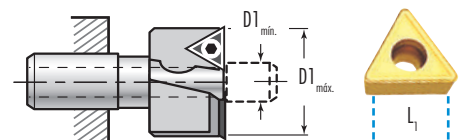

PPQ				
	L1 mm	D1 mín. Ømm	D1 máx. Ømm	€
PPQ07	7	20	25	<b>34,56</b>
PPQ10	10	26	33	<b>31,11</b>
PPQ12	12	34	36	<b>31,11</b>

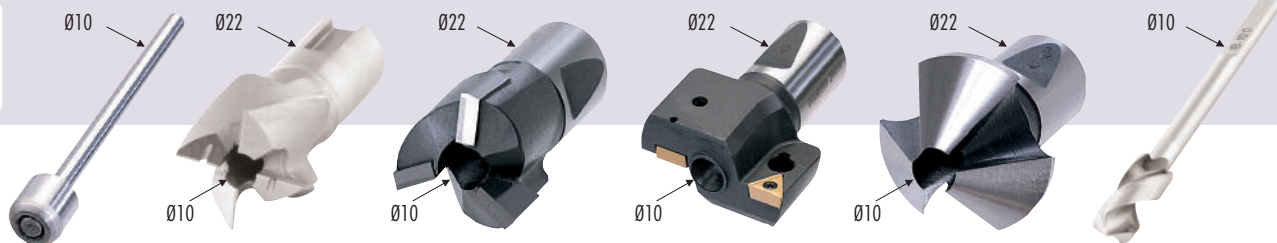
**AVELLANADORES CON ELEMENTOS INTERCAMBIABLES PARA ASIENTOS DE TORNILLOS CON CABEZA "ALLEN" Y CÓNICA**
**SERIE C**

GUÍA

PORTA

PORTA

PLAQUITA INTERCAMBIABLE

AVELLANADOR

BROCA

CGP

CPAV

CPAVMD

CPAVPQ

CVC

CBP

€	HSS €	MD €	Plaquita no incluida	PMD €	90° HSS €	HSS €						
CGP1200	59,77	CPAV2300	286,08	CPAVMD2300	533,12							
CGP1250	59,77	CPAV2400	289,86	CPAVMD2400	527,59							
CGP1300	59,77	CPAV2500	313,40	CPAVMD2500	528,64							
CGP1350	59,77	CPAV2600	319,61	CPAVMD2600	543,15							
CGP1400	70,14	CPAV2700	324,09									
CGP1450	70,14	CPAV2800	330,31	CPAVMD2800	548,33					CBP1700	282,30	
CGP1500	70,14	CPAV2900	338,25							CBP1800	318,21	
CGP1600	70,14	CPAV3100	367,63							CBP1900	333,75	
CGP1650	70,14	CPAV3200	379,72	CPAVMD3200	598,77					CBP2100	361,77	
CGP1700	70,14	CPAV3300	383,16							CBP2300	435,34	
CGP1900	70,14											
CGP2000	70,14	CPAV3000	342,73	CPAVMD3000	604,65				CVC35	399,06	CBP2000	361,77
CGP1550	70,14											
CGP2100	78,09											
CGP2200	78,09	CPAV3400	387,00	CPAVMD3400	642,66	CPAVPQ3400	1.247,19	CVC37	422,22	CBP2200	403,56	
CGP1750	70,14											
CGP1850	70,14	CPAV3500	405,29									
CGP2300	78,09											
CGP2400	78,09	CPAV3600	410,14	CPAVMD3600	660,27	CPAVPQ3600	1.247,19	CVC37	422,22	CBP2400	444,70	
CGP1950	70,14											
CGP2500	78,09											
CGP2600	96,04	CPAV4000	476,13	CPAVMD4000	731,44	CPAVPQ4000	1.275,92	CVC40	448,82			
CGP2100	78,09											
CGP2200	78,09	CPAV4500	587,38			CPAVPQ4500	1.299,22					
CGP2050	78,09	CPAV5000	853,08			CPAVPQ5000	1.520,17					
		CPAV5500	898,68			CPAVPQ5500	1.795,45					
		CPAV6000	947,04			CPAVPQ6000	1.795,45					
		CPAV6500	1.065,23			CPAVPQ6500	2.053,27					

**ADAPTADORES**

	D1 mm	D2 mm	L1 mm	L2 mm	CM Ømm	CPH €
CPHCM2	36	22	160	85	CM2	486,81
CPHCM3	36	22	180	87	CM3	459,88
CPHCM4	36	22	206	89	CM4	515,50
CPHCM5	36	22	240	91	CM5	1.134,34
CPH-12	36	22	140	71	Ø20	333,75

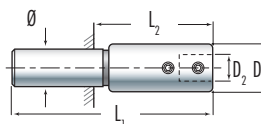
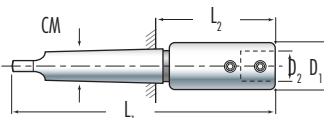
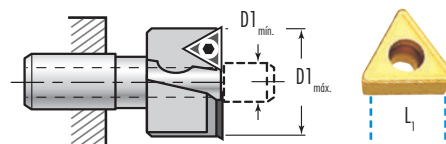
**PLAQUITAS DE REPUESTO**

	L1 mm	D1 mín. Ømm	D1 máx. Ømm	PPQ €
PPQ12	12	34	45	31,11
PPQ17	17	<46		48,20

**ESTUCHES DE AVELLANADORES**

**ESTUCHES DE BROCAS AVELLANADORAS PARA TUBO Y CHAPA HSS Y HSSCO**



Ref. PAV6CM2



Ref. PAV40BM2313

**Metal Clásico**

- Caja metálica alta resistencia

**M**



Ref. AV40BM234

Ref. AV6CM3

**Plástico Azul**

- Rígido, Robusto y Ligero
- Ventana transparente
- Plástico reforzado con goma antichoque

**P** Las Referencias que comienzan por "P" se suministran en estuche de plástico

AV40	Ref.	Uds.	CONTENIDO	HSS	TiN
				€	
	PAV40BM234	3	P AV40BM2 (4-12 mm) AV40BM3 (4-20 mm) AV40BM4 (4-30 mm)	192,40	290,24
	PAV40BM235	3	P AV40BM2 (4-12 mm) AV40BM3 (4-20 mm) AV40BM5 (6-38 mm)	309,18	427,57
	HSS PAV40BM2313	3	P AV40BM2 (4-12 mm) AV40BM3 (4-20 mm) AV40BM13 (6-40 mm)	386,72	475,50
	AV40BM234	3	M AV40BM2 (4-12 mm) AV40BM3 (4-20 mm) AV40BM4 (4-30 mm)	192,40	290,24
	AV40BM22122	3	M AV40BM2 (4-12 mm) AV40BM21 (7+10-20mm) AV40BM22 (10+20-30mm)	268,09	416,01
<b>AVC40</b>				HSSCo	TiN
HSSCo	AVC40BM234	3	M AVC40BM2 (4-12 mm) AVC40BM3 (4-20 mm) AVC40BM4 (4-30 mm)	227,65	371,75
<b>AV42</b>				HSSCo	TiN
HSSCo	AV42BM234	3	M AV42BM2 (4-12 mm) AV42BM3 (4-20 mm) AV42BM4 (4-30 mm)	218,50	324,43
<b>AV30</b>				HSS	TiN
	HSS AV30BM012	3	M AV30BM0 (3-14 mm) AV30BM1 (6-20 mm) AV30BM2 (16-30 mm)	118,93	205,33
<b>AVC30</b>				HSSCo	TiN
	HSSCo AVC30BM012	3	M AVC30BM0 (3-14 mm) AVC30BM1 (6-20 mm) AVC30BM2 (16-30 mm)	171,33	241,36



AV40BM2 AV40BM3 AV40BM4 AV40BM5 AV40BM13

AVC40BM2 AVC40BM3 AVC40BM4



AV42BM2 AV42BM3 AV42BM4



AV30BM0 AV30BM1 AV30BM2

AVC30BM0 AVC30BM1 AVC30BM2

**ESTUCHES DE AVELLANADORES**

AV16	Ref.	Uds.		CONTENIDO	€
HSS	AV16CM1	6	M	Ø 6 - 8 - 10 11,5 - 15 - 19 mm	229,08
	AV16CM2	6	M	Ø 6,3 - 8,3 - 10,4 12,4 - 16,5 - 20,5 mm	234,81
TIN	AV16CM3	7	M	Ø 6,3 - 8,3 - 10,4 12,4 - 16,5 - 20,5 - 25 mm	307,72



Ref. PAV6CM2

Ref. AV16CM3



AV6	Ref.	Uds.		CONTENIDO	€
HSS	AV6CM1	6	M	Ø 6 - 8 - 10 11,5 - 15 - 19 mm	145,16
	AV6CM2	6	M	Ø 6,3 - 8,3 - 10,4 12,4 - 16,5 - 20,5 mm	143,06
	AV6CM3	7	M	Ø 6,3 - 8,3 - 10,4 12,4 - 16,5 - 20,5 - 25 mm	196,11
	PAV6CM2	6	P	Ø 6,3 - 8,3 - 10,4 12,4 - 16,5 - 20,5 mm	143,06



AV7	Ref.	Uds.		CONTENIDO	€
HSSCo	AV7CM1	6	M	Ø 6 - 8 - 10 11,5 - 15 - 19 mm	173,41
	AV7CM2	6	M	Ø 6,3 - 8,3 - 10,4 12,4 - 16,5 - 20,5 mm	171,79
	AV7CM3	7	M	Ø 6,3 - 8,3 - 10,4 12,4 - 16,5 - 20,5 - 25 mm	237,12
	PAV7CM2	6	P	Ø 6,3 - 8,3 - 10,4 12,4 - 16,5 - 20,5 mm	171,79



AV66	Ref.	Uds.		CONTENIDO	€
HSSCo	PAV66CM2	6	P	Ø 6,3 - 8,3 - 10,4 12,4 - 16,5 - 20,5 mm	208,23

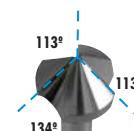

AV67	Ref.	Uds.		CONTENIDO	€
HSSCo	PAV67CM2	6	P	Ø 6,3 - 8,3 - 10,4 12,4 - 16,5 - 20,5 mm	270,70

**HARDOX**  
500



AV55	Ref.	Uds.		CONTENIDO	€
HSSCo	PAV55CM2	6	P	Ø 6,3 - 8,3 - 10,4 12,4 - 16,5 - 20,5 mm	270,70



AV6MD	Ref.	Uds.		CONTENIDO	€
MD	PAV6MDCM2	6	P	Ø 6,3 - 8,3 - 10,4 12,4 - 16,5 - 20,5 mm	586,17

**HARDOX**  
500

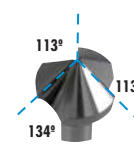
AV55MD	Ref.	Uds.		CONTENIDO	€
MD	PAV55MDCM2	6	P	Ø 6,3 - 8,3 - 10,4 12,4 - 16,5 - 20,5 mm	818,08



AV66MD	Ref.	Uds.		CONTENIDO	€
MD	PAV66MDCM2	6	P	Ø 6,3 - 8,3 - 10,4 12,4 - 16,5 - 20,5 mm	654,47



**ESTUCHES METÁLICOS DE AVELLANADORES**

DIN  
334C

AV8	Ref.	Uds.		CONTENIDO	€
	AV8CM2	6	M	Ø 6,3 - 8 - 10 12,5 - 16 - 20 mm	217,46
HSS	AV8CM3	7	M	Ø 6,3 - 8,0 - 10 12,5 - 16 - 20 - 25 mm	281,14



AV8 AV9 AV10



Ref. AV10CM6

NORMA  
CELESA

AV9	Ref.	Uds.		CONTENIDO	€
	AV9CM1	6	M	Ø 6,3 - 8,3 - 10,4 12,4 - 16,5 - 20,5 mm	222,42
HSS	AV9CM5	7	M	Ø 6,3 - 8,3 - 10,4 12,4 - 16,5 - 20,5 - 25 mm	287,82

NORMA  
CELESA

AV10	Ref.	Uds.		CONTENIDO	€
	AV10CM1	6	M	Ø 6,3 - 8,3 - 10,4 12,4 - 16,5 - 20,5 mm	250,23
HSS	AV10CM6	7	M	Ø 6,3 - 8,3 - 10,4 12,4 - 16,5 - 20,5 - 25 mm	309,74

\* Otros estuches bajo demanda AV99, etc.



AV1	Ref.	Uds.		CONTENIDO	€
HSS	AV1S2	5	M	Ø 10 - 14 20 - 27 - 30 mm	314,70



AV1

\*Hasta fin de existencias

HSS

DIN  
373

AV2M	Ref.	Uds.		CONTENIDO	€
FINO	AV2M3-10	6	M	M3-M4-M5-M6-M8-M10	187,85
	AV2M3-12	7	M	M3-M4-M5-M6-M8-M10-M12	241,26

AV2MM	Ref.	Uds.		CONTENIDO	€
MEDIO	AV2M3-10M	6	M	M3-M4-M5-M6-M8-M10	203,37
	AV2M3-12M	7	M	M3-M4-M5-M6-M8-M10-M12	261,17

AV2GM	Ref.	Uds.		CONTENIDO	€
AGUJERO ROSCADO	AV2M3-10G	6	M	M3-M4-M5-M6-M8-M10	203,37
	AV2M3-12G	7	M	M3-M4-M5-M6-M8-M10-M12	261,17



AV2 AV2MM AV2GM



Ref. AV2M3-10



## REBARBADORES DE PRECISIÓN

### LOS REBARBADORES BLUEMASTER

Los rebarbadores BLUEMASTER se emplean para eliminar las virutas acumuladas en bordes y aristas de piezas fabricadas en metal, plástico o madera.

El sistema se completa ensamblando los tres componentes señalados: CUCHILLA + PORTACUCHILLAS + MANGO UNIVERSAL

El mango puede ser utilizado con todos los grupos de cuchillas, intercambiando oportunamente el portacuchillas para cada uno de ellos.

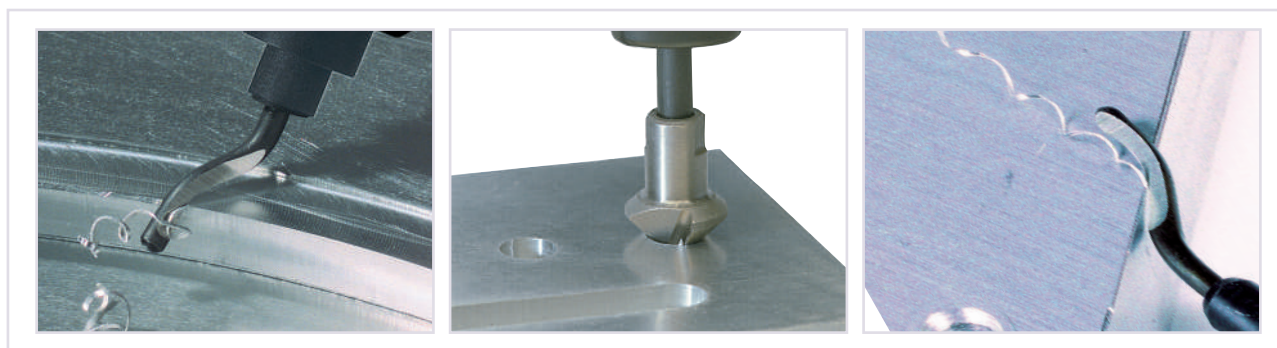
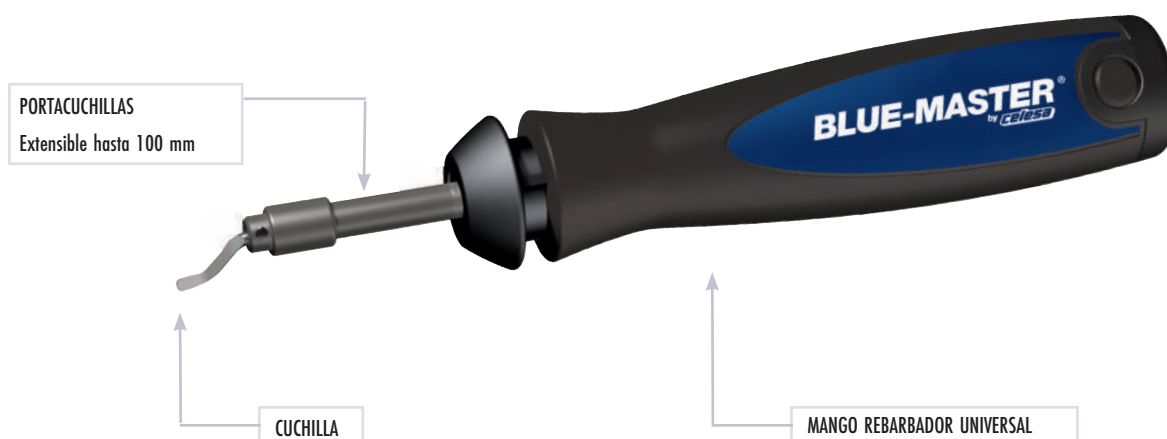

#### CONJUNTO B

**JRB1**

Contenido B:

Ref. RB10



Ref. RB20



Ref. RBB1



Ref. RBB

 Blister: **33,63 €**

#### CONJUNTO C

**JRB2**

Contenido C:

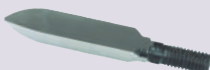

Ref. RC42



Ref. RBB1



Ref. RBC

 Blister: **61,24 €**

#### CONJUNTO D

**JRB3**

Contenido D:



Ref. RD80MD



Ref. RBB1



Ref. RBD

 Blister: **96,54 €**

#### CONJUNTO E

**JRB4**

Contenido E:



Ref. RE10

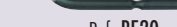

Ref. RE20

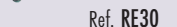

Ref. RE30



Ref. RBB1

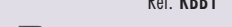

Ref. RBE

 Blister: **37,45 €**

**REBARBADORES DE PRECISI3N**

**GRUPO B**

PORTACUCHILLAS GRUPO B



Ø2,6mm

**RBB**

**11,80 €**

Para cuchillas rebarbadoras Grupo B

CUCHILLAS GRUPO B



Cuchilla rebarbadora  
Serie corta: acero, aluminio, pl3stico

**RB10\***

Blister 10 U.: **2,18 €**/U.



Cuchilla punzonadora de Metal Duro

**RB50\***

Blister 1 U.: **38,85 €**



Cuchilla rebarbadora Bidireccional  
Serie corta: lat3n, fundici3n

**RB20**

Blister 10 U.: **2,18 €**/U.



Cuchilla rebarbadora para parte posterior de un taladro de hasta 20 mm de profundidad

**RB60\***

Blister 10 U.: **5,16 €**/Ud



Cuchilla rebarbadora doble arista agujeros de 4 mm de profundidad

**RB30**

Blister 10 U.: **2,18 €**/U.



Cuchilla rebarbadora de aristas exteriores

**RB70MD\***

Blister 1 U.: **44,20 €**

\*Hasta fin de existencia

**GRUPO C**

PORTACUCHILLAS GRUPO C



Para cuchillas rebarbadoras Grupo C

**RBC**

Blister 1U.: **11,80 €**

CUCHILLAS GRUPO C



Cuchilla rasqueta ancho 4 x 20 mm

**RC40\***

Blister 1 U.: **24,06 €**



Cuchilla rasqueta ancho 8 x 30 mm

**RC42\***

Blister 1 U.: **29,93 €**

\*Hasta fin de existencia

**GRUPO D**

PORTACUCHILLAS GRUPO D



Para cuchillas rebarbadoras Grupo D

**RBD**

Blister 1 U.: **11,80 €**

CUCHILLAS GRUPO D



Cuchilla rebarbadora de metal duro en "V" Hembra cantos hasta 3 mm

**RD80MD\***

Blister 1 U.: **62,90 €**



Cuchilla rebarbadora de Metal Duro en "V" Hembra cantos hasta 8 mm

**RD82MD\***

Blister 1 U.: **98,61 €**

\*Hasta fin de existencia

**MANGO REBARBADOR UNIVERSAL**

Usos generales.  
 Válido para portacuchillas:  
 Ref. RBB / RBC / RBD / RBE / RBF

**RBB1**

 Blister 1 ud.: **15,51 €**
**REBARBADORES DE PRECISIÓN**
**GRUPO  
E**
**PORTACUCHILLAS GRUPO E**

Para cuchillas rebarbadoras Grupo E

**RBE**

 Blister 1 ud.: **11,80 €**
**CUCHILLAS GRUPO E**

Cuchilla rebarbadora  
 para interiores y exteriores  
 Serie larga: acero, aluminio, plástico

**RE10**

 Blister 10 ud.: **2,67 €/Ud**

Cuchilla rebarbadora  
 para cantos rectos: chaveteros,...

**RE35**

 Blister 10 ud.: **2,86 €/Ud**

Cuchilla rebarbadora bidireccional  
 Serie larga: latón, fundición

**RE20**

 Blister 10 ud.: **2,67 €/Ud**

Cuchilla rebarbadora  
 cerrada doble arista para  
 agujeros de 4 mm de profundidad

**RE30**

 Blister 10 ud.: **2,67 €/Ud**

Cuchilla rebarbadora para la parte  
 posterior de un taladro de hasta  
 20 mm de profundidad

**RE60\***

 Blister 5 ud.: **3,75 €/Ud**

\*Hasta fin de existencia

**GRUPO  
F**
**PORTACUCHILLAS GRUPO F**



Para cuchillas rebarbadoras Grupo F

**RBF**

 Blister 1 ud.: **11,80 €**
**CUCHILLAS GRUPO F (Rosca M05 x 0,80)**

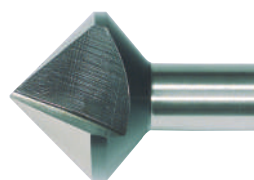

Cuchilla avellanadora HSS Ø 12 mm

**RF12**

 Blister 1 ud.: **26,55 €**

Cuchilla avellanadora HSS Ø 30 mm

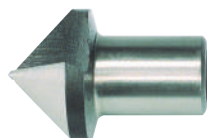
**RF30**

 Blister 1 ud.: **88,72 €**

Cuchilla avellanadora HSS Ø 20 mm

**RF20**

 Blister 1 ud.: **51,32 €**