

BLUE-MASTER[®]
by *celesa*



ESCAREADORES

BROCAS ESCALONADAS DE CANAIS RETOS HSS
HSS

Ref. AV40

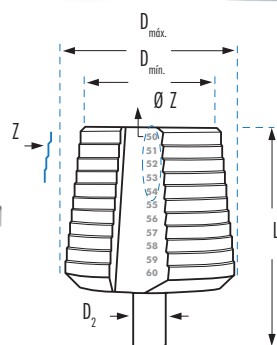
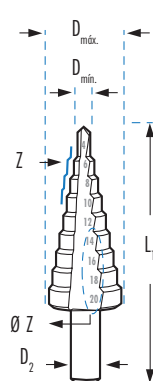
BM1
BM2
BM3
BM4
BM5

Ref. AV40BM25 / 26 / 27 / 28 / 29

AV40

	D min. mm	D max. mm	D2 mm	L1 mm	Z	Ø Z mm menor-maior	AV40	
							HSS €	TiN €
AV40BM1B	4,0	12,0	6,0	65	5	4-6-8-10-12	40,72	64,25
AV40BM2B	4,0	12,0	6,0	65	9	4-5-6-7-8-9-10-11-12	41,77	64,62
AV40BM3B	4,0	20,0	8,0	69	9	4-6-8-10-12-14-16-18-20	53,55	82,48
AV40BM4B	4,0	30,0	10,0	96	14	4-6-8-10-12-14-16-18-20-22-24-26-28-30	87,84	133,90
AV40BM14	4,0	39,0	10,0	107	13	4-6-9-12-15-18-21-24-27-30-33-36-39	217,94	336,55
AV40BM16B	5,0	28,0	10,0	69	7	5-8-8-11,8-15,3-19-24,5-28	101,09	159,09
AV40BM35B	5,0	35,0	13,0	80	13	5-7-10-12-15-17-20-22-25-27-30-32-35	130,87	190,28
AV40BM11B	6,0	25,0	10,0	65	7	6-9-12-16-20-22,50-25	82,55	111,11
AV40BM10B	6,0	26,7	10,0	75	8	6-9-11,40-14-17,25-19-21,25-26,75	160,73	252,93
AV40BM17B	6,0	30,5	10,0	80	9	6-9-12,5-15,2-18,6-20,4-22,5-28,3-30,5	170,65	268,53
AV40BM12B	6,0	32,0	10,0	75	9	6-9-12-16-20-22,5-25-28,5-32	116,51	140,22
AV40BM18B	6,0	37,0	10,0	100	12	6-9-12,5-15,2-18,6-20,4-22,5-26-28,3-30,5-34-37	189,65	293,96
AV40BM5B	6,0	38,0	10,0	96	12	6-9-13-16-19-21-23-26-29-32-35-38	204,62	271,25
AV40BM13	6,0	40,0	13,0	105	16	6-11-17-23-29-30-31-32-33-34-35-36-37-38-39-40	282,17	319,36
AV40BM15B	6,5	32,5	10,0	79	9	6,50-8,50-10,50-12,50-16,50-20,50-25,50-29-32,50	134,90	189,06
AV40BM20	6,5	40,5	10,0	96	11	6,50-8,50-10,50-12,50-16,50-20,50-25,50-29 32,50-36,50-40,50	211,49	332,81
AV40BM21B	7,0	20,0	10,0	80	12	7-10-11-12-13-14-15-16-17-18-19-20	84,62	133,16
AV40BM22B	10,0	30,0	13,0	83	12	10-20-21-22-23-24-25-26-27-28-29-30	132,46	207,81
AV40BM25B	12,0	20,0	8,0	66	9	12-13-14-15-16-17-18-19-20	78,46	105,01
AV40BM26B	20,0	30,0	10,0	78	11	20-21-22-23-24-25-26-27-28-29-30	114,45	161,23
AV40BM27	30,0	40,0	10,0	78	11	30-31-32-33-34-35-36-37-38-39-40	171,42	220,70
AV40BM28	40,0	50,0	13,0	85	11	40-41-42-43-44-45-46-47-48-49-50	245,06	341,55
AV40BM29	50,0	60,0	13,0	85	11	50-51-52-53-54-55-56-57-58-59-60	308,77	383,55

PARA TUBULAÇÕES ROSCA GAS

AV40BM6B	6,0	32,0	10,0	75	8	6-9-11,20(1/8)-14,50 (1/4)-18,20 (3/8)-22,30 (1/2)-27,90 (3/4)-32	120,88	165,71
----------	-----	------	------	----	---	---	--------	--------

PARA REBITES CEGOS M3 - M4 - M5 - M6 E M7

AV40BM7B	4,8	10,6	6,0	54	5	4,80-6,40-7,20-9,60-10,65	39,39	56,20
----------	-----	------	-----	----	---	---------------------------	-------	-------

PARA CONDUÇÕES ELÉTRICAS (ANTIGA E NOVA NORMA)

AV40PG21B	PG7	PG21	13,0	70	11	6,5-8,5-10,5-12,5(PG7)-15,2(PG9)-18,6(PG11) 20,4(PG13,5)-22,5(PG16)-25,5-18,3(PG21)-30,5	133,11	188,18
AV40PG29B	PG7	PG29	13,0	81	14	6,5-9-11-12,5(PG7)-15,2(PG9)-18,6(PG11)-20,4(PG13,5) 22,5(PG16)-26-28,3(PG21)-30,5-33-35-37(PG29)	171,96	241,23
AV40BM8B	8,5	32,5	10,0	70	12	8,5-10,5-12,5-14,5-16,5-18,5-20,5-23,5-25,5 28-30,5-32,5	100,91	146,22
AV40BM9B	8,5	40,5	12,0	84	16	8,5-10,5-12,5-14,5-16,5-18,5-20,5-23,5-25,5 28-30,5-32,5-34,5-36,5-38,5-40,5	143,69	216,55

BROCAS ESCALONADAS DE CANAIS RETOS HSSCO

HSSCo **INOX** Ref. AVC40

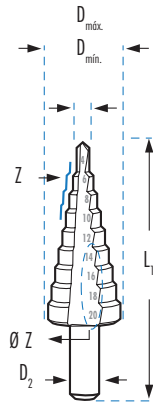

BM1 BM2 BM3 BM4 BM18

AVC40

	D mín. mm	D máx. mm	D2 mm	L1 mm	Z	Ø Z mm menor-maior	HSSCo €	TiN €
AVC40BM1B	4,0	12,0	6,0	65	5	4-6-8-10-12	50,08	76,78
AVC40BM2B	4,0	12,0	6,0	65	9	4-5-6-7-8-9-10-11-12	52,88	92,74
AVC40BM3B	4,0	20,0	8,0	69	9	4-6-8-10-12-14-16-18-20	64,94	105,07
AVC40BM4B	4,0	30,0	10,0	96	14	4-6-8-10-12-14-16-18-20-22-24-26-28-30	100,59	164,70
AVC40BM18B	6,0	37,0	10,0	100	12	6-9-12,5-15,2-18,6-20,4-22,5-26-28,3-30,5-34-37	205,94	309,27

BROCAS ESCALONADAS DE CANAIS RETOS HSS SDS-PLUS

NEW **HSS** **SDS Plus** Ref. AV40BMSDS

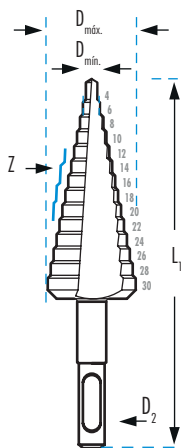

BMSDS1 BMSDS2 BMSDS3 BMSDS4

AV40BMSDS

	D mín. mm	D máx. mm	D2 mm	L1 mm	Z	Ø Z mm menor-maior	HSS €	TiN €
AV40BMSDS1B	4,0	12,0	8,8	95,5	5	4-6-8-10-12	43,16	68,11
AV40BMSDS2B	4,0	12,0	8,8	95,5	9	4-5-6-7-8-9-10-11-12	44,27	68,50
AV40BMSDS3B	4,0	20,0	8,8	104,0	9	4-6-8-10-12-14-16-18-20	56,76	87,43
AV40BMSDS4B	4,0	30,0	8,8	126,0	14	4-6-8-10-12-14-16-18-20-22-24-26-28-30	93,11	141,93

BROCAS ESCALONADAS DE CANAIS HELICOIDAIS HSS
HSS

Ref. AV42

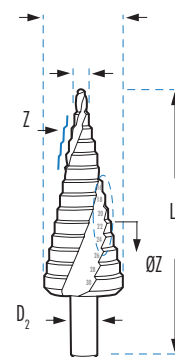
BM2
BM3
BM4

AV42

	D mín. mm	D máx. mm	D2 mm	L1 mm	Z	Ø Z mm menor-maior	HSS	TiN
							€	€
AV42BM1B	4,0	12,0	6,0	65	5	4-6-8-10-12	45,71	65,46
AV42BM2B	4,0	12,0	6,0	68	9	4-5-6-7-8-9-10-11-12	46,17	68,17
AV42BM3B	4,0	20,0	8,0	69	9	4-6-8-10-12-14-16-18-20	61,59	95,30
AV42BM4B	4,0	30,0	10,0	96	14	4-6-8-10-12-14-16-18-20-22-24-26-28-30	101,51	151,72
AV42BM5B	6,0	38,0	10,0	96	12	6-9-13-16-19-21-23-26-29-32-35-38	218,71	285,25
AV42BM11B	6,0	25,0	10,0	65	7	6-9-12-16-20-22,50-25	85,98	119,36
AV42BM12B	6,0	32,0	10,0	75	9	6-9-12-16-20-22,5-25-28,5-32	124,60	159,36
AV42BM13	6,0	40,0	13,0	105	16	6-11-17-23-29-30-31-32-33-34-35-36-37-38-39-40	288,78	326,36
AV42BM8B	8,5	32,5	10,0	70	12	8,5-10,5-12,5-14,5-16,5-18,5-20,5-23,5 25,5-28-30,5-32,5	113,18	155,25
AV42BM9B	8,5	40,5	12,0	84	16	8,5-10,5-12,5-14,5-16,5-18,5-20,5-23,5 25,5-28-30,5-32,5-34,5-36,5-38,5-40,5	177,98	231,55

BROCAS ESCALONADAS DE CANAIS HELICOIDAIS HSS MEGAESCALONADA
NEW
HSS

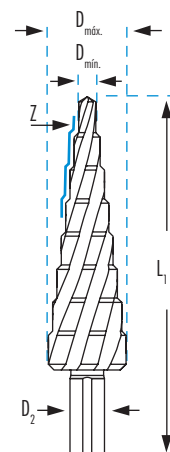
Ref. AV42BM7



AV42BM702B
AV42BM703B
AV42BM704B

AV42

	D mín. mm	D máx. mm	D2 mm	L1 mm	Z	Ø Z mm menor-maior	HSS	TiN
							€	€
AV42BM702B	6,0	12,0	6,0	105	7	6-7-8-9-10-11-12	45,95	51,05
AV42BM703B	6,0	20,0	10,0	120	8	6-8-10-12-14-16-18-20	72,11	80,12
AV42BM704B	6,0	27,0	12,0	125	8	6-9-12-15-18-21-24-27	94,88	105,42

BROCAS ESCALONADAS HSS

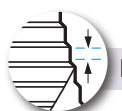
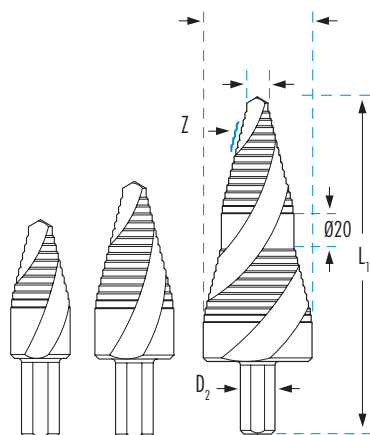

STEP CUT



ESCALON 2 mm



AV40BM37

AV40BM38

AV40BM36

	D mín. mm	D máx. mm	D ₂ mm	L1 mm	Z	Ø Z mm menor-maior	AV40BM	
							HSS €	TiN €
AV40BM37B	6,0	15,0	9,5	55	11	6-7-8-9-10-11-12-13-14-14,5-15	27,75	36,42
AV40BM38B	6,0	20,0	9,5	65	16	6-7-8-9-10-11-12-13-14-15-16-17-18-19-19,5-20	41,49	57,02
AV40BM36B	6,0	30,0	9,5	93	27	6-7-8-9-10-11-12-13-14-15-16-17-18-19-19,5-20-21-22-23-24-25-26-27-28-29-29,5-30	102,31	147,33

CABO SEXTAVADO 1/4"

	D mín. mm	D máx. mm		L1 mm	Z	Ø Z mm menor-maior	AV41	
							HSS €	TiN €
AV41BM2B	4,0	12,0	1/4"	72	9	4-5-6-7-8-9-10-11-12	46,17	68,17
AV41BM3B	4,0	20,0	1/4"	81	9	4-6-8-10-12-14-16-18-20	61,59	95,30
AV41BM4B	4,0	30,0	1/4"	105	14	4-6-8-10-12-14-16-18-20-22-24-26-28-30	101,51	151,72



Ref. AV41BM2B

SERIE CURTA Máximo 2 mm de espessura

	D mín. mm	D máx. mm	D ₂ mm	L1 mm	Z	Ø Z mm menor-maior	AV41C	
							HSS €	TiN €
AV41CBM2B	4,0	12,0	6,0	48	9	4-5-6-7-8-9-10-11-12	50,94	68,37
AV41CBM3B	4,0	20,0	8,0	58	9	4-6-8-10-12-14-16-18-20	63,24	88,36
AV41CBM4B	4,0	30,0	10,0	72	14	4-6-8-10-12-14-16-18-20-22-24-26-28-30	103,10	158,74



Ref. AV41CBM3B

BROCAS ESCALONADAS PARA CHAPA HSS CARACTERÍSTICAS ESPECIAIS
HSS

Escareadores

Rosa

APARAFUSAMENTOS MÉTRICOS DE CABO

	DIN	D mín. mm	D máx. mm	D2 mm	L1 mm	Z	Ø Z mm menor-maior	AV45	
								HSS €	TiN €
AV45BM0B	60423	5,3	30,5	10,0	79	9	5,3-7-9-10,5-14,5-18,5-23,5-27-30,5	180,94	233,33
AV45BM2B	60423	5,3	38,5	10,0	96	11	5,3-7-9-10,5-14,5-18,5-23,5-27-30,5-34,5-38,5	217,59	274,91



Ref. AV45BM2B

ESCALONADA RETA COM 3 CANAIS

	D mín. mm	D máx. mm	D2 mm	L1 mm	Z	Ø Z mm menor-maior	AV43	
							HSS €	TiN €
AV43BM1B	4,0	12,0	6,0	65	9	4-5-6-7-8-9-10-11-12	47,58	75,36
AV43BM2B	4,0	20,0	8,0	75	9	4-6-8-10-12-14-16-18-20	65,23	101,07
AV43BM3B	4,0	30,0	10,0	100	14	4-6-8-10-12-14-16-18-20-22-24-26-28-30	100,54	164,44



Ref. AV43BM3B

BROCA ESCALONADA COM BROCA GUIA INTERCAMBIÁVEL

	D mín. mm	D máx. mm	D2 mm	L1 mm	Z	Ø Z mm menor-maior	AV4	
							HSS €	
AV4BM3040	30,0	40,0	13,0	76	11	30-31-32-33-34-35-36-37-38-39-40	165,83	
AV4BM4050	40,0	50,0	13,0	76	11	40-41-42-43-44-45-46-47-48-49-50	239,52	
AV4BM5060	50,0	60,0	13,0	76	11	50-51-52-53-54-55-56-57-58-59-60	304,05	



Ref. AV4BM3040

BROCA GUIA



		BAV4BM
DESCRIÇÃO		€
BAV4BM	10X35mm	10,73

BROCAS-ESCAREADORAS E ESCALONADAS PARA TUBO, CHAPA HSS E HSSCO

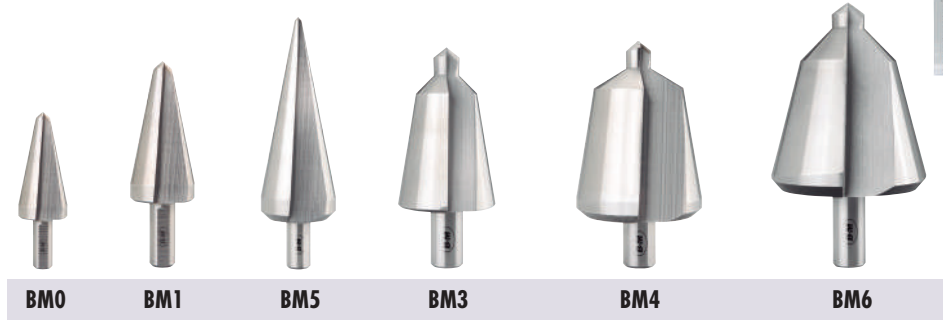
HSS **HSSCo** Ref. AV30 Ref. AVC30  

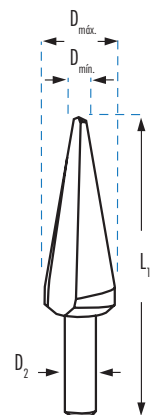

D mín. mm	D máx. mm	D ₂ mm	L ₁ mm		AV30		AVC30		
					HSS €	TiN €	HSSCo €	TiN €	
3,0	14,0	6,0	58	AV30BM0B	20,13	40,23	AVC30BM0B	37,26	48,67
3,0	22,5	8,0	85	AV30BM8B	55,65	100,85			
3,0	31,0	10,0	102	AV30BM5B	88,99	133,36			
5,0	25,4	10,0	87	AV30BM9B	63,28	120,89			
6,0	20,0	8,0	63	AV30BM1B	28,40	58,71	AVC30BM1B	49,40	75,03
16,0	30,0	10,0	79	AV30BM2B	54,93	97,15	AVC30BM2B	81,51	108,68
26,0	40,0	13,0	86	AV30BM3B	113,65	177,97	AVC30BM3B	164,73	228,88
36,0	50,0	13,0	89	AV30BM4	167,40	258,22			
40,0	61,0	13,0	98	AV30BM6	277,32	431,87			



* As referências terminadas em B, fornecem-se em blister.

BROCAS-ESCAREADORAS PARA CHAPA HSS CARACTERÍSTICAS ESPECIAIS

HSS Ref. AG Broca escareadora para cortar tubos e chapas de aço, ligas leves e materiais plásticos. Indicado até 5 mm de profundidade.

HSS Ref. AV31

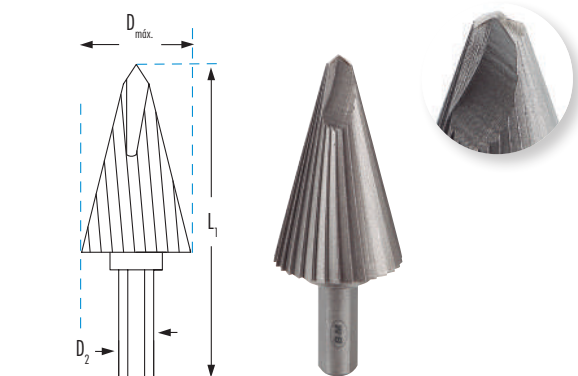

FRESA PARA TUBO E CHAPA

	D máx. mm	D ₂ mm	L ₁ mm	Nº dentes	AG
					HSS €
AG2500	25,0	8,0	72	20	28,42
AG3200	32,0	10,0	81	30	42,67
AG4500	45,0	10,0	94	36	70,48

TOPE DE PROFUNDIDADE

	D mín. mm	D máx. mm	D ₂ mm	L ₁ mm	AV31	
					HSS €	TiN €
AV31BM0B	3,0	7,8	6,0	48	32,26	48,82
AV31BM1B	3,0	10,2	6,0	52	42,36	66,41
AV31BM2B	3,0	11,8	6,0	56	47,14	83,31

**ESCAREADORES DE 3/5
CANAIS ÚLTIMA GERAÇÃO**

NEW

DIN
335C

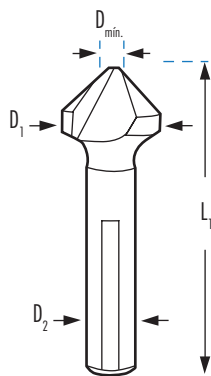
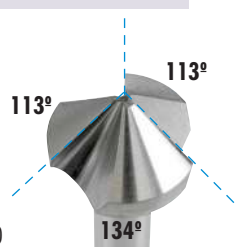

				AV66	AV67	AV99	AV55	AV6MD	AV66MD	AV55MD
MATERIAL				HSSCo	HSSCo	HSSCo	HSSCo	MD	MD	MD
ACABAMENTO					TiAlN	TiAlN				
APLICAÇÃO						INOX <i>Superflocos</i>	HARDOX 500	ALTA PRODUÇÃO		HARDOX 500
				3Z	3Z	3Z	5Z	3Z	3Z	5Z
D1 mm	D mín. mm	D2 mm	L1 mm	€	€	€	€	€	€	€
4,30	1,3	4,0	40					67,74		
5,30	1,5	4,0	40					65,22		
6,00	1,5	5,0	45					67,39		
6,30	1,5	5,0	45	22,46	29,19	41,70	4Z 29,19	72,86	81,35	4Z 101,69
8,00	2,0	6,0	50			54,96		77,62		
8,30	2,0	6,0	50	24,19	31,44	56,25	4Z 31,44	82,78	92,43	4Z 115,53
10,00	2,5	6,0	50			60,36		85,56		
10,40	2,5	6,0	50	29,11	37,85	63,85	4Z 37,85	90,29	100,81	4Z 126,01
11,50	2,8	8,0	56			68,55				
12,40	2,8	8,0	56	31,10	40,43	69,41	40,43	94,15	105,12	131,40
14,40	2,4	8,0	56	37,36	48,57					
15,00	3,2	10,0	60	43,21	56,18	85,86		98,06		
16,50	3,2	10,0	60	43,65	56,74	96,83	56,74	103,11	115,13	143,91
19,00	3,5	10,0	63			109,80				
20,50	3,5	10,0	63	57,73	75,05	119,75	75,05	142,97	159,63	199,54
23,00	3,8	10,0	67			130,15				
25,00	3,8	10,0	67	79,28	103,06	140,91	103,06	233,30	260,48	325,59
31,00	4,2	12,0	71	110,16	143,21	170,32	143,21	263,25	293,92	367,40
40,00	6,5	13,0	80	231,79	301,32	324,82		457,06*		
50,00	5,0	16,0	125	355,36	461,97					

* Cabo de 16 mm



Escareadores de corte variável antivibração.

Os escareadores de Nova Geração melhoram a qualidade do acabamento em funcionamento e prolongam a sua vida útil.

A ligeira assimetria nos cortes escareados aumenta o desempenho e reduz significativamente as vibrações durante a operação.

A disposição dos cortes no escareador contribui para uma operação de corte progressiva, aumenta o desempenho da ferramenta, melhorando o acabamento final, minimizando as irregularidades.

Os três planos de acionamento evitam escorregões, garantindo uma fixação firme do escareador ao mandril, evitando possíveis derrapagens e deslizamentos durante a utilização.

**HARDOX
500**

Escareamento HARDOX500 e materiais extremamente duros. Para escareadores em materiais de elevada dureza e HARDOX500, são recomendados os escareadores 5Z AV55 e AV55MD.

Modo de ação: É muito importante neste tipo de materiais, antes de começar a rodar o escareador para iniciar o corte, que o escareador já esteja em contacto com o material quando começa a rodar e aumentar gradualmente a velocidade à medida que começa a rodar. penetrar no material, evitando assim qualquer choque inicial, onde existe uma grande possibilidade de embotamento da aresta de corte ao aproximar-se da ferramenta.

ESCAREADORES HSS CABO CILÍNDRICO 60°, 75° E 120°

3Z

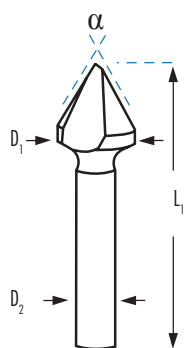

				AV8		AV9		AV10	
MATERIAL				HSS		HSS		HSS	
NORMA				DIN 334C		NORMA CELESA		NORMA CELESA	
ÂNGULO DA PONTA				60°		75°		120°	
D1 mm	D mín mm	D2 mm	L1 mm	€		€		€	
6,30	1,5	5,0	45	AV80630	20,66	AV90630	15,90	AV100630	16,93
8,00	2,0	6,0	50	AV80800	22,71				
8,30	2,0	6,0	50			AV90830	21,68	AV100830	23,33
10,00	2,5	6,0	50	AV81000	24,77				
10,40	2,5	6,0	50			AV91040	25,62	AV101040	27,26
12,40	2,8	8,0	56	AV81250	27,47	AV91240	28,30	AV101240	32,64
16,50	3,2	10,0	60	AV81600	35,13	AV91650	35,50	AV101650	41,30
20,50	3,5	10,0	63	AV82000	49,58	AV92050	52,26	AV102050	60,93
25,00	3,8	10,0	67	AV82500	69,20	AV92500	65,88	AV102500	76,85
40,00	6,5	13,0	67	AV84000	158,97	AV94000	143,33	AV104000	168,91

ESCAREADORES MULTI-CORTE CABO CILÍNDRICO 60°, 90° E 120°

5Z

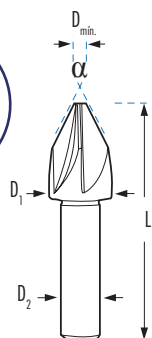

				AV12		AV11		AV13	
MATERIAL				HSS		HSS		HSS	
DIN				DIN 334A		DIN 335A		DIN 347A	
ÂNGULO DA PONTA				60°		90°		120°	
D1 mm	D mín mm	D2 mm	N° Z	L1 mm	€	L1 mm	€	L1 mm	€
8,00	2,5	8,0	5	AV120800	48 18,06	AV110800	44 13,58	AV130800	44 17,99
12,50	2,8	8,0	5	AV121250	52 25,27	AV111250	48 19,89	AV131250	48 26,42
16,00	3,0	10,0	5	AV121600	60 42,39	AV111600	56 33,39	AV131600	56 44,32
20,00	3,5	10,0	5	AV122000	64 54,68	AV112000	60 43,01	AV132000	60 57,14
25,00	3,5	10,0	5	AV122500	69 76,54	AV112500	65 60,21	AV132500*	65 77,73

* D2: 12,00 mm

ESCAREADORES HSS E HSSCO PARA REBARBAR COM FURO

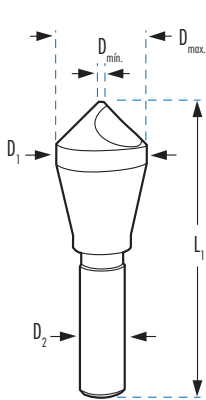

MATERIAL					AV1		AV1T		AV2		AV2T		AV1-60	
ACABAMENTO					HSS		HSS		HSSCo		HSSCo		HSS	
ÂNGULO DA PONTA					90°		TiN 90°		90°		TiN 90°		60°	
D1 mm	Dmin mm	Dmax mm	D2 mm	L1 mm	€	€	€	€	€	€	€	€	€	
6,35	2,0	5,0	6,35	45	AV100	14,74	AV100T	26,63	AV200	25,05	AV200T	42,14	AV100-60	26,40
10,00	2,0	5,0	6,00	45	AV101	18,17	AV101T	27,85	AV201	25,87	AV201T	42,14	AV101-60	32,98
14,00	6,0	13,0	8,00	50	AV102	22,70	AV102T	39,15	AV202	30,13	AV202T	52,54	AV102-60	40,04
20,00	8,0	18,0	10,00	65	AV103	40,64	AV103T	70,00	AV203	53,86	AV203T	88,93	AV103-60	45,67
27,00	11,0	25,0	12,00	85	AV104	72,64	AV104T	115,07	AV204	87,76	AV204T	140,10	AV104-60	79,57
30,00	12,0	28,0	15,00	95	AV105	122,59	AV105T	218,37	AV205	139,43	AV205T	240,73	AV105-60	130,40
35,00	14,0	33,0	15,00	100	AV106	188,28	AV106T	299,01	AV206	233,61	AV206T	404,84	AV106-60	206,65
40,00	16,0	38,0	15,00	110	AV107	259,96	AV107T	424,96	AV207	268,79	AV207T	433,74	AV107-60	280,07
45,00	18,0	42,0	15,00	120	AV108	344,44	AV108T	516,12	AV208	403,95	AV208T	575,41	AV108-60	361,96
50,00	20,0	48,0	15,00	130	AV109	415,59	AV109T	600,06	AV209	538,38	AV209T	722,42	AV109-60	441,04

ESCAREADORES CÔNICOS 90° MULTI-NAVALHA

Ref. FC

TiAIN

MD

FC							€
D1 mm	D2 mm	L mm	L2 mm	D3 mm	Z		€
0,5	0,1	39,0	3,0	3,0	3	FC0050	65,87
0,6	0,1	39,0	3,0	3,0	3	FC0060	65,87
0,7	0,1	39,0	3,0	3,0	3	FC0070	65,87
0,8	0,1	39,0	3,0	3,0	3	FC0080	65,87
0,9	0,1	39,0	3,0	3,0	3	FC0090	65,87
1,0	0,1	39,0	3,0	3,0	3	FC0100	63,59
1,5	0,1	39,0	4,5	3,0	3	FC0150	63,59
2,0	0,1	39,0	6,0	3,0	3	FC0200	63,59
2,5	0,1	39,0	7,5	3,0	3	FC0250	63,59
3,0	0,1	39,0	-	3,0	3	FC0300	63,59
4,0	0,8	54,0	-	4,0	4	FC0400	65,87
6,0	0,8	57,0	-	6,0*	4	FC0600	69,27
8,0	0,8	63,0	-	8,0*	5	FC0800	76,09
10,00	1,0	72,0	-	10,0*	6	FC1000	90,85
12,00	1,2	83,0	-	12,0*	6	FC1200	134,00
16,00	1,6	92,0	-	16,0*	6	FC1600	239,61
20,00	2,0	104,0	-	20,0*	6	FC2000	438,33

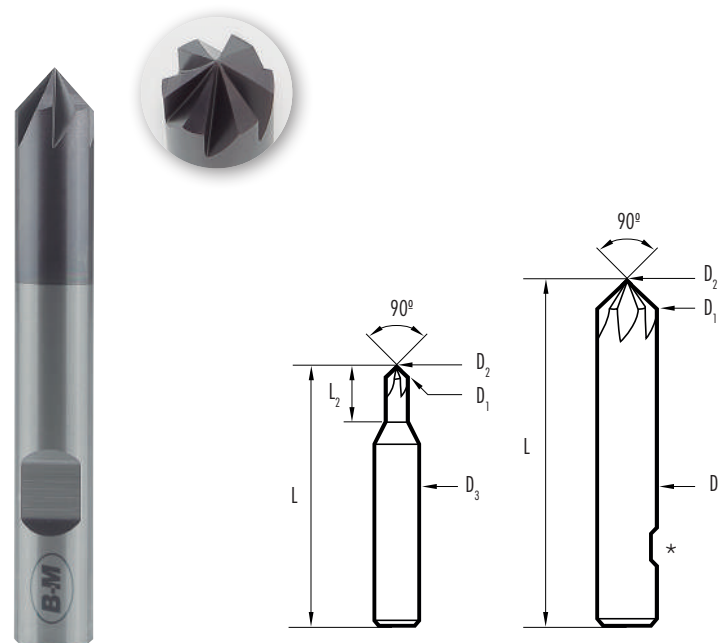

*Com plano de arrasto

ESCAREADORES COM CABO CÔNICO

3Z

Ref. AV17

DIN 335D

HSS



90°

Ref. AV17MD

DIN 335D

MD



90°

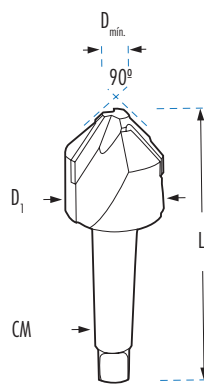
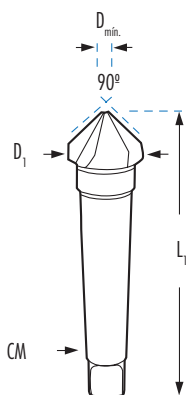

AV17

AV17MD

D1 mm	D min. mm	L1 mm	CM	€
16,50	4,0	90	1	86,57
20,50	3,5	100	2	102,06
25,00	3,8	106	2	103,11
31,00	4,2	112	2	114,77
40,00	10,0	140	3	176,62
50,00	14,0	150	3	222,34
63,00	16,0	180	4	359,49
80,00	22,0	190	4	615,10
100,00	25,0	210	4	1.585,27

D1 mm	D min. mm	L1 mm	CM	€
63,00	16,0	190	4	1.504,61*
80,00	22,0	190	4	1.836,84*

*Até o fim das existências.

ESCAREADORES MULTI-CORTE COM CABO CÔNICO

MULTI CORTE

Ref. AV23

DIN 334B



60°

Ref. AV18

DIN 335B



90°

Ref. AV24

DIN 347B



120°

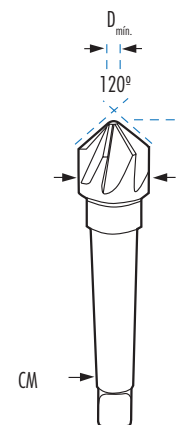
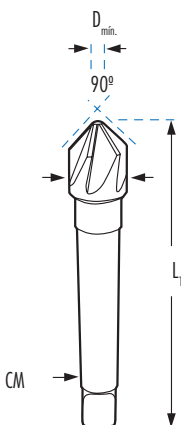
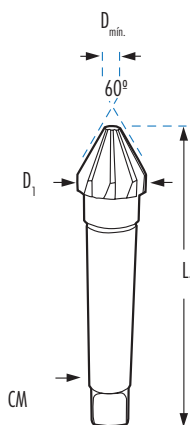

AV23

AV18

AV24

D1 mm	D min. mm	L1 mm	CM	Z	HSS	€
16,00	3,2	93	1	7	HSS	65,68
20,00	4,0	116	2	7	HSS	76,89
25,00	7,0	121	2	9	HSS	84,22
31,50	9,0	124	2	9	HSS	115,16
40,00	12,5	150	3	11	HSS	210,77
50,00	16,0	153	3	13	HSS	251,95
63,00	20,0	185	4	15	HSS	385,70
80,00	25,0	196	4	17	HSS	596,10

D1 mm	D min. mm	L1 mm	CM	Z	HSS	€
16,00	3,2	93	1	7	HSS	66,99
20,00	4,0	116	2	7	HSS	78,34
25,00	7,0	121	2	9	HSS	85,91
31,50	9,0	124	2	9	HSS	117,50
40,00	12,5	150	3	11	HSS	215,03
50,00	16,0	153	3	13	HSS	256,92
63,00	20,0	185	4	15	HSS	368,86
80,00	25,0	196	4	17	HSS	608,07
100,00	22,0	190	4	20	HSS	1.639,13

D1 mm	D min. mm	L1 mm	CM	Z	HSS	€
16,00	3,2	93	1	7	HSS	68,22
20,00	4,0	116	2	7	HSS	79,84
25,00	7,0	121	2	9	HSS	91,69
31,50	9,0	124	2	9	HSS	119,61
40,00	12,5	150	3	11	HSS	190,46
50,00	16,0	153	3	13	HSS	246,01
63,00	20,0	185	4	15	HSS	400,53
80,00	25,0	196	4	17	HSS	619,03
100,00	27,0	210	4	3	HSS	1.624,65

ESCAREADORES DE 1 CANAL

HSS

CABO CILÍNDRICO
Ref. AV27
Ref. AV29



HSS

CABO CÓNICO
Ref. AV34
Ref. AV28

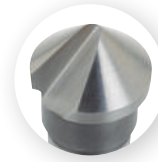
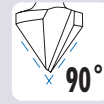

1Z

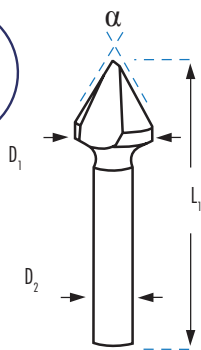

1Z

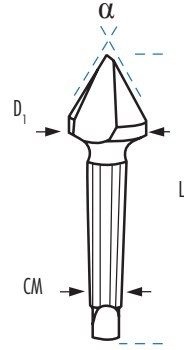

AV27

AV29

	D1 mm	D2 mm	L1 mm	90° €	60° €
AV270600	6,0	5,0	45	14,18	AV290600 26,16
AV270800	8,0	6,0	46	14,98	AV290800 27,40
AV271000	10,0	8,0	46	15,87	AV291000 28,69
AV271200	12,0	8,0	46	18,48	AV291200 32,23
AV271600	16,0	8,0	46,5	22,01	AV291600 39,24
AV272000	20,0	10,0	47	30,08	AV292000 50,44
AV272500	25,0	10,0	51	39,62	AV292500 79,42
AV273000	30,0	12,0	71	57,15	AV293000 103,72
AV274000	40,0	13,0	89	148,93	AV294000 180,29
AV275000	50,0	13,0	98	183,87	AV295000 269,35

AV34

AV28

	D1 mm	CM	L1 mm	90° €	60° €
AV341600	16,0	1	92	68,19	AV281600 65,24
AV342000	20,0	2	107	85,46	AV282000 71,47
AV342500	25,0	2	110	110,05	AV282500 105,97
AV343000	30,0	2	114	125,05	AV283000 139,64
AV344000	40,0	3	145	201,21	AV284000 183,86
AV345000	50,0	3	152	293,81	AV285000 279,21

ESCREADORES EXTERNOS DE 3 CANAIS
3Z

Ref. AVX

HSS

90°

Ref. AVX-60

HSS

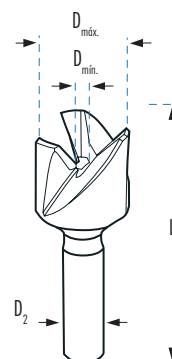
60°

AVX					
Dmáx. mm	Dmín. mm	D2 mm	L1 mm		€
12,00	4,0	8,0	55	AVX1	59,35
20,00	8,0	10,0	60	AVX2	110,56
28,00	10,0	13,0	70	AVX3	156,84
40,00	12,0	CM2	125	AVX4	238,00
50,00	15,0	CM3	130	AVX5	332,51

AVX-60					
Dmáx. mm	Dmín. mm	D2 mm	L1 mm		€
8,00	3,0	8,0	55	AVX1-60	63,40
15,00	6,0	10,0	60	AVX2-60	121,66
28,00	10,0	13,0	75	AVX3-60	182,33

ESCREADOR EXTERNO PARA REPARAÇÃO DE FIOS DE ENTRADA

Ref. AVEXT

HSS

60°

Min.-Max.		L1 mm		€
M8-M18	1/4"	75	AVEXT	28,11

ESCREADOR EXTERNO PARA REPARAÇÃO DE FIOS DE ENTRADA DE METAL DURO
NEW

Ref. AVMDEXT

MD

60°
INOX

Min.-Max.			€
5-25 mm	1/4"	AVMDEXT	32,36

ESCAREADORES PARA PARAFUSOS «ALLEN»

CABO CILÍNDRICO

Ref. AV2

**DIN
373**

HSS

NOTA: a longitude de corte entende-se sem a guia.

* O ajustamento grosso usa-se para escarear furos roscados.

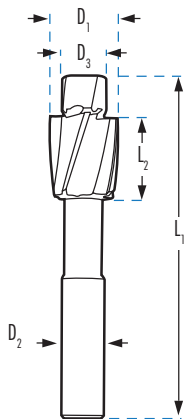

Para escarear furos roscados



AV2M

AV2MM

AV2GM

AJUSTAMENTO						FINO		MEIO		FURO ROSCADO			
	D1 mm	D2 mm	L1 mm	L2 mm		D3 mm	€	D3 mm	€	D3 mm	€		
M3	6,0	5,0	71	14	AV2M3	3,2	25,59	AV2MM3	3,4	27,70	AV2GM3	2,5	27,70
M4	8,0	5,0	71	14	AV2M4	4,3	25,59	AV2MM4	4,5	27,70	AV2GM4	3,3	27,70
M5	10,0	8,0	80	18	AV2M5	5,3	25,59	AV2MM5	5,5	27,70	AV2GM5	4,2	27,70
M6	11,0	8,0	80	18	AV2M6	6,4	28,84	AV2MM6	6,6	31,22	AV2GM6	5,0	31,22
M7	20,0	12,7	90	20	AV2M7	7,4	53,25						
M8	15,0	12,5	100	22	AV2M8	8,4	35,75	AV2MM8	9,0	38,70	AV2GM8	6,8	38,70
M10	18,0	12,5	100	22	AV2M10	10,5	42,56	AV2MM10	11,0	46,07	AV2GM10	8,5	46,07
M11	22,0	18,8	100	22	AV2M11	11,5	56,65						
M12	20,0	12,5	100	22	AV2M12	13,0	49,65	AV2MM12	14,0	53,75	AV2GM12	10,2	53,75
M14	24,0	12,5	100	22	AV2M14	15,0	77,66	AV2MM14	15,5	84,07	AV2GM14	12,0	84,07
M16	26,0	12,5	100	22	AV2M16	17,0	85,42	AV2MM16	17,5	92,46	AV2GM16	14,0	92,46

CABEÇA CÓNICA COM GUIA

Ref. AV3

**DIN
1866**

HSS

NOTA: A longitude de corte entende-se sem a guia.

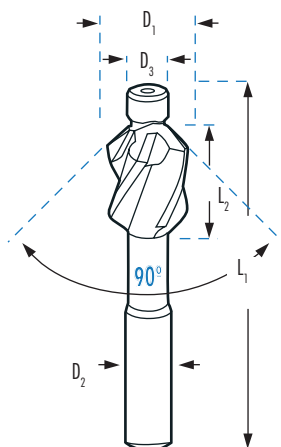

AJUSTAMENTO						AV3	
	D1 mm	D2 mm	L1 mm	L2 mm		D3 mm	FINO
M3	6,3	6,0	71	14,0	AV3M3	3,2	35,00
M4	8,3	8,0	71	14,0	AV3M4	4,3	35,00
M5	10,4	10,0	80	18,0	AV3M5	5,3	35,00
M6	12,4	10,0	80	18,0	AV3M6	6,4	39,77
M8	16,5	12,0	100	22,0	AV3M8	8,4	48,67
M10	20,5	12,0	100	22,0	AV3M10	10,5	52,65
M12	24,5	13,0	110	25,0	AV3M12	13,0	64,18

ESCAREADORES PARA PARAFUSOS «ALLEN»

CABO CÓNICO

DIN
375
HSS

Ref. AV5

NOTA: A longitude de corte entende-se sem a guia.

* O ajustamento grosso usa-se para escarear furos roscados.

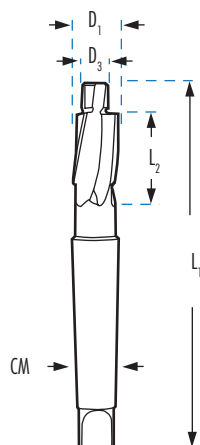
PARA ESCAREAR
FUROS ROSCADOS



AJUSTAMENTO					AV5M			AV5MM			AV5GM		
D1 mm	CM	L1 mm	L2 mm		D3 mm	FINO	D3 mm	MEIO	D3 mm	FURO ROSCADO	D3 mm	€	
						€		€		€			
M8	15,0	2	132	22	AV5M8	8,4	69,29		AV5GM8	6,8	69,29		
M10	18,0	2	140	25	AV5M10	10,5	71,11	AV5MM10	11,0	71,11	AV5GM10	8,5	71,11
M12	20,0	2	140	25	AV5M12	13,0	78,68	AV5MM12	14,0	78,68	AV5GM12	10,2	78,68
M14	24,0	2	150	30	AV5M14	15,0	109,21	AV5MM14	15,5	109,21	AV5GM14	12,0	109,21
M16	26,0	3	180	35	AV5M16	17,0	128,25	AV5MM16	17,5	128,25	AV5GM16	14,0	128,25
M18	30,0	3	180	35	AV5M18	19,0	138,38	AV5MM18	20,0	138,38	AV5GM18	15,5	138,38
M20	33,0	3	190	40	AV5M20	21,0	150,77	AV5MM20	22,0	150,77	AV5GM20	17,5	150,77
M22	36,0	3	190	40	AV5M22	23,0	183,73	AV5MM22	24,0	183,73	AV5GM22	19,5	183,73
M24	40,0	3	190	40	AV5M24	25,0	222,11	AV5MM24	26,0	222,11	AV5GM24	21,0	222,11
M27	46,0	4	255	50	AV5M27	30,0	252,38						
M30	48,0	4	255	50	AV5M30	33,0	305,32						

APLICAÇÕES DOS TIPOS DE AJUSTAMENTOS: FINO, MEIO E FURO ROSCADO

 T1: Parafusos cabeça cilíndrica DIN 84 e DIN 7984
 Parafusos Auto-roscentes DIN 7513

T2 : Parafusos cabeça cilíndrica DIN 6912

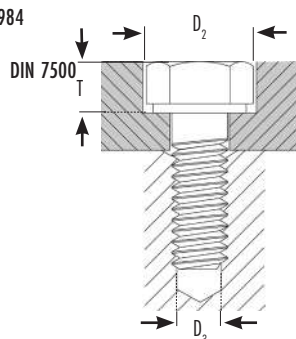
T3 : Parafusos cabeça cilíndrica DIN 912



	FINO	MEIO	FURO ROSCADO				
ROSCAS MÉTRICAS	D3 mm	D3 mm	D3 mm	D2 mm	T1 mm	T2 mm	T3 mm
M3	3,2	3,4	2,5	6,0	2,4	--	3,4
M4	4,3	4,5	3,3	8,0	3,2	3,4	4,6
M5	5,3	5,5	4,2	10,0	4,0	4,2	5,7
M6	6,4	6,6	5,0	11,0	4,7	4,8	6,8
M8	8,4	9,0	6,8	15,0	6,0	6,0	6,0
M10	10,5	11,0	8,5	18,0	7,0	7,5	11,0
M12	13,0	13,5	10,2	20,0	8,0	8,5	13,0
M14	15,0	15,5	12,0	24,0	9,0	9,5	15,0
M16	17,0	17,5	14,0	26,0	10,5	11,5	17,5
M18	19,0	20,0	15,5	30,0	11,5	12,5	19,5
M20	21,0	22,0	17,5	33,0	12,5	13,5	21,5
M22	23,0	24,0	19,5	36,0	13,5	14,5	23,5

ESCAREADORES COM ELEMENTOS INTERCAMBIÁVEIS PARA PARAFUSOS COM CABEÇA "ALLEN" E CÔNICA

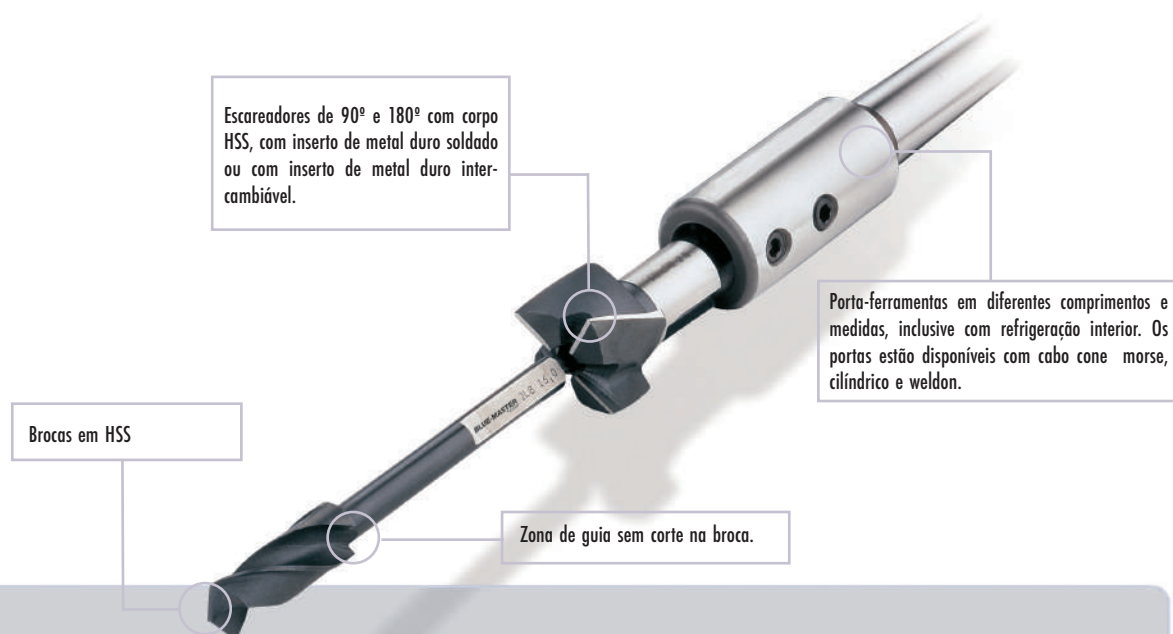

O SISTEMA BLUE-MASTER

O sistema BLUE-MASTER é único para operações de escareado, e ajuda a incrementar a produtividade e diminuir os custos.

Os nossos porta-ferramentas, fresas, brocas e guias podem combinar-se para adaptar-lhos a todos os tipos de máquinas e aplicações.

Você pode compor facilmente mais de 1.500.000 ferramentas especiais com só 1.300 peças.

O sistema consta de 3 grupos de dimensões: SERIE A, SERIE B e SERIE C.

Todas as combinações têm que fazer-se com elementos do mesmo grupo. Ferramentas de diferentes grupos não são combináveis entre si.

Nas seguintes páginas encontrará tanto as faixas de medidas disponíveis em cada grupo, como as recomendações para a correta escolha tanto da ferramenta como dos dados de corte.

Importante!

- * Com corte de metal duro colocar o parafuso de ajuste axial em contato com a guia da broca insertada.
- * Deixar um espaço entre o fio e a guia da broca para prevenir quebras por impacto accidental.
- * O parafuso axial também se usa para prolongar a vida das brocas depois de reafiar-lhas.

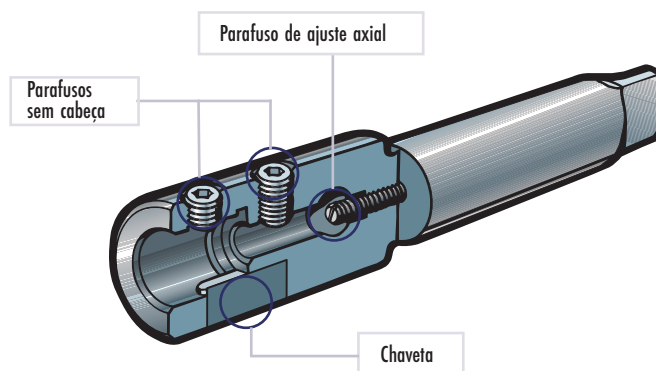

DIMENSÕES DE GUIA, PORTA E BROCA

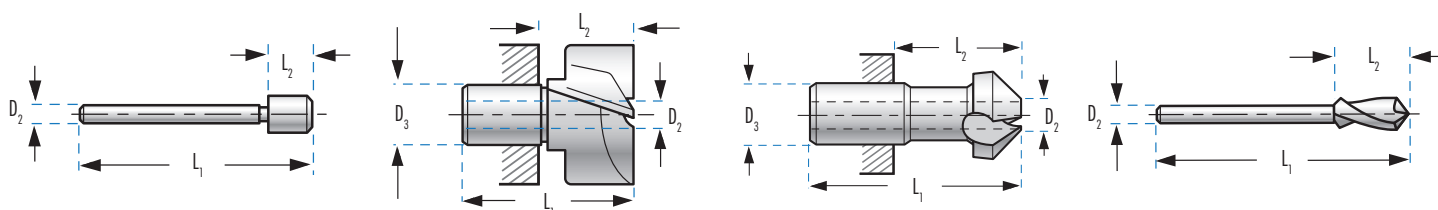

	GUIA				PORTA					ESCAREADOR					BROCA			
	D2 mm	L1 mm	L2 mm		D3 mm	D2 mm	L1 mm	L2 mm		D3 mm	D2 mm	L1 mm	L2 mm		D2 mm	L1 mm	L2 mm	
AGP	4	64	9		APAV-MD-PQ	10	4	40	22	AVC	10	4	40	22	ABP	4	70	15
BGP	6	80	14		BPAV-MD-PQ	14	6	48	28	BVC	14	6	48	28	BBP	6	95	25
CGP	10	110	20		CPAV-MD-PQ	22	10	61	33	CVC	22	10	61	33	CBP	10	125	30

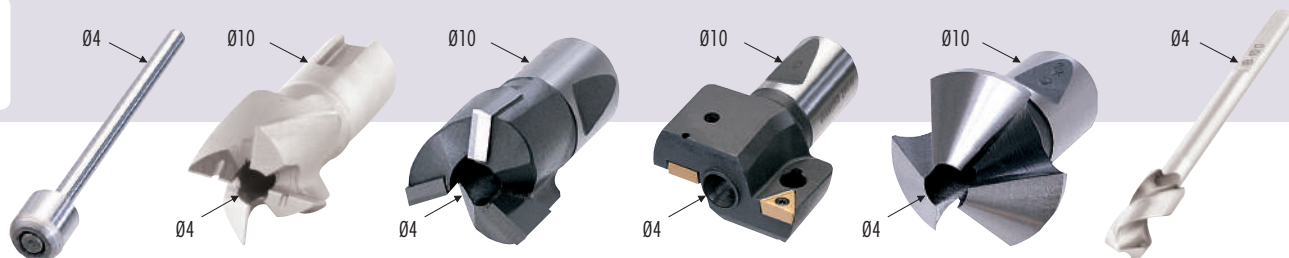
**ESCAREADORES COM ELEMENTOS INTERCAMBIÁVEIS
 PARA PARAFUSOS COM CABEÇA "ALLEN" E CÓNICA**
**SERIE
 A**

GUIA

PORTA

PORTA

PASTILHA INTERCAMBIÁVEL

ESCAREADOR

BROCA

AGP

APAV

APAVMD

APAVPQ

AVC

ABP

HSS

MD

PMD

HSS

HSS

€

€

€

€

€

€

AGP	APAV	APAVMD	APAVPQ	AVC	ABP
€	HSS €	MD €	Pastilha não incluída PMD €	90° HSS €	HSS €
					ABP0430 80,83
					ABP0450 80,83
					ABP0500 80,83
					ABP0530 80,83
					ABP0550 80,83
				AVC0800 185,52	ABP0600 95,01
				AVC1000 185,52	ABP0640 95,01
				AVC1200 188,29	ABP0660 95,01
					ABP0700 95,01
				AVC1150 182,08	
				AVC1240 190,48	
				AVC1350 190,48	
				AVC1400 204,20	
AGP0400 46,64					
AGP0450 55,62	APAV0700 142,35				
AGP0550 55,62	APAV0800 140,63				
AGP0600 55,62	APAV0900 140,63				
AGP0650 55,62	APAV1000 136,12	APAVMD1000 399,78			
AGP0640 55,62					
AGP0660 55,62	APAV1100 140,63	APAVMD1100 399,78			
AGP0500 55,62					
	APAV1150 155,49				
	APAV1200 142,35	APAVMD1200 399,78			
	APAV1250 157,90				
	APAV1300 155,15	APAVMD1300 399,78			
	APAV1350 178,63				
	APAV1400 155,15	APAVMD1400 403,56			
	APAV1450 178,98				
AGP0840 56,33					
AGP0900 56,33	APAV1500 156,87	APAVMD1500 408,06		AVC1500 205,91	
AGP0680 55,62					
AGP0700 55,62	APAV1600 165,83	APAVMD1600 417,40		AVC1600 206,96	
AGP0750 55,62	APAV1700 168,99	APAVMD1700 426,39		AVC1650 201,45	
AGP0800 56,33	APAV1800 173,43	APAVMD1800 435,34	APAVPQ1800 909,39		
AGP0850 56,33	APAV1900 184,52	APAVMD1900 455,03			
AGP0900 56,33	APAV2000 191,08	APAVMD2000 464,73	APAVPQ2000 1.019,28		
AGP0950 56,33	APAV2100 208,36	APAVMD2100 486,81			
AGP1000 56,33					
AGP1050 56,33					
AGP1100 56,33					
AGP1150 56,33					

ADAPTADORES

	D1 mm	D2 mm	L1 mm	L2 mm	CM Ø mm	APH €
APHCM1	18	10	110	48	CM1	333,41
APHCM2	18	10	132	57	CM2	327,20
APH-10	18	10	92	42	Ø10	311,65

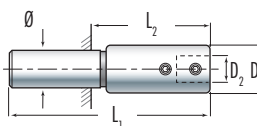
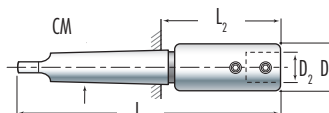
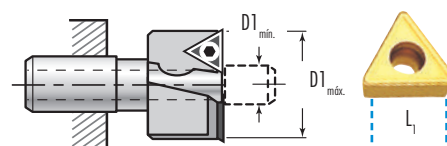
PASTILHAS DE REPOR

	L1 mm	D1 mín. Ømm	D1 máx. Ømm	PPQ €
PPQ07	7	18	20	34,56

**ESCAREADORES COM ELEMENTOS INTERCAMBIÁVEIS
PARA PARAFUSOS COM CABEÇA "ALLEN" E CÔNICA**

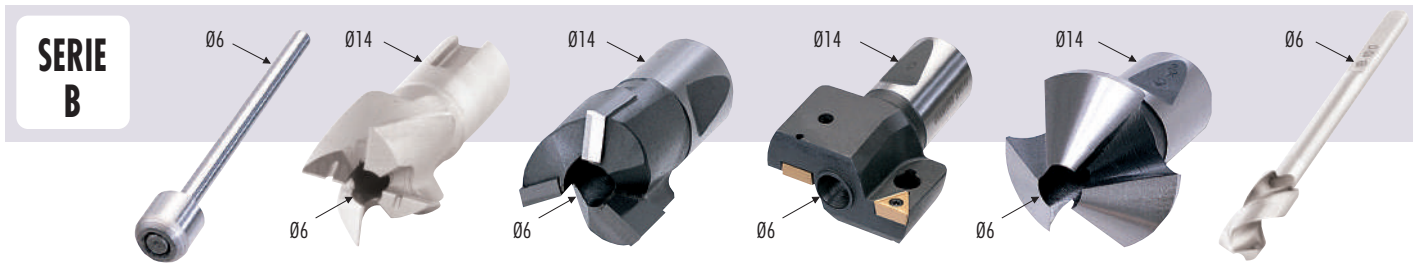

GUIA		PORTA		PORTA		PASTILHA INTERCAMBIÁVEL		ESCAREADOR		BROCA	
BGP		BPAV		BPAVMD		BPAVPQ		BVC		BBP	
€		HSS €		MD €		Pastilha não incluída €	PMD €	90° €	HSS €		HSS €
		BPAV1300	157,56	BPAVMD1300	426,39						
		BPAV1350	177,92								
		BPAV1400	157,56	BPAVMD1400	426,39						
		BPAV1450	177,92								BBP0800 112,99
BGP0840	52,52										
BGP0900	52,52	BPAV1500	157,56	BPAVMD1500	426,39			BVC15	195,57	BBP0900	112,99
BGP0680	52,52										
BGP0800	52,52										
BGP1000	52,52	BPAV1550	180,35								
BGP1150	55,62	BPAV1600	166,21	BPAVMD1600	442,25					BBP0840	112,99
BGP1250	57,00	BPAV1650	192,79							BBP0850	112,99
BGP1350	63,57	BPAV1700	173,09	BPAVMD1700	442,25					BBP0950	112,99
BGP1450	64,25	BPAV1750	194,16							BBP1000	128,87
		BPAV1900	199,71	BPAVMD1900	446,08					BBP1050	128,87
BGP1050	55,62										
BGP1100	55,62	BPAV1800	179,67	BPAVMD1800	446,08			BVC20	221,12	BBP1100	128,87
BGP0850	52,52										
BGP1300	63,57										
BGP1400	64,25	BPAV2000	199,71	BPAVMD2000	459,88	BPAVPQ2000	910,15	BVC25	230,13		
BGP1020	55,62										
BGP1500	64,25										
BGP1550	64,25	BPAV2400	236,00	BPAVMD2400	488,57	BPAVPQ2400	911,32	BVC28	267,77		
BGP1200	55,62										
BGP1700	64,25										
BGP1750	64,25	BPAV2600	252,22	BPAVMD2600	491,33	BPAVPQ2600	1.044,89	BVC30	273,66		
BGP1400	64,25										
BGP1900	65,64										
BGP2000	81,89	BPAV3000	340,67	BPAVMD3000	535,91	BPAVPQ3000	1.044,89				
		BPAV3400	402,85	BPAVMD3400	618,08	BPAVPQ3400	1.206,05				

ADAPTADORES

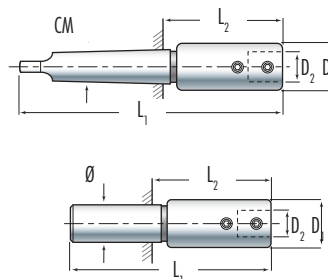

	D1 mm	D2 mm	L1 mm	L2 mm	CM Ømm	€
BPHCM1	24	14	123	62	CM1	369,72
BPHCM2	24	14	137	62	CM2	337,57
BPHCM3	24	14	160	66	CM3	369,72
BPH-12	24	14	120	55	Ø12	333,75

PASTILHAS DE REPOR

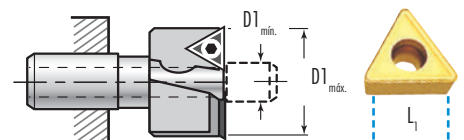

	L1 mm	D1 mín. Ømm	D1 máx. Ømm	€
PPQ07	7	20	25	34,56
PPQ10	10	26	33	31,11
PPQ12	12	34	36	31,11

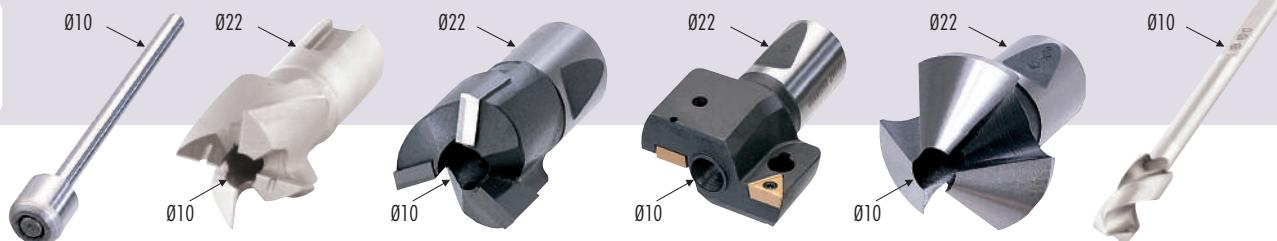
**ESCAREADORES COM ELEMENTOS INTERCAMBIÁVEIS
 PARA PARAFUSOS COM CABEÇA "ALLEN" E CÔNICA**
**SERIE
C**

GUIA

PORTA

PORTA

PASTILHA INTERCAMBIÁVEL

ESCAREADOR

BROCA

CGP

CPAV

CPAVMD

CPAVPQ

CVC

CBP

CGP	€	CPAV		CPAVMD		CPAVPQ		CVC		CBP	
		HSS	€	MD	€	Pastilha não incluída	PMD	90°	HSS	HSS	€
CGP1200	59,77	CPAV2300	286,08	CPAVMD2300	533,12						
CGP1250	59,77	CPAV2400	289,86	CPAVMD2400	527,59						
CGP1300	59,77	CPAV2500	313,40	CPAVMD2500	528,64						
CGP1350	59,77	CPAV2600	319,61	CPAVMD2600	543,15						
CGP1400	70,14	CPAV2700	324,09								
CGP1450	70,14	CPAV2800	330,31	CPAVMD2800	548,33					CBP1700	282,30
CGP1500	70,14	CPAV2900	338,25							CBP1800	318,21
CGP1600	70,14	CPAV3100	367,63							CBP1900	333,75
CGP1650	70,14	CPAV3200	379,72	CPAVMD3200	598,77					CBP2100	361,77
CGP1700	70,14	CPAV3300	383,16							CBP2300	435,34
CGP1900	70,14										
CGP2000	70,14	CPAV3000	342,73	CPAVMD3000	604,65			CVC35	399,06	CBP2000	361,77
CGP1550	70,14										
CGP2100	78,09										
CGP2200	78,09	CPAV3400	387,00	CPAVMD3400	642,66	CPAVPQ3400	1.247,19	CVC37	422,22	CBP2200	403,56
CGP1750	70,14										
CGP1850	70,14	CPAV3500	405,29								
CGP2300	78,09										
CGP2400	78,09	CPAV3600	410,14	CPAVMD3600	660,27	CPAVPQ3600	1.247,19	CVC37	422,22	CBP2400	444,70
CGP1950	70,14										
CGP2500	78,09										
CGP2600	96,04	CPAV4000	476,13	CPAVMD4000	731,44	CPAVPQ4000	1.275,92	CVC40	448,82		
CGP2100	78,09										
CGP2200	78,09	CPAV4500	587,38			CPAVPQ4500	1.299,22				
CGP2050	78,09	CPAV5000	853,08			CPAVPQ5000	1.520,17				
		CPAV5500	898,68			CPAVPQ5500	1.795,45				
		CPAV6000	947,04			CPAVPQ6000	1.795,45				
		CPAV6500	1.065,23			CPAVPQ6500	2.053,27				

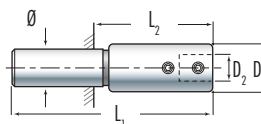
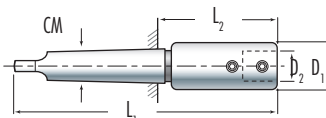
ADAPTADORES

	D1 mm	D2 mm	L1 mm	L2 mm	CM Ømm	CPH	€
CPHCM2	36	22	160	85	CM2		486,81
CPHCM3	36	22	180	87	CM3		459,88
CPHCM4	36	22	206	89	CM4		515,50
CPHCM5	36	22	240	91	CM5		1.134,34
CPH-12	36	22	140	71	Ø20		333,75

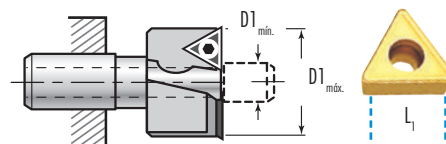
PASTILHAS DE REPOR

	L1 mm	D1 mín. Ømm	D1 máx. Ømm	PPQ	€
PPQ12	12	34	45		31,11
PPQ17	17	<46			48,20

ESTOJOS DE ESCAREADORES

ESTOJOS DE BROCAS ESCAREADORAS PARA TUBO E CHAPA HSS E HSSCO



Ref. PAV6CM2



Ref. PAV40BM2313

Metal Clássico

- Caixa metálica alta resistência.



Ref. AV40BM234

Ref. AV6CM3

Plástico Azul

- Rígido, robusto e leve.
- Janela transparente.
- Plástico reforçado com borracha anti-choque.

P Referências iniciadas por "P"
São fornecidos em uma caixa de plástico.

AV40	Ref.	Uds.	CONTEÚDO	HSS	TiN
				€	
	PAV40BM234	3	P AV40BM2 (4-12 mm) AV40BM3 (4-20 mm) AV40BM4 (4-30 mm)	192,40	290,24
	PAV40BM235	3	P AV40BM2 (4-12 mm) AV40BM3 (4-20 mm) AV40BM5 (6-38 mm)	309,18	427,57
	HSS PAV40BM2313	3	P AV40BM2 (4-12 mm) AV40BM3 (4-20 mm) AV40BM13 (6-40 mm)	386,72	475,50
	AV40BM234	3	M AV40BM2 (4-12 mm) AV40BM3 (4-20 mm) AV40BM4 (4-30 mm)	192,40	290,24
	AV40BM22122	3	M AV40BM2 (4-12 mm) AV40BM21 (7+10-20mm) AV40BM22 (10+20-30mm)	268,09	416,01
AVC40				HSSCo	TiN
HSSCo	AVC40BM234	3	M AVC40BM2 (4-12 mm) AVC40BM3 (4-20 mm) AVC40BM4 (4-30 mm)	227,65	371,75
AV42				HSSCo	TiN
HSSCo	AV42BM234	3	M AV42BM2 (4-12 mm) AV42BM3 (4-20 mm) AV42BM4 (4-30 mm)	218,50	324,43
AV30				HSS	TiN
	HSS AV30BM012	3	M AV30BM0 (3-14 mm) AV30BM1 (6-20 mm) AV30BM2 (16-30 mm)	118,93	205,33
AVC30				HSSCo	TiN
	HSSCo AVC30BM012	3	M AVC30BM0 (3-14 mm) AVC30BM1 (6-20 mm) AVC30BM2 (16-30 mm)	171,33	241,36



AV40BM2 AV40BM3 AV40BM4 AV40BM5 AV40BM13

AVC40BM2 AVC40BM3 AVC40BM4



AV42BM2 AV42BM3 AV42BM4



AV30BM0 AV30BM1 AV30BM2

AVC30BM0 AVC30BM1 AVC30BM2

ESTOJOS DE ESCAREADORES

Escareadores

Rosca



AV16	Ref.	Uds.		CONTEÚDO	€
HSS	AV16CM1	6	M	Ø 6 - 8 - 10 11,5 - 15 - 19 mm	229,08
	AV16CM2	6	M	Ø 6,3 - 8,3 - 10,4 12,4 - 16,5 - 20,5 mm	234,81
TiN	AV16CM3	7	M	Ø 6,3 - 8,3 - 10,4 12,4 - 16,5 - 20,5 - 25 mm	307,72



Ref. PAV6CM2

Ref. AV16CM3



AV6	Ref.	Uds.		CONTEÚDO	€
HSS	AV6CM1	6	M	Ø 6 - 8 - 10 11,5 - 15 - 19 mm	145,16
	AV6CM2	6	M	Ø 6,3 - 8,3 - 10,4 12,4 - 16,5 - 20,5 mm	143,06
	AV6CM3	7	M	Ø 6,3 - 8,3 - 10,4 12,4 - 16,5 - 20,5 - 25 mm	196,11
	PAV6CM2	6	P	Ø 6,3 - 8,3 - 10,4 12,4 - 16,5 - 20,5 mm	143,06



AV7	Ref.	Uds.		CONTEÚDO	€
HSSCo	AV7CM1	6	M	Ø 6 - 8 - 10 11,5 - 15 - 19 mm	173,41
	AV7CM2	6	M	Ø 6,3 - 8,3 - 10,4 12,4 - 16,5 - 20,5 mm	171,79
	AV7CM3	7	M	Ø 6,3 - 8,3 - 10,4 12,4 - 16,5 - 20,5 - 25 mm	237,12
	PAV7CM2	6	P	Ø 6,3 - 8,3 - 10,4 12,4 - 16,5 - 20,5 mm	171,79



AV66	Ref.	Uds.		CONTEÚDO	€
HSSCo	PAV66CM2	6	P	Ø 6,3 - 8,3 - 10,4 12,4 - 16,5 - 20,5 mm	208,23

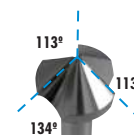

AV67	Ref.	Uds.		CONTEÚDO	€
HSSCo	PAV67CM2	6	P	Ø 6,3 - 8,3 - 10,4 12,4 - 16,5 - 20,5 mm	270,70

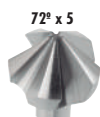
HARDOX
500

AV55	Ref.	Uds.		CONTEÚDO	€
HSSCo	PAV55CM2	6	P	Ø 6,3 - 8,3 - 10,4 12,4 - 16,5 - 20,5 mm	270,70



AV6MD	Ref.	Uds.		CONTEÚDO	€
MD	PAV6MDCM2	6	P	Ø 6,3 - 8,3 - 10,4 12,4 - 16,5 - 20,5 mm	586,17

HARDOX
500

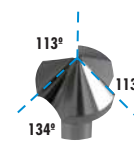

AV55MD	Ref.	Uds.		CONTEÚDO	€
MD	PAV55MDCM2	6	P	Ø 6,3 - 8,3 - 10,4 12,4 - 16,5 - 20,5 mm	818,08



AV66MD	Ref.	Uds.		CONTEÚDO	€
MD	PAV66MDCM2	6	P	Ø 6,3 - 8,3 - 10,4 12,4 - 16,5 - 20,5 mm	654,47

ESTOJOS DE ESCAREADORES

DIN 334C

AV8	Ref.	Uds.		CONTEÚDO	€
	AV8CM2	6	M	Ø 6,3 - 8 - 10 12,5 - 16 - 20 mm	217,46
HSS	AV8CM3	7	M	Ø 6,3 - 8,0 - 10 12,5 - 16 - 20 - 25 mm	281,14

NORMA CELESA

AV9	Ref.	Uds.		CONTEÚDO	€
	AV9CM1	6	M	Ø 6,3 - 8,3 - 10,4 12,4 - 16,5 - 20,5 mm	222,42
HSS	AV9CM5	7	M	Ø 6,3 - 8,3 - 10,4 12,4 - 16,5 - 20,5 - 25 mm	287,82

* Outros estojos, AV99, etc., sob demanda.

 90°

AV1	Ref.	Uds.		CONTEÚDO	€
HSS	AV1S2	5	M	Ø 10 - 14 20 - 27 - 30 mm	314,70

* Até o fim das existências.

HSS

DIN 373

AV2M	Ref.	Uds.		CONTEÚDO	€
FINO	AV2M3-10	6	M	M3-M4-M5-M6-M8-M10	187,85
	AV2M3-12	7	M	M3-M4-M5-M6-M8-M10-M12	241,26

AV2MM	Ref.	Uds.		CONTEÚDO	€
MEIO	AV2M3-10M	6	M	M3-M4-M5-M6-M8-M10	203,37
	AV2M3-12M	7	M	M3-M4-M5-M6-M8-M10-M12	261,17

AV2GM	Ref.	Uds.		CONTEÚDO	€
FURO ROSCADO	AV2M3-10G	6	M	M3-M4-M5-M6-M8-M10	203,37
	AV2M3-12G	7	M	M3-M4-M5-M6-M8-M10-M12	261,17



NORMA CELESA

Ref. AV10CM6

AV10	Ref.	Uds.		CONTEÚDO	€
	AV10CM1	6	M	Ø 6,3 - 8,3 - 10,4 12,4 - 16,5 - 20,5 mm	250,23
HSS	AV10CM6	7	M	Ø 6,3 - 8,3 - 10,4 12,4 - 16,5 - 20,5 - 25 mm	309,74



AV1



AV2

AV2MM

AV2GM

Ref. AV2M3-10

REBARBADOR DE PRECISÃO

OS REBARBADORES BLUE-MASTER

Os rebarbadores BLUE-MASTER são utilizados para eliminar as limanhas acumuladas nas bordas e arestas de peças fabricadas em metal, plástico ou madeira. O sistema completa-se juntando os três componentes indicados: LÂMINA + PORTA-LÂMINAS + CABO UNIVERSAL. O cabo pode ser utilizado com todos os grupos de lâminas, trocando o porta-lâminas para cada um deles.

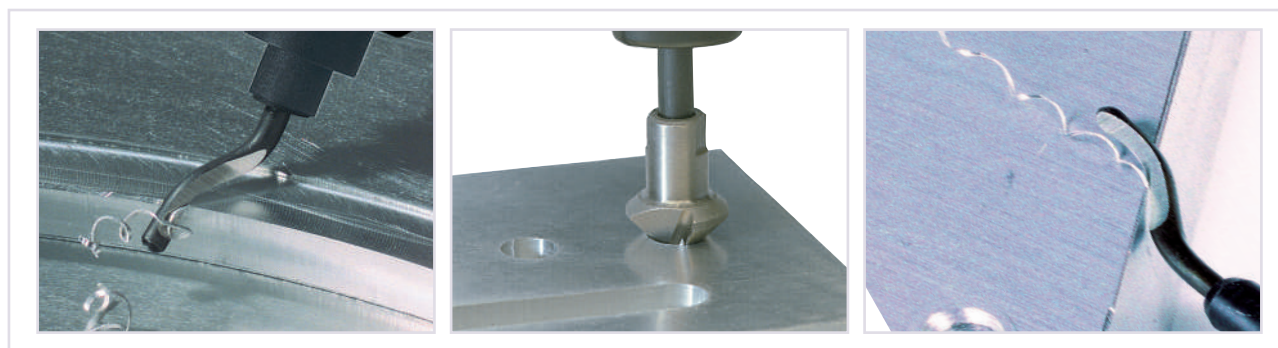
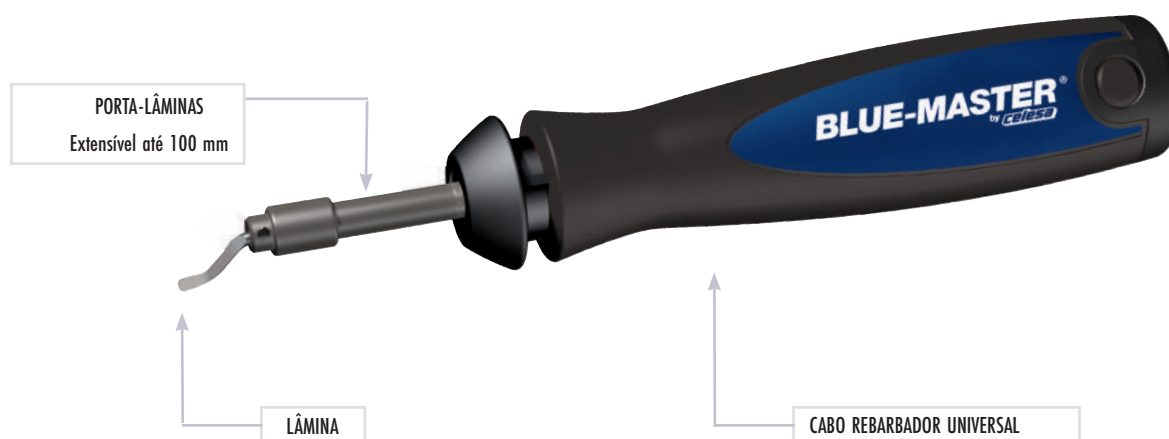

CONJUNTO B

JRB1

Conteúdo B:

Ref. RB10



Ref. RB20



Ref. RBB1



Ref. RBB

 Blister: **33,63 €**

CONJUNTO C

JRB2

Conteúdo C:

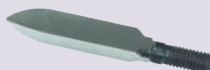

Ref. RC42



Ref. RBB1



Ref. RBC

 Blister: **61,24 €**

CONJUNTO D

JRB3

Conteúdo D:



Ref. RD80MD



Ref. RBB1



Ref. RBD

 Blister: **96,54 €**

CONJUNTO E

JRB4

Conteúdo E:



Ref. RE10



Ref. RE20

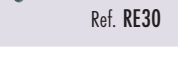

Ref. RE30



Ref. RBB1



Ref. RBE

 Blister: **37,45 €**

REBARBADOR DE PRECISÃO

GRUPO B

PORTA-LÂMINAS GRUPO B



Ø2,6mm

RBB
11,80 €

Para lâminas rebarbadoras GRUPO B.

LÂMINAS GRUPO B



Lâmina rebarbadora.
Serie curta: Aço, alumínio, fundição.

RB10*

Blister 10 U.: **2,18 €**/U.



Lâmina de punção de metal duro.

RB50*

Blister 1 U.: **38,85 €**



Lâmina rebarbadora bidirecional.
Serie curta: latão, fundição.

RB20

Blister 10 U.: **2,18 €**/U.



Lâmina rebarbadora para parte posterior duma furação de até 20mm de profundidade.

RB60*

Blister 10 U.: **5,16 €**/Ud



Lâmina rebarbadora dupla aresta furos de 4mm de profundidade.

RB30

Blister 10 U.: **2,18 €**/U.



Lâmina rebarbadora de arestas exteriores.

RB70MD*

Blister 1 U.: **44,20 €**

*Até o fim das existências.

GRUPO C

PORTA- LÂMINAS GRUPO C



Para lâminas rebarbadoras GRUPO C.

RBC

Blister 1U.: **11,80 €**

LÂMINAS GRUPO C



Lâmina raspador largo 4 x 20 mm.

RC40*

Blister 1 U.: **24,06 €**



Lâmina raspador largo 8 x 30 mm.

RC42*

Blister 1 U.: **29,93 €**

*Até o fim das existências.

GRUPO D

PORTA- LÂMINAS GRUPO D



Para lâminas rebarbadoras GRUPO D.

RBD

Blister 1 U.: **11,80 €**

LÂMINAS GRUPO D



Lâmina rebarbadora de metal duro em "V" fêmea cantos de até 3 mm.

RD80MD*

Blister 1 U.: **62,90 €**



Lâmina rebarbadora de metal duro em "V" fêmea cantos de até 8 mm.

RD82MD*

Blister 1 U.: **98,61 €**

*Até o fim das existências.

CABO REBARBADOR UNIVERSAL

Utilizações gerais.
 Válido para porta-lâminas:
 Ref. RBB / RBC / RBD / RBE / RBF

RBB1

 Blister 1 ud.: **15,51 €**
REBARBADOR DE PRECISÃO
**GRUPO
E**

PORTA- LÂMINAS GRUPO E



Para lâminas rebarbadoras Grupo E.

RBE

 Blister 1 ud.: **11,80 €**
LÂMINAS GRUPO E

Lâmina rebarbadora
 para interiores e exteriores.
 Serie longa: Aço, alumínio, plástico.

RE10

 Blister 10 ud.: **2,67 €/Ud**

Lâmina rebarbadora para cantos retos:
 chaveteros, ...

RE35

 Blister 10 ud.: **2,86 €/Ud**

Lâmina rebarbadora bidirecional: latão, fundição.

RE20

 Blister 10 ud.: **2,67 €/Ud**

Lâmina rebarbadora fechada dupla aresta
 para furos de 4mm de profundidade.

RE30

 Blister 10 ud.: **2,67 €/Ud**

Lâmina rebarbadora para parte posterior
 duma furação de até 20mm de profundidade.

RE60*

 Blister 5 ud.: **3,75 €/Ud**

*Até o fim das existências.

**GRUPO
F**

PORTA- LÂMINAS GRUPO F



Para lâminas rebarbadoras Grupo F.

RBF

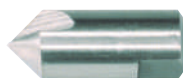
 Blister 1 ud.: **11,80 €**
LÂMINAS GRUPO F (Rosca M05 x 0,80)

Lâmina escareadora HSS Ø 12 mm.

RF12

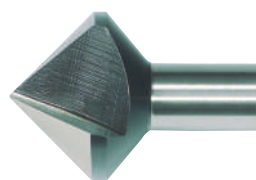
 Blister 1 ud.: **26,55 €**

Lâmina escareadora HSS Ø 30 mm.

RF30

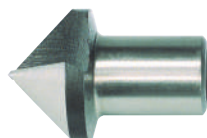
 Blister 1 ud.: **88,72 €**

Lâmina escareadora HSS Ø 20 mm.

RF20

 Blister 1 ud.: **51,32 €**