

ESCAREADORES

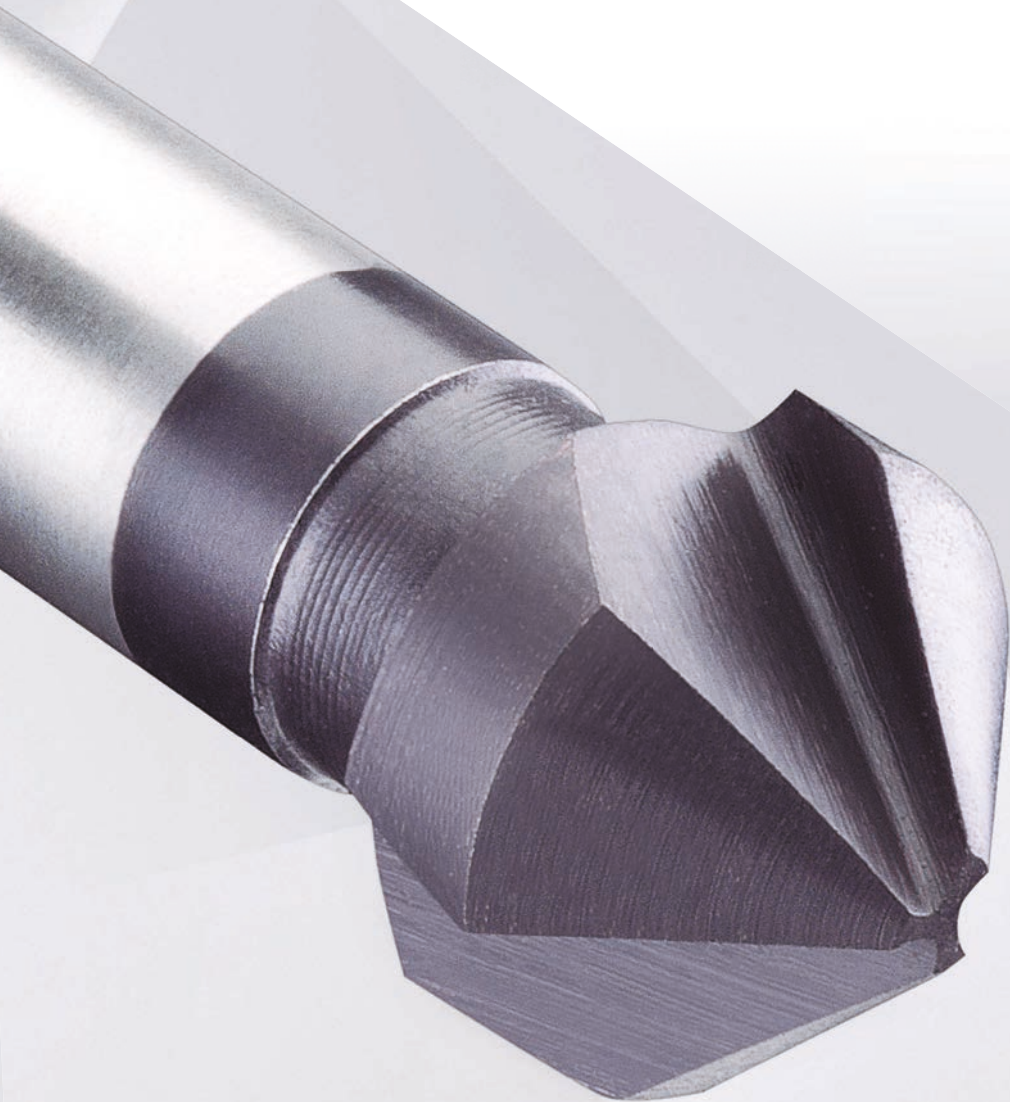

BLUE-MASTER[®]
by CELESA

CUTTING TECHNOLOGIES

BROCAS-ESCREADORAS E ESCALONADAS PARA TUBO, CHAPA HSS E HSSCo
HSS

Ref. AV30

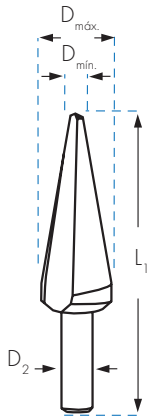

118°

BM0 BM1 BM5 BM3 BM4 BM6

AV30

	D mín. mm	D máx. mm	D ₂ mm	L ₁ mm	HSS	TiN
					€	€
AV30BM0B	3,0	14,0	6,0	58	19,54	39,06
AV30BM8B	3,0	22,5	8,0	85	54,03	97,91
AV30BM5B	3,0	31,0	10,0	102	86,40	129,48
AV30BM9B	5,0	25,4	10,0	87	61,44	117,37
AV30BM1B	6,0	20,0	8,0	63	27,57	57,00
AV30BM2B	16,0	30,0	10,0	79	53,33	94,32
AV30BM3B	26,0	40,0	13,0	86	110,34	172,79
AV30BM4	36,0	50,0	13,0	89	162,52	250,70
AV30BM6	40,0	61,0	13,0	98	269,24	419,29

* As referências terminadas em B, fornecem-se em blister.

HSSCo

Ref. AVC30

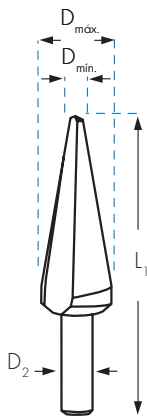

118°

BM0 BM1 BM2 BM3

AVC30

	D mín. mm	D máx. mm	D ₂ mm	L ₁ mm	HSSCo	TiN
					€	€
AVC30BM0B	3,0	14,0	6,0	58	36,17	47,25
AVC30BM1B	6,0	20,0	8,0	63	47,96	72,84
AVC30BM2B	16,0	30,0	10,0	79	79,14	105,51
AVC30BM3B	26,0	40,0	13,0	86	205,91	222,21

BROCAS-ESCREADORAS PARA CHAPA HSS CARACTERÍSTICAS ESPECIAIS

HSS

Ref. AG

Broca escareadora para cortar tubos e chapas de aço, ligas leves e materiais plásticos. Indicado até 5mm de profundidade.

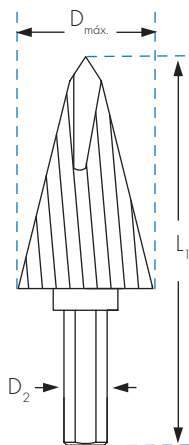

FRESA PARA TUBO E CHAPA

	D máx. mm	D ₂ mm	L ₁ mm	Nº dentes	AG HSS €
AG2500	25,0	8,0	72	20	27,59
AG3200	32,0	10,0	81	30	41,43
AG4500	45,0	10,0	94	36	68,43

HSS

Ref. AV31



TOPE DE PROFUNDIDADE

	D _{mín.} mm	D _{máx.} mm	D ₂ mm	L ₁ mm	AV31 HSS €	TiN €
AV31BM0B	3,0	7,8	6,0	48	31,32	47,40
AV31BM1B	3,0	10,2	6,0	52	41,13	64,48
AV31BM2B	3,0	11,8	6,0	56	45,77	80,88

BROCAS ESCALONADAS DE CANAIS RETOS HSS

Escareadores

Rosa

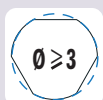

Ref. AV40

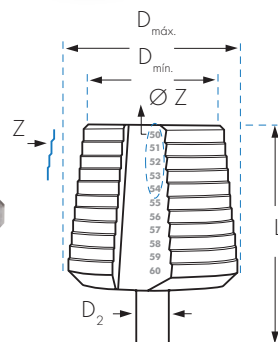
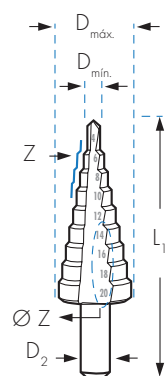

BM1

BM2

BM3

BM4

BM5

Ref. AV40BM25 / 26 / 27 / 28 / 29

AV40

	D mín. mm	D máx. mm	D ₂ mm	L ₁ mm	Z	Ø Z mm menor-maior	HSS €	TiN €
AV40BM1B	4,0	12,0	6,0	65	5	4-6-8-10-12	40,72	62,38
AV40BM2B	4,0	12,0	6,0	65	9	4-5-6-7-8-9-10-11-12	40,55	62,74
AV40BM3B	4,0	20,0	8,0	69	9	4-6-8-10-12-14-16-18-20	51,99	80,08
AV40BM4B	4,0	30,0	10,0	96	14	4-6-8-10-12-14-16-18-20-22-24-26-28-30	85,28	130,00
AV40BM14	4,0	39,0	10,0	107	13	4-6-9-12-15-18-21-24-27-30-33-36-39	211,59	326,75
AV40BM16B	5,0	28,0	10,0	69	7	5-8,8-11,8-15,3-19-24,5-28	98,15	154,46
AV40BM35B	5,0	35,0	13,0	80	13	5-7-10-12-15-17-20-22-25-27-30-32-35	127,06	184,74
AV40BM11B	6,0	25,0	10,0	65	7	6-9-12-16-20-22,50-25	80,15	114,77
AV40BM10B	6,0	26,7	10,0	75	8	6-9-11,40-14-17,25-19-21,25-26,75	156,05	245,56
AV40BM17B	6,0	30,5	10,0	80	9	6-9-12,5-15,2-18,6-20,4-22,5-28,3-30,5	165,68	260,71
AV40BM12B	6,0	32,0	10,0	75	9	6-9-12-16-20-22,5-25-28,5-32	113,12	154,64
AV40BM18B	6,0	37,0	10,0	100	12	6-9-12,5-15,2-18,6-20,4-22,5-26-28,3-30,5-34-37	184,13	285,40
AV40BM5B	6,0	38,0	10,0	96	12	6-9-13-16-19-21-23-26-29-32-35-38	198,66	284,04
AV40BM13	6,0	40,0	13,0	105	16	6-11-17-23-29-30-31-32-33-34-35-36-37-38-39-40	273,95	336,61
AV40BM15B	6,5	32,5	10,0	79	9	6,50-8,50-10,50-12,50-16,50-20,50-25,50-29-32,50	130,97	183,55
AV40BM20	6,5	40,5	10,0	96	11	6,50-8,50-10,50-12,50-16,50-20,50-25,50-29-32,50-36,50-40,50	205,33	323,12
AV40BM21B	7,0	20,0	10,0	80	12	7-10-11-12-13-14-15-16-17-18-19-20	82,16	129,28
AV40BM22B	10,0	30,0	13,0	83	12	10-20-21-22-23-24-25-26-27-28-29-30	128,60	201,76
AV40BM25B	12,0	20,0	8,0	66	9	12-13-14-15-16-17-18-19-20	76,17	101,95
AV40BM26B	20,0	30,0	10,0	78	11	20-21-22-23-24-25-26-27-28-29-30	111,12	156,53
AV40BM27	30,0	40,0	10,0	78	11	30-31-32-33-34-35-36-37-38-39-40	166,43	214,27
AV40BM28	40,0	50,0	13,0	85	11	40-41-42-43-44-45-46-47-48-49-50	237,92	331,60
AV40BM29	50,0	60,0	13,0	85	11	50-51-52-53-54-55-56-57-58-59-60	299,78	372,38

PARA TUBULAÇÕES ROSCA GAS

AV40BM6B	6,0	32,0	10,0	75	8	6-9-11,20(1/8)-14,50(1/4)-18,20(3/8)-22,30(1/2)-27,90(3/4)-32	117,36	160,88
----------	-----	------	------	----	---	---	--------	--------

PARA REBITES CEGOS M3 - M4 - M5 - M6 E M7

AV40BM7B	4,8	10,6	6,0	54	5	4,80-6,40-7,20-9,60-10,65	38,24	54,56
----------	-----	------	-----	----	---	---------------------------	-------	-------

PARA CONDUÇÕES ELÉTRICAS (ANTIGA E NOVA NORMA)

AV40PG21B	PG7	PG21	13,0	70	11	6,5-8,5-10,5-12,5(PG7)-15,2(PG9)-18,6(PG11) 20,4(PG13,5)-22,5(PG16)-25,5-18,3(PG21)-30,5	129,23	182,70
AV40PG29B	PG7	PG29	13,0	81	14	6,5-9-11-12,5(PG7)-15,2(PG9)-18,6(PG11)-20,4(PG13,5) 22,5(PG16)-26-28,3(PG21)-30,5-33-35-37(PG29)	166,95	234,20
AV40BM8B	8,5	32,5	10,0	70	12	8,5-10,5-12,5-14,5-16,5-18,5-20,5-23,5-25,5 28-30,5-32,5	97,97	150,64
AV40BM9B	8,5	40,5	12,0	84	16	8,5-10,5-12,5-14,5-16,5-18,5-20,5-23,5-25,5 28-30,5-32,5-34,5-36,5-38,5-40,5	143,69	224,93

BROCAS ESCALONADAS DE CANAIS RETOS HSSCo

HSSCo **INOX** Ref. AVC40

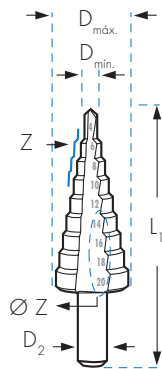

								AVC40	
	D mín. mm	D máx. mm	D ₂ mm	L ₁ mm	Z	Ø Z mm menor-maior	HSSCo €	TiN €	
AVC40BM1B	4,0	12,0	6,0	65	5	4-6-8-10-12	62,60	90,33	
AVC40BM2B	4,0	12,0	6,0	65	9	4-5-6-7-8-9-10-11-12	66,10	109,10	
AVC40BM3B	4,0	20,0	8,0	69	9	4-6-8-10-12-14-16-18-20	99,91	123,61	
AVC40BM4B	4,0	30,0	10,0	96	14	4-6-8-10-12-14-16-18-20-22-24-26-28-30	143,70	193,77	
AVC40BM18B	6,0	37,0	10,0	100	12	6-9-12,5-15,2-18,6-20,4-22,5-26-28,3-30,5-34-37	257,43	325,55	

BROCAS ESCALONADAS DE CANAIS HELICOIDAIS HSS

HSS Ref. AV42

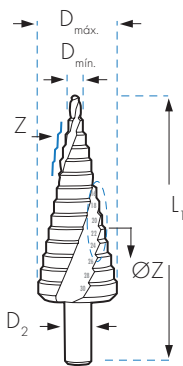

								AV42	
	D mín. mm	D máx. mm	D ₂ mm	L ₁ mm	Z	Ø Z mm menor-maior	HSS €	TiN €	
AV42BM1B	4,0	12,0	6,0	65	5	4-6-8-10-12	53,78	72,73	
AV42BM2B	4,0	12,0	6,0	68	9	4-5-6-7-8-9-10-11-12	55,63	75,74	
AV42BM3B	4,0	20,0	8,0	69	9	4-6-8-10-12-14-16-18-20	74,20	105,89	
AV42BM4B	4,0	30,0	10,0	96	14	4-6-8-10-12-14-16-18-20-22-24-26-28-30	118,03	168,58	
AV42BM5B	6,0	38,0	10,0	96	12	6-9-13-16-19-21-23-26-29-32-35-38	230,22	300,73	
AV42BM11B	6,0	25,0	10,0	65	7	6-9-12-16-20-22,50-25	95,53	124,20	
AV42BM12B	6,0	32,0	10,0	75	9	6-9-12-16-20-22,5-25-28,5-32	124,60	156,30	
AV42BM13	6,0	40,0	13,0	105	16	6-11-17-23-29-30-31-32-33-34-35-36-37-38-39-40	275,03	355,09	
AV42BM8B	8,5	32,5	10,0	70	12	8,5-10,5-12,5-14,5-16,5-18,5-20,5-23,5 25,5-28-30,5-32,5	125,76	162,53	
AV42BM9B	8,5	40,5	12,0	84	16	8,5-10,5-12,5-14,5-16,5-18,5-20,5-23,5 25,5-28-30,5-32,5-34,5-36,5-38,5-40,5	197,76	240,53	

BROCAS ESCALONADAS PARA CHAPA HSS CARACTERÍSTICAS ESPECIAIS
HSS
CABO SEXTAVADO 1/4"

	D mín. mm	D máx. mm		L ₁ mm	Z	Ø Z mm menor-maior	AV41	
							HSS €	TiN €
AV41BM2B	4,0	12,0	1/4"	72	9	4-5-6-7-8-9-10-11-12	89,48	110,95
AV41BM3B	4,0	20,0	1/4"	81	9	4-6-8-10-12-14-16-18-20	118,29	146,71
AV41BM4B	4,0	30,0	1/4"	105	14	4-6-8-10-12-14-16-18-20-22-24-26-28-30	140,21	168,90



Ref. AV41BM2B

SERIE CURTA Máximo 2 mm de espessura

	D mín. mm	D máx. mm	D ₂ mm	L ₁ mm	Z	Ø Z mm menor-maior	AV41C	
							HSS €	TiN €
AV41CBM2B	4,0	12,0	6,0	48	9	4-5-6-7-8-9-10-11-12	63,67	85,46
AV41CBM3B	4,0	20,0	8,0	58	9	4-6-8-10-12-14-16-18-20	79,05	110,45
AV41CBM4B	4,0	30,0	10,0	72	14	4-6-8-10-12-14-16-18-20-22-24-26-28-30	128,87	198,42



Ref. AV41CBM3B

APARAFUSAMENTOS MÉTRICOS DE CABO

	DIN	D mín. mm	D máx. mm	D ₂ mm	L ₁ mm	Z	Ø Z mm menor-maior	AV45	
								HSS €	TiN €
AV45BM0B	60423	5,3	30,5	10,0	79	9	5,3-7-9-10,5-14,5-18,5-23,5-27-30,5	175,67	226,53
AV45BM2B	60423	5,3	38,5	10,0	96	11	5,3-7-9-10,5-14,5-18,5-23,5-27-30,5-34,5-38,5	211,25	266,90



Ref. AV45BM2B

ESCALONADA RETA COM 3 CANAIS

	D mín. mm	D máx. mm	D ₂ mm	L ₁ mm	Z	Ø Z mm menor-maior	AV43	
							HSS €	TiN €
AV43BM1B	4,0	12,0	6,0	65	9	4-5-6-7-8-9-10-11-12	76,74	100,41
AV43BM2B	4,0	20,0	8,0	75	9	4-6-8-10-12-14-16-18-20	105,21	163,02
AV43BM3B	4,0	30,0	10,0	100	14	4-6-8-10-12-14-16-18-20-22-24-26-28-30	154,68	252,99

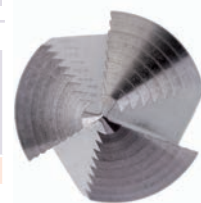

Ref. AV43BM3B

BROCA ESCALONADA COM BROCA GUIA INTERCAMBIÁVEL

	D mín. mm	D máx. mm	D ₂ mm	L ₁ mm	Z	Ø Z mm menor-maior	AV4	
							HSS €	
AV4BM3040	30,0	40,0	13,0	76	11	30-31-32-33-34-35-36-37-38-39-40	161,00	
AV4BM4050	40,0	50,0	13,0	76	11	40-41-42-43-44-45-46-47-48-49-50	232,54	
AV4BM5060	50,0	60,0	13,0	76	11	50-51-52-53-54-55-56-57-58-59-60	295,19	



Ref. AV4BM3040

BROCA GUIA

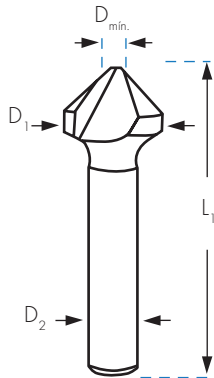

		BAV4BM
		€
BAV4BM	DESCRIÇÃO	10,42
	10X35mm	

ESCAREADORES DE 3 CANAIS

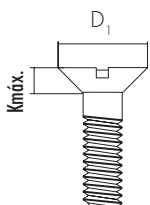

				AV6	AV16	AV37	AV7	AV38	AV99	AV6MD	AV15	
MATERIAL				HSS	HSS	HSS	HSSCo	HSSCo	HSSCo	MD	HSS	
ACABAMENTO					TiN	TiAlN		TiAlSiN	TiAlN			
APLICAÇÃO				UTILIZAÇÃO GERAL	UTILIZAÇÃO GERAL	UTILIZAÇÃO GERAL	UTIL. GERAL INOX	INOX Plus	INOX SpheroPlus Al	HARDOX 450		
D1 mm	D min. mm	D2 mm	L1 mm	€	€	€	€	€	€	€	L1 mm	€
4,30	1,3	4,0	40	17,53	32,38	38,12	19,50	46,57		65,77		
5,00	1,5	4,0	40	17,53	32,38	38,12	19,50	46,57				
5,30	1,5	4,0	40	17,53	32,38	38,12	19,50	46,57		63,32		
5,80	1,5	5,0	45	13,31	28,45	35,78	15,87	40,77				
6,00	1,5	5,0	45	12,69	27,83	35,78	15,25	40,27		65,43		
6,30	1,5	5,0	45	12,46	27,83	35,78	14,97	40,05	40,49	70,74		
7,00	1,8	6,0	50	17,53	37,15	47,72	19,50	54,16				
7,30	1,8	6,0	50	17,53	37,15	47,72	19,50	54,16				
8,00	2,0	6,0	50	17,53	37,15	47,72	19,71	54,31		75,36		
8,30	2,0	6,0	50	17,27	37,15	47,72	19,35	54,01	54,61	80,37		
9,40	2,2	6,0	50	20,44	41,92	53,47	22,81	61,48				
10,00	2,5	6,0	50	20,44	41,92	53,47	22,81	61,48		83,07		
10,40	2,5	6,0	50	20,07	41,92	53,47	23,29	61,31	61,99	87,66	112	62,39
11,50	2,8	8,0	56	20,54	44,41	57,49	24,89	66,64				
12,00	2,8	8,0	56	20,54	44,41	57,49	24,89	66,65				
12,40	2,8	8,0	56	20,54	44,41	57,49	24,88	66,65	67,39	91,41	112	76,81
13,40	2,9	8,0	56	22,21	45,88	59,38	27,15	69,80				
15,00	3,2	10,0	60	28,20	61,65	81,30	34,57	93,39		95,20		
16,50	3,2	10,0	60	27,73	63,31	81,30	34,10	92,97	94,01	100,11	120	92,56
19,00	3,5	10,0	63	41,53	77,24	98,66	51,13	113,54				
20,50	3,5	10,0	63	40,82	78,89	101,63	50,20	114,99	116,26	138,81	124	124,06
23,00	3,8	10,0	67	51,05	89,87	113,73	62,31	133,53				
25,00	3,8	10,0	67	51,51	91,14	114,91	63,42	135,31	136,81	226,50	128	149,62
28,00	4,0	12,0	71	71,93	115,85	148,70	90,57	181,84				
30,00	4,2	12,0	71	76,44	120,20	193,78	95,79	219,29				
31,00	4,2	12,0	71	79,57	124,59	208,09	95,79	214,54		255,58	133	175,27
40,00	6,5	13,0	80	118,32	190,15	244,66	149,54	267,75		443,75*		

* Cabo de 16 mm



DIMENSÕES PARAFUSO CABEÇA CÔNICA 90°

	M2	M2.5	M3	M4	M5	M6	M8	M10	M12	M14	M16	M18	M20
Kmáx.	1,2	1,5	1,7	2,3	2,8	3,3	4,4	5,5	6,5	7	7,5	8	8,5
D1	4	5	6	8	10	12	16	20	24	27	30	33	36

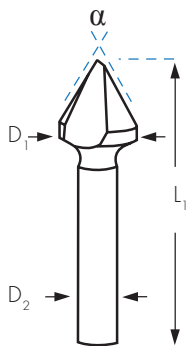
ESCAREADORES HSS CABO CILÍNDRICO 60°, 75° E 120°
3Z

				AV8	AV9	AV10
MATERIAL				HSS	HSS	HSS
NORMA				DIN 334C	NORMA CELESA	NORMA CELESA
ÂNGULO DA PONTA				60°	75°	120°
D ₁ mm	D _{mín} mm	D ₂ mm	L ₁ mm	€	€	€
6,30	1,5	5,0	45	AV80630 20,06	AV90630 15,44	AV100630 16,44
8,00	2,0	6,0	50	AV80800 22,05		
8,30	2,0	6,0	50		AV90830 21,05	AV100830 22,65
10,00	2,5	6,0	50	AV81000 24,05		
10,40	2,5	6,0	50		AV91040 24,87	AV101040 26,47
12,40	2,8	8,0	56	AV81250 26,67	AV91240 27,48	AV101240 31,69
16,50	3,2	10,0	60	AV81600 34,11	AV91650 34,47	AV101650 40,10
20,50	3,5	10,0	63	AV82000 48,14	AV92050 50,74	AV102050 59,16
25,00	3,8	10,0	67	AV82500 67,18	AV92500 63,96	AV102500 74,61
40,00	6,5	13,0	67	AV84000 154,34	AV94000 139,16	AV104000 163,99

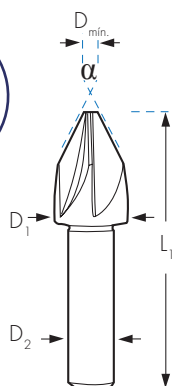
ESCAREADORES MULTI-CORTE CABO CILÍNDRICO 60°, 90° E 120°
5Z

				AV12	AV11	AV13			
MATERIAL				HSS	HSS	HSS			
DIN				DIN 334A	DIN 335A	DIN 347A			
ÂNGULO DA PONTA				60°	90°	120°			
D ₁ mm	D _{mín} mm	D ₂ mm	Nº Z	L ₁ mm	€	L ₁ mm	€	L ₁ mm	€
8,00	2,5	8,0	5	AV120800 48	17,53	AV110800 44	13,18	AV130800 44	17,47
12,50	2,8	8,0	5	AV121250 52	24,53	AV111250 48	19,31	AV131250 48	25,65
16,00	3,0	10,0	5	AV121600 60	41,16	AV111600 56	32,42	AV131600 56	43,03
20,00	3,5	10,0	5	AV122000 64	53,09	AV112000 60	41,76	AV132000 60	55,48
25,00	3,5	10,0	5	AV122500 69	74,31	AV112500 65	58,46	AV132500* 65	75,47

* D₂: 12,00 mm

ESCREADORES HSS E HSSCo PARA REBARBAR COM FURO

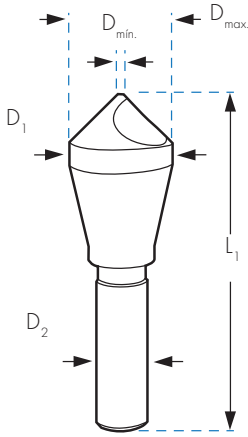

MATERIAL					AV1	AV1T	AV2	AV2T	AV1-60					
ACABAMENTO					HSS	HSS	HSSCo	HSSCo	HSS					
ÂNGULO DA PONTA														
D1 mm	D _{mín} mm	D _{max} mm	D2 mm	L1 mm	€	€	€	€	€					
6,35	2,0	5,0	6,35	45	AV100	14,31	AV100T	25,85	AV200	24,32	AV200T	40,91	AV100-60	25,63
10,00	2,0	5,0	6,00	45	AV101	17,64	AV101T	27,04	AV201	25,12	AV201T	40,91	AV101-60	32,02
14,00	6,0	13,0	8,00	50	AV102	22,04	AV102T	38,01	AV202	29,25	AV202T	51,01	AV102-60	38,87
20,00	8,0	18,0	10,00	65	AV103	39,46	AV103T	67,96	AV203	52,29	AV203T	86,34	AV103-60	44,34
27,00	11,0	25,0	12,00	85	AV104	70,52	AV104T	111,72	AV204	85,20	AV204T	136,02	AV104-60	77,25
30,00	12,0	28,0	15,00	95	AV105	119,02	AV105T	212,01	AV205	135,37	AV205T	233,72	AV105-60	126,60
35,00	14,0	33,0	15,00	100	AV106	182,80	AV106T	290,30	AV206	226,81	AV206T	393,05	AV106-60	200,63
40,00	16,0	38,0	15,00	110	AV107	252,39	AV107T	412,58	AV207	260,96	AV207T	421,11	AV107-60	271,91
45,00	18,0	42,0	15,00	120	AV108	334,41	AV108T	501,09	AV208	392,18	AV208T	558,65	AV108-60	351,42
50,00	20,0	48,0	15,00	130	AV109	403,49	AV109T	582,58	AV209	522,70	AV209T	701,38	AV109-60	428,19

ESCREADORES CÔNICOS 90° MULTI-NAVALHA

Ref. FC

TiAlN MD

D1 mm	D2 mm	L mm	L2 mm	D3 mm	Z	FC	€
0,5	0,1	39,0	3,0	3,0	3	FC0050	63,95
0,6	0,1	39,0	3,0	3,0	3	FC0060	63,95
0,7	0,1	39,0	3,0	3,0	3	FC0070	63,95
0,8	0,1	39,0	3,0	3,0	3	FC0080	63,95
0,9	0,1	39,0	3,0	3,0	3	FC0090	63,95
1,0	0,1	39,0	3,0	3,0	3	FC0100	61,74
1,5	0,1	39,0	4,5	3,0	3	FC0150	61,74
2,0	0,1	39,0	6,0	3,0	3	FC0200	61,74
2,5	0,1	39,0	7,5	3,0	3	FC0250	61,74
3,0	0,1	39,0	-	3,0	3	FC0300	61,74
4,0	0,8	54,0	-	4,0	4	FC0400	63,95
6,0	0,8	57,0	-	6,0*	4	FC0600	67,25
8,0	0,8	63,0	-	8,0*	5	FC0800	73,87
10,00	1,0	72,0	-	10,0*	6	FC1000	88,20
12,00	1,2	83,0	-	12,0*	6	FC1200	130,10
16,00	1,6	92,0	-	16,0*	6	FC1600	232,63
20,00	2,0	104,0	-	20,0*	6	FC2000	425,56

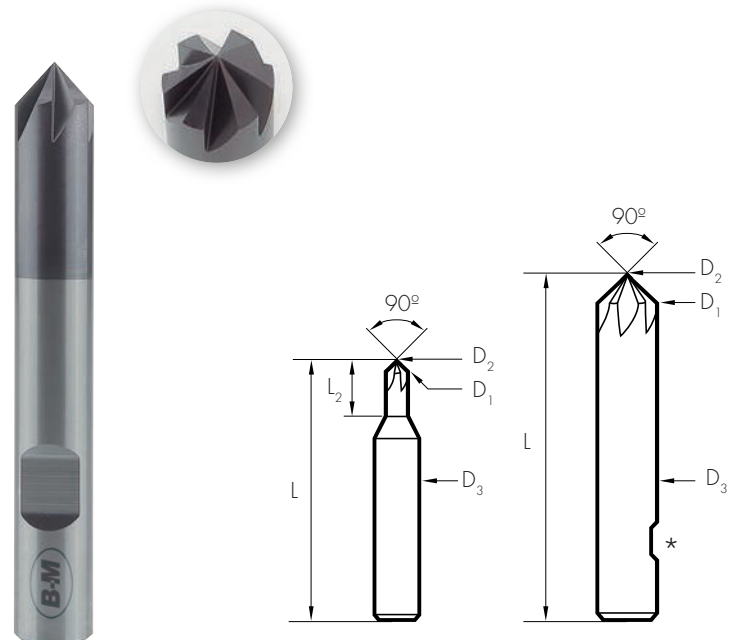

*Com plano de arrasto

ESCAREADORES COM CABO CÓNICO
3Z

Ref. AV17

DIN 335D
HSS

90°

Ref. AV17MD

DIN 335D
MD

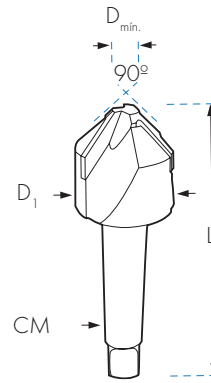
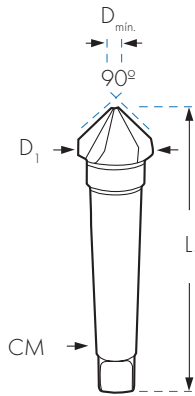
90°

AV17

D1 mm	D mín. mm	L1 mm	CM	€
16,50	4,0	90	1	84,05
20,50	3,5	100	2	99,09
25,00	3,8	106	2	100,11
31,00	4,2	112	2	111,43
40,00	10,0	140	3	171,48
50,00	14,0	150	3	215,86
63,00	16,0	180	4	349,02
80,00	22,0	190	4	597,18
100,00	25,0	210	4	1.539,10

AV17MD

D1 mm	D mín. mm	L1 mm	CM	€
63,00	16,0	190	4	1.460,79*
80,00	22,0	190	4	1.783,34*

*Até o fim das existências.

ESCAREADORES MULTI-CORTE COM CABO CÓNICO
**MULTI
CORTE**

Ref. AV23

DIN 334B

60°

Ref. AV18

DIN 335B

90°

Ref. AV24

DIN 347B

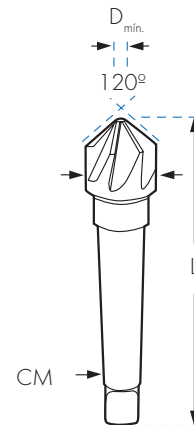
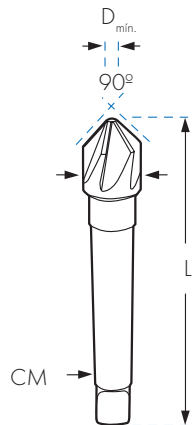
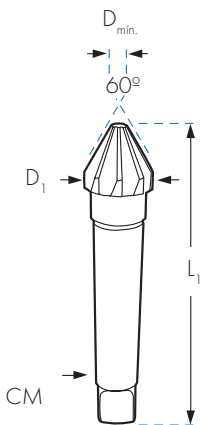
120°

AV23

D1 mm	D mín. mm	L1 mm	CM	Z	HSS €
16,00	3,2	93	1	7	63,77
20,00	4,0	116	2	7	74,65
25,00	7,0	121	2	9	81,77
31,50	9,0	124	2	9	111,81
40,00	12,5	150	3	11	204,63
50,00	16,0	153	3	13	244,61
63,00	20,0	185	4	15	374,47
80,00	25,0	196	4	17	578,74
100,00	22,0	230	4	3	1.823,64

AV18

D1 mm	D mín. mm	L1 mm	CM	Z	HSS €
16,00	3,2	93	1	7	65,04
20,00	4,0	116	2	7	76,06
25,00	7,0	121	2	9	83,41
31,50	9,0	124	2	9	114,08
40,00	12,5	150	3	11	208,77
50,00	16,0	153	3	13	249,44
63,00	20,0	185	4	15	358,12
80,00	25,0	196	4	17	590,36
100,00	22,0	190	4	20	1.591,39

AV24

D1 mm	D mín. mm	L1 mm	CM	Z	HSS €
16,00	3,2	93	1	7	66,23
20,00	4,0	116	2	7	77,51
25,00	7,0	121	2	9	89,02
31,50	9,0	124	2	9	116,13
40,00	12,5	150	3	11	184,91
50,00	16,0	153	3	13	238,84
63,00	20,0	185	4	15	388,86
80,00	25,0	196	4	17	601,00
100,00	27,0	210	4	3	1.577,33

ESCAREADORES DE 1 CANAL

HSS CABO CILÍNDRICO
Ref. AV27
Ref. AV29

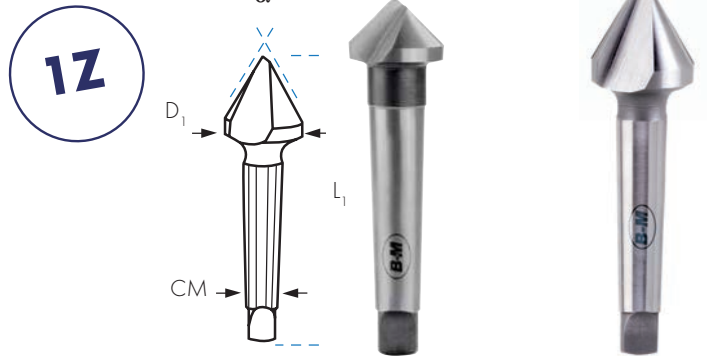
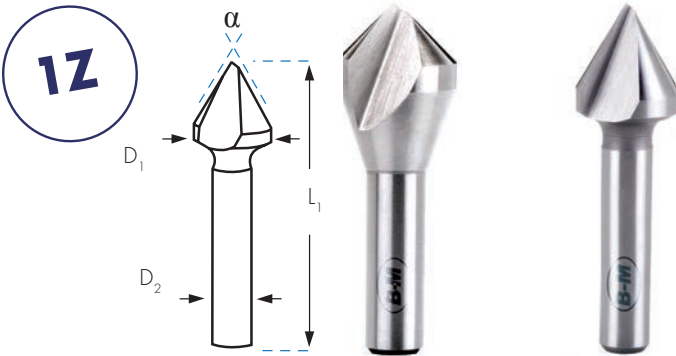

HSS CABO CÓNICO
Ref. AV34
Ref. AV28

	D1 mm	D2 mm	L1 mm	90° €	60° €
AV270600	6,0	5,0	45	13,77	AV290600 25,40
AV270800	8,0	8,0	50	14,54	AV290800 26,60
AV271000	10,0	8,0	50	15,41	AV291000 27,85
AV271200	12,0	8,0	50	17,94	AV291200 31,29
AV271600	16,0	10,0	56	21,37	AV291600 38,10
AV272000	20,0	10,0	60	29,20	AV292000 48,97
AV272500	25,0	10,0	75	38,47	AV292500 77,11
AV273000	30,0	12,0	80	55,49	AV293000 100,70
AV274000	40,0	13,0	89	144,59	AV294000 175,04
AV275000	50,0	13,0	98	178,51	AV295000 261,50

	D1 mm	CM	L1 mm	90° €	60° €
AV341600	16,0	1	92	66,20	AV281600 63,34
AV342000	20,0	2	107	82,97	AV282000 69,39
AV342500	25,0	2	110	106,84	AV282500 102,88
AV343000	30,0	2	114	121,41	AV283000 135,57
AV344000	40,0	3	145	195,35	AV284000 178,50
AV345000	50,0	3	152	285,25	AV285000 271,08

ESCAREADORES EXTERNOS DE 3 CANAIS

3Z **HSS** Ref. AVX **90°** Ref. AVX-60 **HSS** **60°**

AVX						AVX-60					
Dmáx. mm	Dmín. mm	D2 mm	L1 mm		€	Dmáx. mm	Dmín. mm	D2 mm	L1 mm		€
12,00	4,0	8,0	55	AVX1	57,62	8,00	3,0	8,0	55	AVX1-60	61,55
20,00	8,0	10,0	60	AVX2	107,34	15,00	6,0	10,0	60	AVX2-60	118,12
28,00	10,0	13,0	70	AVX3	152,27	28,00	10,0	13,0	75	AVX3-60	177,02
40,00	12,0	CM2	125	AVX4	231,07						
50,00	15,0	CM3	130	AVX5	322,83						

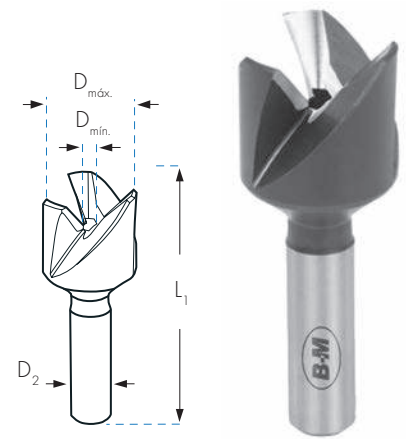

ESCAREADOR EXTERNO PARA REPARAÇÃO DE FIOS DE ENTRADA

Ref. AVEXT **HSS** **60°**



Min.-Max.	Hexagon	L1 mm		€
M8-M18	1/4"	75	AVEXT	37,48



ESCREADORES PARA PARAFUSOS «ALLEN»
CABO CILÍNDRICO
**DIN
373**
HSS

Ref. AV2

NOTA: a longitude de corte entende-se sem a guia.

* O ajustamento grosso usa-se para escarear furos roscados.

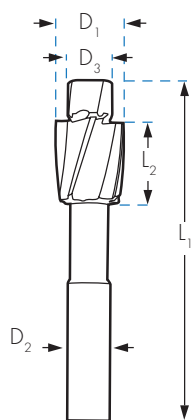
 Para escarear
furos roscados

AV2M

AV2MM

AV2GM

AJUSTAMENTO						AV2M		AV2MM		AV2GM			
	D1 mm	D2 mm	L1 mm	L2 mm		D3 mm	FINO €	D3 mm	MEIO €	D3 mm	FURO ROSCADO €		
M3	6,0	5,0	71	14	AV2M3	3,2	24,84	AV2MM3	3,4	26,89	AV2GM3	2,5	26,89
M4	8,0	5,0	71	14	AV2M4	4,3	24,84	AV2MM4	4,5	26,89	AV2GM4	3,3	26,89
M5	10,0	8,0	80	18	AV2M5	5,3	24,84	AV2MM5	5,5	26,89	AV2GM5	4,2	26,89
M6	11,0	8,0	80	18	AV2M6	6,4	28,00	AV2MM6	6,6	30,31	AV2GM6	5,0	30,31
M7	20,0	12,7	90	20	AV2M7	7,4	51,70						
M8	15,0	12,5	100	22	AV2M8	8,4	34,71	AV2MM8	9,0	37,57	AV2GM8	6,8	37,57
M10	18,0	12,5	100	22	AV2M10	10,5	41,32	AV2MM10	11,0	44,73	AV2GM10	8,5	44,73
M11	22,0	18,8	100	22	AV2M11	11,5	55,00						
M12	20,0	12,5	100	22	AV2M12	13,0	48,20	AV2MM12	14,0	52,18	AV2GM12	10,2	52,18
M14	24,0	12,5	100	22	AV2M14	15,0	75,40	AV2MM14	15,5	81,62	AV2GM14	12,0	81,62
M16	26,0	12,5	100	22	AV2M16	17,0	82,93	AV2MM16	17,5	89,77	AV2GM16	14,0	89,77

CABEÇA CÓNICA COM GUIA
**DIN
1866**
HSS

Ref. AV3

NOTA: A longitude de corte entende-se sem a guia.

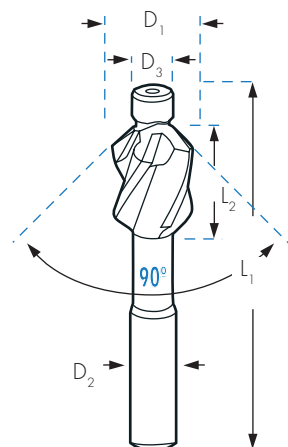

AJUSTAMENTO						AV3	
	D1 mm	D2 mm	L1 mm	L2 mm		D3 mm	FINO €
M3	6,3	6,0	71	14,0	AV3M3	3,2	33,98
M4	8,3	8,0	71	14,0	AV3M4	4,3	33,98
M5	10,4	10,0	80	18,0	AV3M5	5,3	33,98
M6	12,4	10,0	80	18,0	AV3M6	6,4	38,61
M8	16,5	12,0	100	22,0	AV3M8	8,4	47,25
M10	20,5	12,0	100	22,0	AV3M10	10,5	51,12
M12	24,5	13,0	110	25,0	AV3M12	13,0	62,31

ESCREADORES PARA PARAFUSOS «ALLEN»

CABO CÓNICO

Ref. AV5

**DIN
375**

HSS

NOTA: A longitude de corte entende-se sem a guia.

* O ajustamento grosso usa-se para escarear furos roscados.

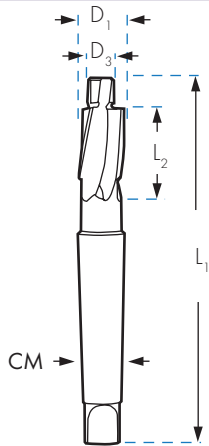

PARA ESCAREAR
FUROS ROSCADOS



AV5M

AV5MM

AV5GM

AJUSTAMENTO					AV5M		AV5MM		AV5GM				
	D1 mm	CM	L1 mm	L2 mm	D3 mm	FINO €	D3 mm	MEIO €	D3 mm	FURO ROSCADO €			
M8	15,0	2	132	22	AV5M8	8,4	67,27	AV5MM8	9,0	67,27	AV5GM8	6,8	67,27
M10	18,0	2	140	25	AV5M10	10,5	69,04	AV5MM10	11,0	69,04	AV5GM10	8,5	69,04
M12	20,0	2	140	25	AV5M12	13,0	76,39	AV5MM12	14,0	76,39	AV5GM12	10,2	76,39
M14	24,0	2	150	30	AV5M14	15,0	106,03	AV5MM14	15,5	106,03	AV5GM14	12,0	106,03
M16	26,0	3	180	35	AV5M16	17,0	124,51	AV5MM16	17,5	124,51	AV5GM16	14,0	124,51
M18	30,0	3	180	35	AV5M18	19,0	134,35	AV5MM18	20,0	134,35	AV5GM18	15,5	134,35
M20	33,0	3	190	40	AV5M20	21,0	146,38	AV5MM20	22,0	146,38	AV5GM20	17,5	146,38
M22	36,0	3	190	40	AV5M22	23,0	178,38	AV5MM22	24,0	178,38	AV5GM22	19,5	178,38
M24	40,0	3	190	40	AV5M24	25,0	215,64	AV5MM24	26,0	215,64	AV5GM24	21,0	215,64
M27	46,0	4	255	50	AV5M27	30,0	245,03						
M30	48,0	4	255	50	AV5M30	33,0	296,43						

APLICAÇÕES DOS TIPOS DE AJUSTAMENTOS: FINO, MEIO E FURO ROSCADO

T1: Parafusos cabeça cilíndrica DIN 84 e DIN 7984
Parafusos Auto-roscantes DIN 7513

T2 : Parafusos cabeça cilíndrica DIN 6912
T3 : Parafusos cabeça cilíndrica DIN 912

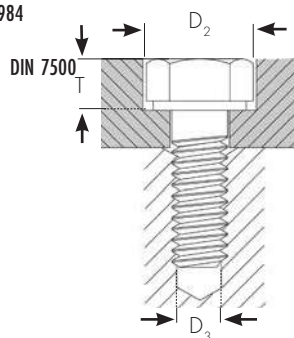

ROSCAS MÉTRICAS	FINO	MEIO	FURO ROSCADO	D2 mm	T1 mm	T2 mm	T3 mm
	D3 mm	D3 mm	D3 mm				
M3	3,2	3,4	2,5	6,0	2,4	--	3,4
M4	4,3	4,5	3,3	8,0	3,2	3,4	4,6
M5	5,3	5,5	4,2	10,0	4,0	4,2	5,7
M6	6,4	6,6	5,0	11,0	4,7	4,8	6,8
M8	8,4	9,0	6,8	15,0	6,0	6,0	6,0
M10	10,5	11,0	8,5	18,0	7,0	7,5	11,0
M12	13,0	13,5	10,2	20,0	8,0	8,5	13,0
M14	15,0	15,5	12,0	24,0	9,0	9,5	15,0
M16	17,0	17,5	14,0	26,0	10,5	11,5	17,5
M18	19,0	20,0	15,5	30,0	11,5	12,5	19,5
M20	21,0	22,0	17,5	33,0	12,5	13,5	21,5
M22	23,0	24,0	19,5	36,0	13,5	14,5	23,5

ESCAREADORES COM ELEMENTOS INTERCAMBIÁVEIS PARA PARAFUSOS COM CABEÇA "ALLEN" E CÔNICA

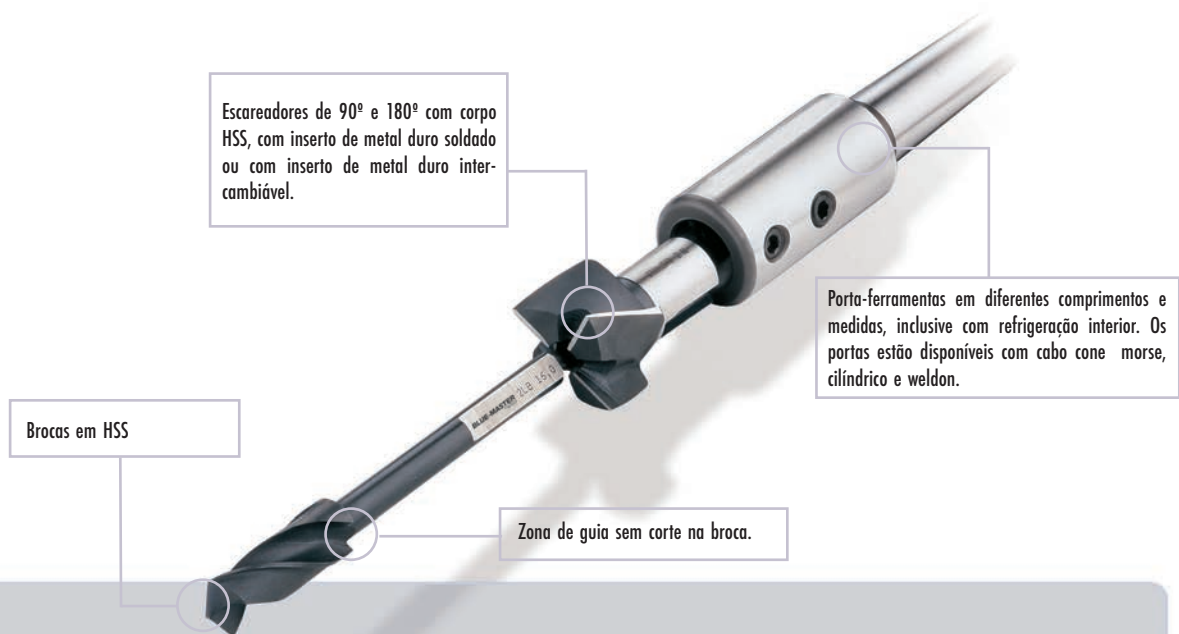

O SISTEMA BLUE-MASTER

O sistema BLUE-MASTER é único para operações de escareado, e ajuda a incrementar a produtividade e diminuir os custos.

Os nossos porta-ferramentas, fresas, brocas e guias podem combinar-se para adaptar-lhos a todos os tipos de máquinas e aplicações.

Você pode compor facilmente mais de 1.500.000 ferramentas especiais com só 1.300 peças.

O sistema consta de 3 grupos de dimensões: SERIE A, SERIE B e SERIE C.

Todas as combinações têm que fazer-se com elementos do mesmo grupo. Ferramentas de diferentes grupos não são combináveis entre si.

Nas seguintes páginas encontrará tanto as faixas de medidas disponíveis em cada grupo, como as recomendações para a correta escolha tanto da ferramenta como dos dados de corte.

Importante!

- * Com corte de metal duro colocar o parafuso de ajuste axial em contato com a guia da broca insertada.
- * Deixar um espaço entre o fio e a guia da broca para prevenir quebras por impacto acidental.
- * O parafuso axial também se usa para prolongar a vida das brocas depois de reafiar-lhas.

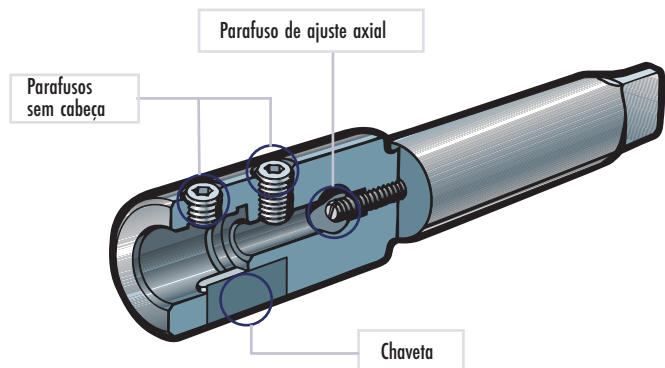

DIMENSÕES DE GUIA, PORTA E BROCA

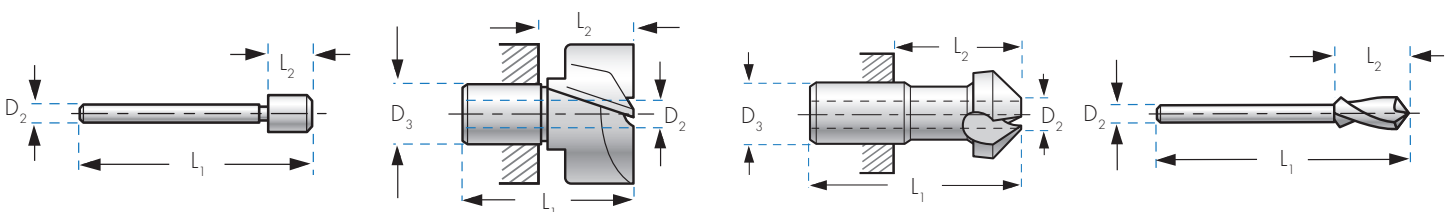

GUIA				PORTA				ESCAREADOR				BROCA					
	D ₂ mm	L ₁ mm	L ₂ mm		D ₃ mm	D ₂ mm	L ₁ mm	L ₂ mm		D ₃ mm	D ₂ mm	L ₁ mm	L ₂ mm		D ₂ mm	L ₁ mm	L ₂ mm
AGP	4	64	9	APAV-MD-PQ	10	4	40	22	AVC	10	4	40	22	ABP	4	70	15
BGP	6	80	14	BPAV-MD-PQ	14	6	48	28	BVC	14	6	48	28	BBP	6	95	25
CGP	10	110	20	CPAV-MD-PQ	22	10	61	33	CVC	22	10	61	33	CBP	10	125	30

**ESCREADORES COM ELEMENTOS INTERCAMBIÁVEIS
PARA PARAFUSOS COM CABEÇA "ALLEN" E CÓNICA**

**SERIE
A**

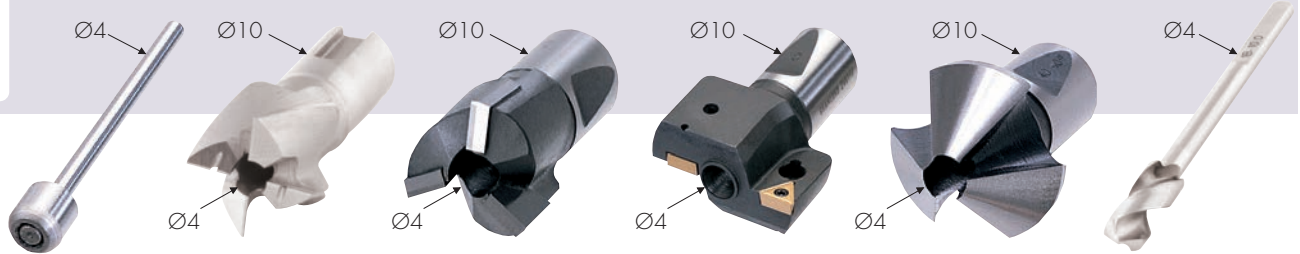

GUIA

PORTA

PORTA

PASTILHA INTERCAMBIÁVEL

ESCREADOR

BROCA

AGP

APAV

APAVMD

APAVPQ

AVC

ABP

AGP	APAV		APAVMD		APAVPQ		AVC		ABP		
	€	HSS €	MD €	Pastilha não incluída	PMD €	90° HSS €	HSS €	HSS €			
									ABP0430	78,48	
									ABP0450	78,48	
									ABP0500	78,48	
									ABP0530	78,48	
									ABP0550	78,48	
AGP0400	45,28								ABP0600	92,24	
AGP0450	54,00	APAV0700	138,20					AVC0800	180,12	ABP0640	92,24
AGP0550	54,00	APAV0800	136,53						180,12	ABP0650	92,24
AGP0600	54,00	APAV0900	136,53								
AGP0650	54,00	APAV1000	132,16	APAVMD1000	388,14			AVC1000	180,12	ABP0660	92,24
AGP0640	54,00										
AGP0660	54,00	APAV1100	136,53	APAVMD1100	388,14			AVC1200	182,81	ABP0700	92,24
AGP0500	54,00										
		APAV1150	150,96								
		APAV1200	138,20	APAVMD1200	388,14			AVC1150	176,78		
		APAV1250	153,30					AVC1240	184,93		
		APAV1300	150,63	APAVMD1300	388,14						
		APAV1350	173,43					AVC1350	184,93		
		APAV1400	150,63	APAVMD1400	391,81			AVC1400	198,25		
		APAV1450	173,77								
AGP0840	54,69										
AGP0900	54,69	APAV1500	152,30	APAVMD1500	396,17			AVC1500	199,91		
AGP0680	54,00										
AGP0700	54,00	APAV1600	161,00	APAVMD1600	405,24			AVC1600	200,93		
AGP0750	54,00	APAV1700	164,07	APAVMD1700	413,97			AVC1650	195,58		
AGP0800	54,69	APAV1800	168,38	APAVMD1800	422,66	APAVPQ1800	882,90				
AGP0850	54,69	APAV1900	179,15	APAVMD1900	441,78						
AGP0900	54,69	APAV2000	185,51	APAVMD2000	451,19	APAVPQ2000	989,59				
AGP0950	54,69	APAV2100	202,29	APAVMD2100	472,63						
AGP1000	54,69										
AGP1050	54,69										
AGP1100	54,69										
AGP1150	54,69										

ADAPTADORES



	D1 mm	D2 mm	L1 mm	L2 mm	CM Ømm	APH
						€
APHCM1	18	10	110	48	CM1	323,70
APHCM2	18	10	132	57	CM2	317,67
APH-10	18	10	92	42	Ø10	302,57

PASTILHAS DE REPOR

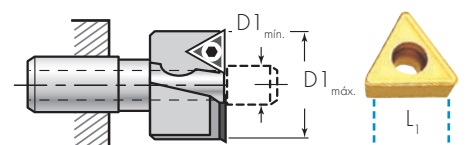

PPQ	L1 mm	D1 min. Ømm	D1 max. Ømm	PPQ
				€
PPQ07	7	18	20	33,55

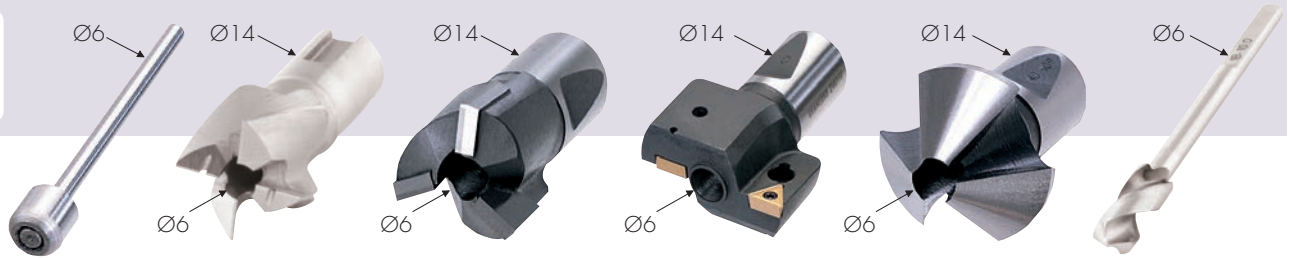
**ESCAREADORES COM ELEMENTOS INTERCAMBIÁVEIS
 PARA PARAFUSOS COM CABEÇA "ALLEN" E CÓNICA**
**SERIE
 B**

GUIA		PORTA		PORTA		PASTILHA INTERCAMBIÁVEL		ESCAREADOR		BROCA	
BGP		BPAV		BPAVMD		BPAVPQ		BVC		BBP	
€	HSS	€	MD	€	Pastilha não incluída	€	90°	€	€	€	
		BPAV1300	152,97	BPAVMD1300	413,97						
		BPAV1350	172,74								
		BPAV1400	152,97	BPAVMD1400	413,97						
		BPAV1450	172,74								BBP0800 109,70
BGP0840	50,99										
BGP0900	50,99	BPAV1500	152,97	BPAVMD1500	413,97			BVC15	189,87	BBP0900	109,70
BGP0680	50,99										
BGP0800	50,99										
BGP1000	50,99	BPAV1550	175,10								
BGP1150	54,00	BPAV1600	161,37	BPAVMD1600	429,37					BBP0840	109,70
BGP1250	56,02	BPAV1650	187,17							BBP0850	109,70
BGP1350	61,72	BPAV1700	168,05	BPAVMD1700	429,37					BBP0950	109,70
BGP1450	62,38	BPAV1750	188,50							BBP1000	125,12
		BPAV1900	193,89	BPAVMD1900	433,09					BBP1050	125,12
BGP1050	54,00										
BGP1100	54,00	BPAV1800	174,44	BPAVMD1800	433,09			BVC20	214,68	BBP1100	125,12
BGP0850	50,99										
BGP1300	61,72										
BGP1400	62,38	BPAV2000	193,89	BPAVMD2000	446,49	BPAVPQ2000	883,64	BVC25	223,43		
BGP1020	54,00										
BGP1500	62,38										
BGP1550	62,38	BPAV2400	229,13	BPAVMD2400	474,34	BPAVPQ2400	884,78	BVC28	259,97		
BGP1200	54,00										
BGP1700	62,38										
BGP1750	62,38	BPAV2600	244,87	BPAVMD2600	477,02	BPAVPQ2600	1.014,46	BVC30	265,69		
BGP1400	62,38										
BGP1900	63,73										
BGP2000	79,50	BPAV3000	330,75	BPAVMD3000	520,30	BPAVPQ3000	1.014,46				
		BPAV3400	391,12	BPAVMD3400	600,08	BPAVPQ3400	1.170,92				

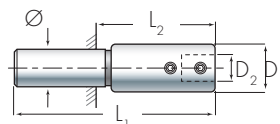
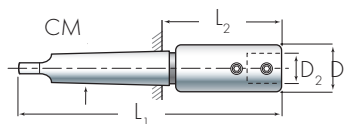
ADAPTADORES

	D1	D2	L1	L2	CM	BPH	€
	mm	mm	mm	mm	Ømm		
BPHCM1	24	14	123	62	CM1		358,95
BPHCM2	24	14	137	62	CM2		327,74
BPHCM3	24	14	160	66	CM3		358,95
BPH-12	24	14	120	55	Ø12		324,03

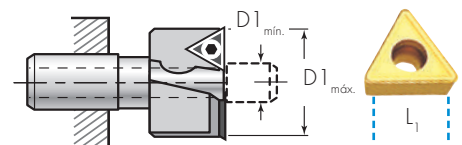
PASTILHAS DE REPOR

	L1	D1 min.	D1 máx.	PPQ	€
	mm	Ømm	Ømm		
PPQ07	7	20	25		33,55
PPQ10	10	26	33		30,20
PPQ12	12	34	36		30,20

**ESCREADORES COM ELEMENTOS INTERCAMBIÁVEIS
PARA PARAFUSOS COM CABEÇA "ALLEN" E CÔNICA**

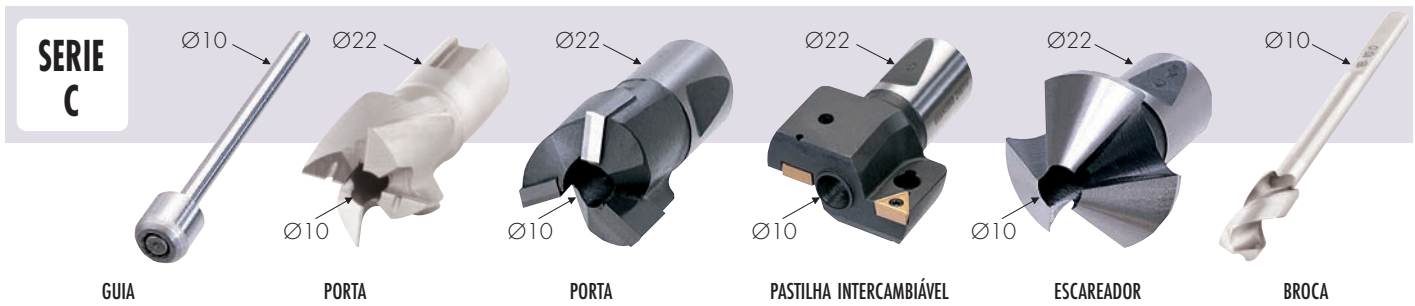

CGP		CPAV		CPAVMD		CPAVPQ		CVC		CBP	
€	HSS €	MD €	Pastilha não incluída	PMD €	90° HSS €	HSS €					
CGP1200	58,03	CPAV2300	277,75	CPAVMD2300	517,59						
CGP1250	58,03	CPAV2400	281,42	CPAVMD2400	512,22						
CGP1300	58,03	CPAV2500	304,27	CPAVMD2500	513,24						
CGP1350	58,03	CPAV2600	310,30	CPAVMD2600	527,33						
CGP1400	68,10	CPAV2700	314,65								
CGP1450	68,10	CPAV2800	320,69	CPAVMD2800	532,36					CBP1700	274,08
CGP1500	68,10	CPAV2900	328,40							CBP1800	308,94
CGP1600	68,10	CPAV3100	356,92							CBP1900	324,03
CGP1650	68,10	CPAV3200	368,66	CPAVMD3200	581,33					CBP2100	351,23
CGP1700	68,10	CPAV3300	372,00							CBP2300	422,66
CGP1900	68,10										
CGP2000	68,10	CPAV3000	332,75	CPAVMD3000	587,04			CVC35	387,44	CBP2000	351,23
CGP1550	68,10										
CGP2100	75,82										
CGP2200	75,82	CPAV3400	375,73	CPAVMD3400	623,94	CPAVPQ3400	1.210,86	CVC37	409,92	CBP2200	391,81
CGP1750	68,10										
CGP1850	68,10	CPAV3500	393,49								
CGP2300	75,82										
CGP2400	75,82	CPAV3600	398,19	CPAVMD3600	641,04	CPAVPQ3600	1.210,86	CVC37	409,92	CBP2400	431,75
CGP1950	68,10										
CGP2500	75,82										
CGP2600	93,24	CPAV4000	462,26	CPAVMD4000	710,14	CPAVPQ4000	1.238,76	CVC40	435,75		
CGP2100	75,82										
CGP2200	75,82	CPAV4500	570,27			CPAVPQ4500	1.261,38				
CGP2050	75,82	CPAV5000	828,23			CPAVPQ5000	1.475,89				
		CPAV5500	872,50			CPAVPQ5500	1.743,16				
		CPAV6000	919,46			CPAVPQ6000	1.743,16				
		CPAV6500	1.034,20			CPAVPQ6500	1.993,47				

ADAPTADORES



	D1 mm	D2 mm	L1 mm	L2 mm	CM Ømm	CPH €
CPHCM2	36	22	160	85	CM2	472,63
CPHCM3	36	22	180	87	CM3	446,49
CPHCM4	36	22	206	89	CM4	500,49
CPHCM5	36	22	240	91	CM5	1.101,30
CPH-12	36	22	140	71	Ø20	324,03

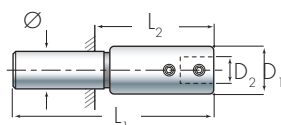
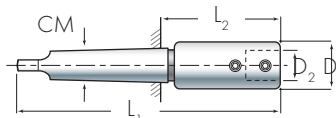

PASTILHAS DE REPOR

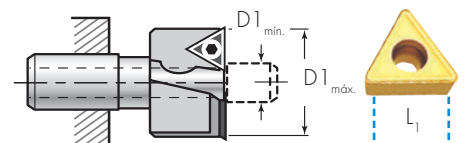

	L1 mm	D1 min. Ømm	D1 max. Ømm	PPQ €
PPQ12	12	34	45	30,20
PPQ17	17	<46		46,80

ESTOJOS DE ESCAREADORES
ESTOJOS DE BROCAS ESCAREADORAS PARA TUBO E CHAPA HSS E HSSCO
HSS

(Brocas Ref. AV30)

AV30BM0 AV30BM1 AV30BM2

REFERÊNCIA	AV30BM012	
Nº BROCAS	3	
QUALIDADE	HSS	
CONTEÚDO	AV30BM0 - AV30BM1 - AV30BM2 (3-14mm) (6-20mm) (16-30mm)	
P.V.P. €	HSS	115,47
€	HSS TiN	219,14

HSSCo

(Brocas Ref. AVC30)

AVC30BM0 AVC30BM1 AVC30BM2

REFERÊNCIA	AVC30BM012	
Nº BROCAS	3	
QUALIDADE	HSSCo	
CONTEÚDO	AVC30BM0 - AVC30BM1 - AVC30BM2 (3-14mm) (6-20mm) (16-30mm)	
P.V.P. €	HSS Co	166,34
€	HSS Co TiN	234,33

ESTOJO DE BROCAS ESCALONADAS HELICOIDAIS HSS
HSS

(Brocas Ref. AV42)

AV42BM2 AV42BM3 AV42BM4

REFERÊNCIA	AV42BM234	
Nº BROCAS	3	
QUALIDADE	HSS	
CONTEÚDO	AV42BM2 - AV42BM3 - AV42BM4	
P.V.P. €	HSS	317,53
€	HSS TiN	397,93



ESTOJOS DE ESCAREADORES

ESTOJOS DE BROCAS ESCALONADAS COM CANAIS RETOS HSS

HSS



AV40BM2 AV40BM3 AV40BM4 AV40BM5 AV40BM13



(Brocas Ref. AV40)

REFERÊNCIA	PAV40BM234	PAV40BM235	PAV40BM2313
Nº BROCAS	3	3	3
CONTEÚDO	AV40BM2 - AV40BM3 - AV40BM4 (4-12mm) (4-20mm) (4-30mm)	AV40BM2 - AV40BM3 - AV40BM5 (4-12mm) (4-20mm) (6-38mm)	AV40BM2 - AV40BM3 - AV40BM13 (4-12mm) (4-20mm) (6-40mm)
P.V.P. €	186,80	232,75	286,06
€	HSS TiN 305,67	HSS TiN 347,55	HSS TiN 416,77



(Brocas Ref. AV40)

REFERÊNCIA	AV40BM234	AV40BM22122
Nº BROCAS	3	3
CONTEÚDO	AV40BM2 - AV40BM3 - AV40BM4 (4-12mm) (4-20mm) (4-30mm)	AV40BM2 - AV40BM21 - AV40BM22 (4-12mm) (7+10-20mm) (10+20-30mm)
P.V.P. €	186,80	278,70
€	HSS TiN 305,67	HSS TiN 403,89

(Brocas Ref. AVC40)

REFERÊNCIA	AVC40BM234
Nº BROCAS	3
CONTEÚDO	AVC40BM2 - AVC40BM3 - AVC40BM4 (4-12mm) (4-20mm) (4-30mm)
P.V.P. €	HSS Co 291,82
€	HSS Co TiN 402,89

ESTOJOS DE ESCAREADORES

HSS



90°

DIN
335C

(Escareadores Ref. AV6)

REFERÊNCIA	AV6CM1	AV6CM2	AV6CM3	PAV6CM2
Nº BROCAS	6	6	7	6
CONTEÚDO	Ø 6 - 8 - 10 - 11,5 - 15 - 19 mm	Ø 6,3 - 8,3 - 10,4 - 12,4 - 16,5 - 20,5 mm	Ø 6,3 - 8,3 - 10,4 - 12,4 - 16,5 - 20,5 - 25 mm	Ø 6,3 - 8,3 - 10,4 - 12,4 - 16,5 - 20,5 mm
P.V.P. €	154,90	135,69	228,38	135,69

HSSCo



90°

DIN
335C

(Escareadores Ref. AV7)

REFERÊNCIA	AV7CM1	AV7CM2	AV7CM3	PAV7CM2
Nº BROCAS	6	6	7	6
CONTEÚDO	Ø 6 - 8 - 10 - 11,5 - 15 - 19 mm	Ø 6,3 - 8,3 - 10,4 - 12,4 - 16,5 - 20,5 mm	Ø 6,3 - 8,3 - 10,4 - 12,4 - 16,5 - 20,5 - 25 mm	Ø 6,3 - 8,3 - 10,4 - 12,4 - 16,5 - 20,5 mm
P.V.P. €	162,45	162,04	248,65	162,04

HSS

TiN



90°

DIN
335C

(Escareadores Ref. AV16)

REFERÊNCIA	AV16CM1	AV16CM2	AV16CM3
Nº BROCAS	6	6	7
CONTEÚDO	Ø 6 - 8 - 10 - 11,5 - 15 - 19 mm	Ø 6,3 - 8,3 - 10,4 - 12,4 - 16,5 - 20,5 mm	Ø 6,3 - 8,3 - 10,4 - 12,4 - 16,5 - 20,5 - 25 mm
P.V.P. €	282,86	288,76	403,03

HSS



60°

DIN
334C

(Escareadores Ref. AV8)

REFERÊNCIA	AV8CM2	AV8CM3
Nº BROCAS	6	7
CONTEÚDO	Ø 6,3 - 8 - 10 - 12,5 - 16 - 20 mm	Ø 6,3 - 8 - 10 - 12,5 - 16 - 20 - 25 mm
P.V.P. €	211,13	272,95

* Outros estojos, AV99, etc., sob demanda.

ESTOJOS DE ESCAREADORES

HSS  **NORMA CELESA**



(Escareadores Ref. AV9)

REFERÊNCIA	AV9CM1	AV9CM5
Nº BROCAS	6	7
CONTEÚDO	Ø 6,3 - 8,3 - 10,4 - 12,4 - 16,5 - 20,5 mm	Ø 6,3 - 8,3 - 10,4 - 12,4 - 16,5 - 20,5 - 25 mm
P.V.P. €	215,94	279,44



HSS  **NORMA CELESA**



(Escareadores Ref. AV10)

REFERÊNCIA	AV10CM1	AV10CM6
Nº BROCAS	6	7
CONTEÚDO	Ø 6,3 - 8,3 - 10,4 - 12,4 - 16,5 - 20,5 mm	Ø 6,3 - 8,3 - 10,4 - 12,4 - 16,5 - 20,5 - 25 mm
P.V.P. €	242,94	300,72



* Outros estojos, AV99, etc., sob demanda.

ESTOJOS DE ESCAREADORES PARA REBARBAR COM FURO DE 90º HSS E HSSCO

 **90°**

HSS

(Escareadores Ref. AV1)

REFERÊNCIA	AV1S2*
Nº BROCAS	5
CONTEÚDO	Ø 10 - 14 - 20 - 27 - 30 mm
P.V.P. €	305,53*

HSSCo

(Escareadores Ref. AV2)

REFERÊNCIA	AV2S2*
Nº BROCAS	5
CONTEÚDO	Ø 10 - 14 - 20 - 27 - 30 mm
P.V.P. €	384,57*
€	HSS Co TiN
	513,48*

*Até o fim das existências.

ESTOJOS DE ESCAREADORES PARA PARAFUSOS "ALLEN" AJUSTE FINO, MEIO E FURO ROSCADO

HSS **DIN 373**

FINO

MEIO

FURO ROSCADO

(Escareadores Ref. AV2M)

(Escareadores Ref. AV2MM)

(Escareadores Ref. AV2GM)

REFERÊNCIA	AV2M3-10	AV2M3-10M	AV2M3-10G
Nº BROCAS	6		
CONTEÚDO	M3 - M4 - M5 - M6 - M8 - M10		
P.V.P. €	182,38	197,45	197,45

REFERÊNCIA	AV2M3-12	AV2M3-12M	AV2M3-12G
Nº BROCAS	7		
CONTEÚDO	M3 - M4 - M5 - M6 - M8 - M10 - M12		
P.V.P. €	234,23	253,56	253,56



Ref. AV2M3-10

REBARBADOR DE PRECISÃO

OS REBARBADORES BLUE-MASTER

Os rebarbadores BLUE-MASTER são utilizados para eliminar as limanhas acumuladas nas bordas e arestas de peças fabricadas em metal, plástico ou madeira.

O sistema completa-se juntando os três componentes indicados: LÂMINA + PORTA-LÂMINAS + CABO UNIVERSAL

O cabo pode ser utilizado com todos os grupos de lâminas, trocando o porta-lâminas para cada um deles.

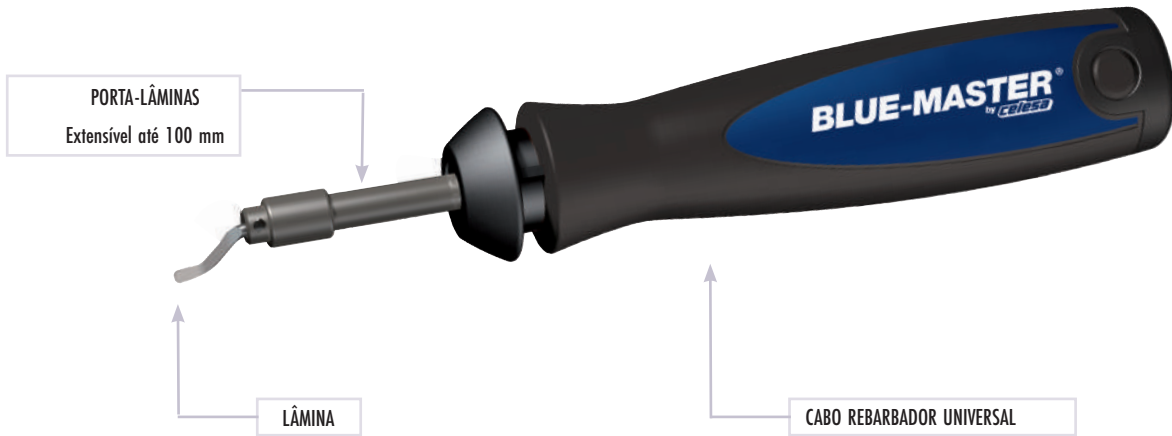

CONJUNTO B

JRB1

Conteúdo B:

Ref. RB10



Ref. RBB1



Ref. RB20



Ref. RBB

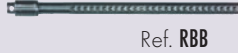

Blister: 32,65 €

CONJUNTO C

JRB2

Conteúdo C:

Ref. RC42

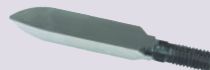

Ref. RBB1



Ref. RBC

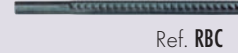

Blister: 59,46 €

CONJUNTO D

JRB3

Conteúdo D:

Ref. RD80MD



Ref. RBB1



Ref. RBD

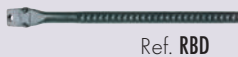

Blister: 93,73 €

CONJUNTO E

JRB4

Conteúdo E:

Ref. RE10



Ref. RBB1



Ref. RE20

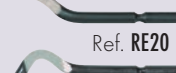

Ref. RBE



Ref. RE30

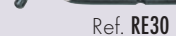

Blister: 36,36 €



REBARBADOR DE PRECISÃO

GRUPO B

PORTA-LÂMINAS GRUPO B

Ø2,6mm



Para lâminas rebarbadoras GRUPO B.

RBB

11,46 €

LÂMINAS GRUPO B

Lâmina rebarbadora.
Serie curta: Aço, alumínio, fundição.



RB10*

Blister 10 U.: 2,12 €/U.



Lâmina de punção de metal duro.

RB50*

Blister 1 U.: 37,72 €

Lâmina rebarbadora bidirecional.
Serie curta: latão, fundição.



RB20

Blister 10 U.: 2,12 €/U.



Lâmina rebarbadora para parte posterior duma furação de até 20mm de profundidade.

RB60*

Blister 10 U.: 5,01 €/Ud

Lâmina rebarbadora dupla aresta furos de 4mm de profundidade.



RB30

Blister 10 U.: 2,12 €/Ud



Lâmina rebarbadora de arestas exteriores.

RB70MD*

Blister 1 U.: 42,91 €

*Até o fim das existências.

GRUPO C

PORTA-LÂMINAS GRUPO C



Para lâminas rebarbadoras GRUPO C.

RBC

Blister 1 U.: 11,46 €

LÂMINAS GRUPO C



Lâmina raspador largo 4 x 20 mm.

RC40*

Blister 1 U.: 23,36 €



Lâmina raspador largo 8 x 30 mm.

RC42*

Blister 1 U.: 29,06 €

*Até o fim das existências.

GRUPO D

PORTA-LÂMINAS GRUPO D



Para lâminas rebarbadoras GRUPO D.

RBD

Blister 1 U.: 11,46 €

LÂMINAS GRUPO D



Lâmina rebarbadora de metal duro em "V" fêmea cantos de até 3 mm.

RD80MD*

Blister 1 U.: 61,07 €



Lâmina rebarbadora de metal duro em "V" fêmea cantos de até 8 mm.

RD82MD*

Blister 1 U.: 95,74 €

*Até o fim das existências.

CABO REBARBADOR UNIVERSAL

Utilizações gerais.
Válido para porta-lâminas:
Ref. RBB / RBC / RBD / RBE / RBF



RBB1
Blister 1 ud.: **15,06 €**

REBARBADOR DE PRECISÃO

GRUPO E

PORTA- LÂMINAS GRUPO E



Para lâminas rebarbadoras Grupo E.

RBE
Blister 1 ud.: **11,46 €**

LÂMINAS GRUPO E



Lâmina rebarbadora para interiores e exteriores.
Serie longa: Aço, alumínio, plástico.

RE10
Blister 10 ud.: **2,59 €/Ud**



Lâmina rebarbadora para cantos retos: chaveteros, ...

RE35
Blister 10 ud.: **2,78 €/Ud**



Lâmina rebarbadora bidirecional: latão, fundição.

RE20
Blister 10 ud.: **2,59 €/Ud**



Lâmina rebarbadora fechada dupla aresta para furos de 4mm de profundidade.

RE30
Blister 10 ud.: **2,59 €/Ud**



Lâmina rebarbadora para parte posterior duma furação de até 20mm de profundidade.

RE60*
Blister 5 ud.: **3,64 €/Ud**

*Até o fim das existências.

GRUPO F

PORTA- LÂMINAS GRUPO F



Para lâminas rebarbadoras Grupo F.

RBF
Blister 1 ud.: **11,46 €**

LÂMINAS GRUPO F (Rosca M05 x 0,80)



Lâmina escareadora HSS Ø 12 mm.

RF12
Blister 1 ud.: **25,78 €**

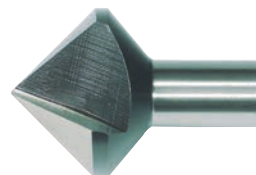

Lâmina escareadora HSS Ø 30 mm.

RF30
Blister 1 ud.: **86,14 €**



Lâmina escareadora HSS Ø 20 mm.

RF20
Blister 1 ud.: **49,83 €**