

SVASATORI

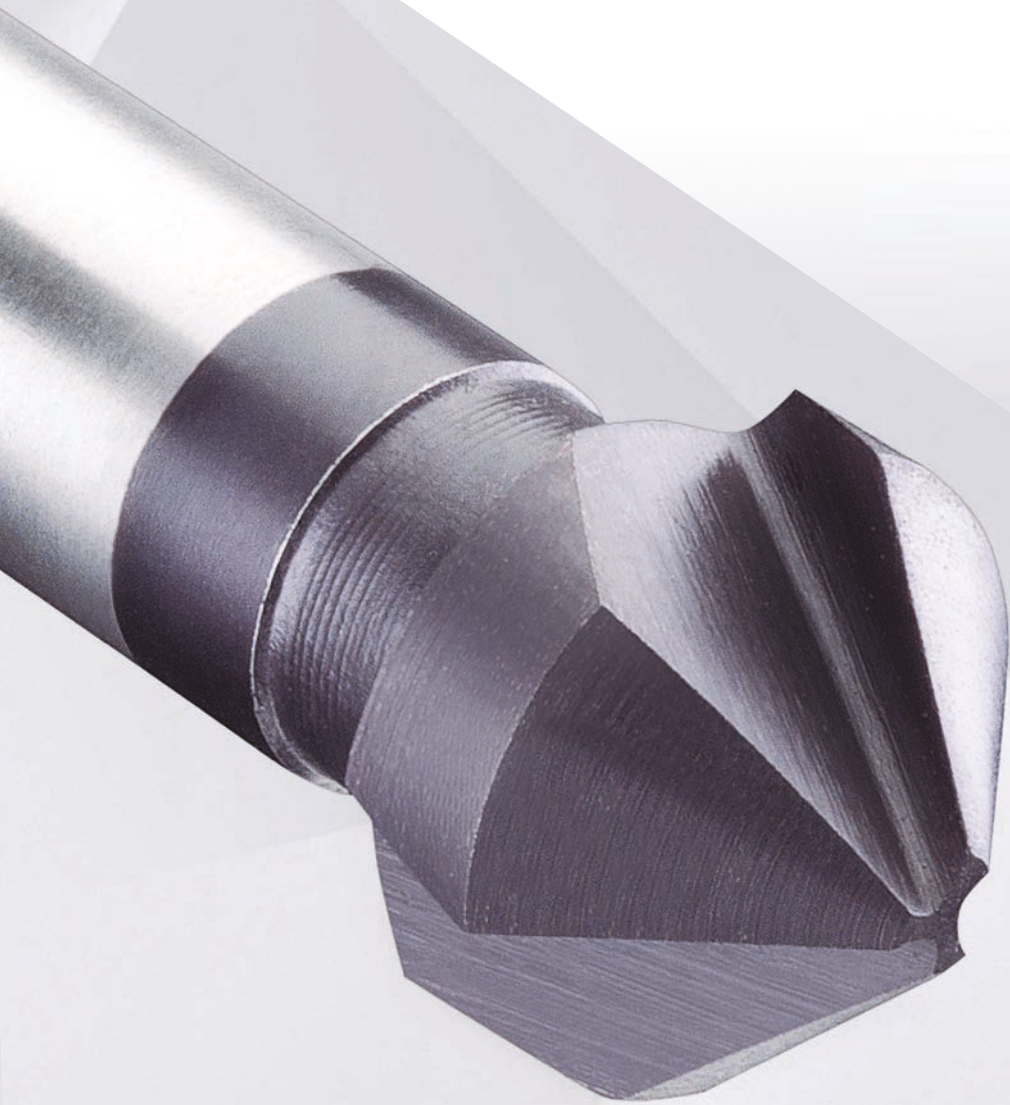

BLUE-MASTER[®]
by CELESA

CUTTING TECHNOLOGIES

PUNTE A SVASARE PER TUBI E LAMIERE HSS E HSSCo

Svasatori

Rosa

HSS

Ref. AV30

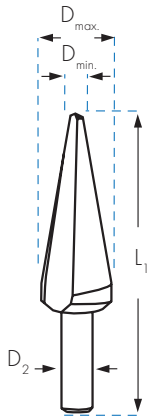

118°

BM0 BM1 BM5 BM3 BM4 BM6

AV30

	D min. mm	D max. mm	D ₂ mm	L ₁ mm	HSS	TiN
					€	€
AV30BM0B	3,0	14,0	6,0	58	17,50	40,79
AV30BM8B	3,0	22,5	8,0	85	53,24	96,48
AV30BM5B	3,0	31,0	10,0	102	76,50	129,77
AV30BM9B	5,0	25,4	10,0	87	64,16	122,59
AV30BM1B	6,0	20,0	8,0	63	28,80	59,53
AV30BM2B	16,0	30,0	10,0	79	50,93	98,50
AV30BM3B	26,0	40,0	13,0	86	105,36	180,48
AV30BM4	36,0	50,0	13,0	89	169,74	261,85
AV30BM6	40,0	61,0	13,0	98	281,21	437,94

* Le referenze che terminano in B si somministrano in blister.

HSSCo

Ref. AVC30

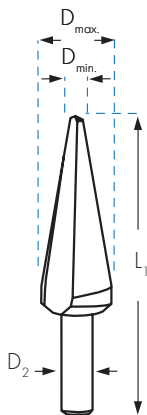

118°

BM0 BM1 BM2 BM3

AVC30

	D min. mm	D max. mm	D ₂ mm	L ₁ mm	HSSCo	TiN
					€	€
AVC30BM0B	3,0	14,0	6,0	58	37,78	49,34
AVC30BM1B	6,0	20,0	8,0	63	50,10	76,08
AVC30BM2B	16,0	30,0	10,0	79	82,65	110,21
AVC30BM3B	26,0	40,0	13,0	86	215,06	232,09

PUNTE A SVASARE PER LAMIERA HSS CARATTERISTICHE SPECIALI

HSS

Ref. AG

Punta a svasare per il taglio di tubi e lamiera in acciaio, leghe leggere e materie plastiche. Indicato fino a 5mm di profondità.

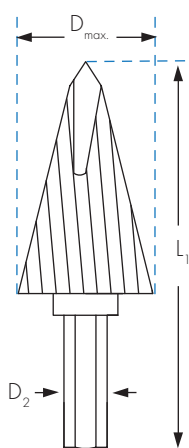

FRESA CONICA ALLARGAFORI PER LAMIERE, SPECIALE PER MECCANICI, ELETTRAUTO, CARROZZIERI

	D _{max.} mm	D ₂ mm	L ₁ mm	N° denti	AG HSS €
AG2500	25,0	8,0	72	20	27,59
AG3200	32,0	10,0	81	30	41,43
AG4500	45,0	10,0	94	36	68,43

HSS

Ref. AV31



COLLARE DI ARRESTO PROFONDITÀ

	D _{min.} mm	D _{max.} mm	D ₂ mm	L ₁ mm	AV31 HSS €	TiN €
AV31BM0B	3,0	7,8	6,0	48	32,71	49,51
AV31BM1B	3,0	10,2	6,0	52	42,95	67,35
AV31BM2B	3,0	11,8	6,0	56	47,81	84,47

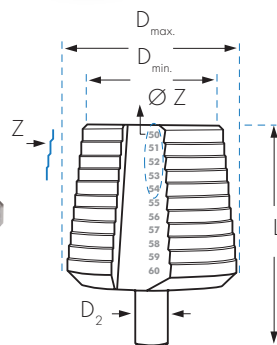
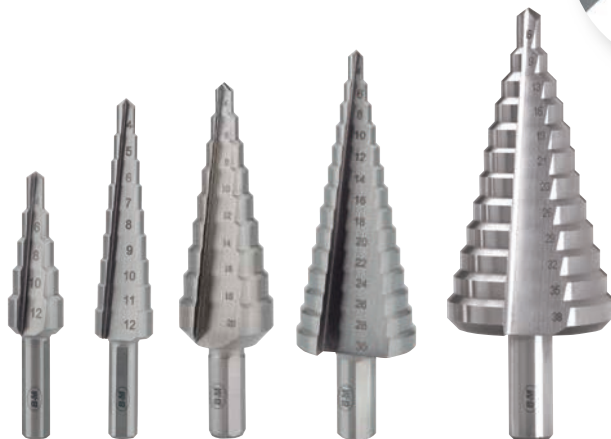
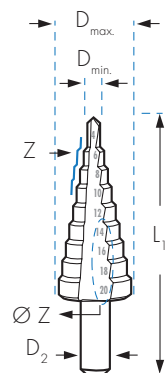
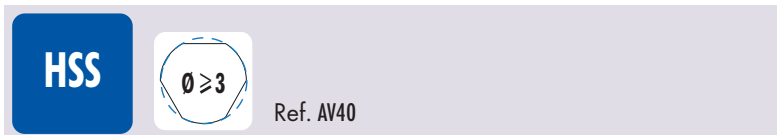
PUNTE A GRADINO A CANALI DRITTI HSS

BM1

BM2

BM3

BM4

BM5

Ref. AV40BM25 / 26 / 27 / 28 / 29

AV40

	D min. mm	D max. mm	D ₂ mm	L ₁ mm	Z	Ø Z mm minore-maggiore	HSS €	TiN €
AV40BM1B	4,0	12,0	6,0	65	5	4-6-8-10-12	24,14	60,88
AV40BM2B	4,0	12,0	6,0	65	9	4-5-6-7-8-9-10-11-12	25,74	65,52
AV40BM3B	4,0	20,0	8,0	69	9	4-6-8-10-12-14-16-18-20	35,01	83,65
AV40BM4B	4,0	30,0	10,0	96	14	4-6-8-10-12-14-16-18-20-22-24-26-28-30	74,03	126,27
AV40BM14	4,0	39,0	10,0	107	13	4-6-9-12-15-18-21-24-27-30-33-36-39	206,55	325,01
AV40BM16B	5,0	28,0	10,0	69	7	5-8-8-11,8-15,3-19-24,5-28	95,81	150,77
AV40BM35B	5,0	35,0	13,0	80	13	5-7-10-12-15-17-20-22-25-27-30-32-35	99,88	144,56
AV40BM11B	6,0	25,0	10,0	65	7	6-9-12-16-20-22,50-25	78,24	112,03
AV40BM10B	6,0	26,7	10,0	75	8	6-9-11,40-14-17,25-19-21,25-26,75	152,32	239,70
AV40BM17B	6,0	30,5	10,0	80	9	6-9-12,5-15,2-18,6-20,4-22,5-28,3-30,5	146,33	241,77
AV40BM12B	6,0	32,0	10,0	75	9	6-9-12-16-20-22,5-25-28,5-32	110,41	150,96
AV40BM18B	6,0	37,0	10,0	100	12	6-9-12,5-15,2-18,6-20,4-22,5-26-28,3-30,5-34-37	155,54	278,57
AV40BM5B	6,0	38,0	10,0	96	12	6-9-13-16-19-21-23-26-29-32-35-38	125,97	186,11
AV40BM13	6,0	40,0	13,0	105	16	6-11-17-23-29-30-31-32-33-34-35-36-37-38-39-40	215,98	265,37
AV40BM15B	6,5	32,5	10,0	79	9	6,50-8,50-10,50-12,50-16,50-20,50-25,50-29-32,50	127,84	179,16
AV40BM20	6,5	40,5	10,0	96	11	6,50-8,50-10,50-12,50-16,50-20,50-25,50-29-32,50-36,50-40,50	200,43	315,40
AV40BM21B	7,0	20,0	10,0	80	12	7-10-11-12-13-14-15-16-17-18-19-20	80,19	126,20
AV40BM22B	10,0	30,0	13,0	83	12	10-20-21-22-23-24-25-26-27-28-29-30	125,53	196,93
AV40BM25B	12,0	20,0	8,0	66	9	12-13-14-15-16-17-18-19-20	79,56	106,48
AV40BM26B	20,0	30,0	10,0	78	11	20-21-22-23-24-25-26-27-28-29-30	105,00	163,48
AV40BM27	30,0	40,0	10,0	78	11	30-31-32-33-34-35-36-37-38-39-40	146,98	209,15
AV40BM28	40,0	50,0	13,0	85	11	40-41-42-43-44-45-46-47-48-49-50	210,11	323,69
AV40BM29	50,0	60,0	13,0	85	11	50-51-52-53-54-55-56-57-58-59-60	292,62	363,48

PER PASSARE TUBATURE FILETTATURA GAS

AV40BM6B	6,0	32,0	10,0	75	8	6-9-11,20(1/8)-14,50(1/4)-18,20(3/8)-22,30(1/2)-27,90(3/4)-32	114,57	157,02
----------	-----	------	------	----	---	---	--------	--------

PER RIVETTI CIECHI M3 - M4 - M5 - M6 E M7

AV40BM7B	4,8	10,6	6,0	54	5	4,80-6,40-7,20-9,60-10,65	37,34	53,25
----------	-----	------	-----	----	---	---------------------------	-------	-------

PER CONDUZIONI ELETTRICHE (VECCHIA E NUOVA NORMA)

AV40PG21B	PG7	PG21	13,0	70	11	6,5-8,5-10,5-12,5(PG7)-15,2(PG9)-18,6(PG11) 20,4(PG13,5)-22,5(PG16)-25,5-18,3(PG21)-30,5	126,14	178,34
AV40PG29B	PG7	PG29	13,0	81	14	6,5-9-11-12,5(PG7)-15,2(PG9)-18,6(PG11)-20,4(PG13,5) 22,5(PG16)-26-28,3(PG21)-30,5-33-35-37(PG29)	162,95	228,60
AV40BM8B	8,5	32,5	10,0	70	12	8,5-10,5-12,5-14,5-16,5-18,5-20,5-23,5-25,5 28-30,5-32,5	95,63	147,03
AV40BM9B	8,5	40,5	12,0	84	16	8,5-10,5-12,5-14,5-16,5-18,5-20,5-23,5-25,5 28-30,5-32,5-34,5-36,5-38,5-40,5	140,26	219,55

PUNTE A GRADINO A CANALI DRITTI HSSCo

HSSCo **INOX** Ref. AVC40

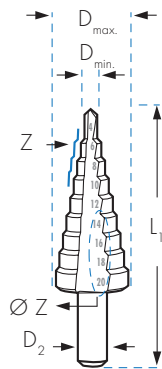

BM1 BM2 BM3 BM4 BM18

								AVC40	
	D min. mm	D max. mm	D2 mm	L1 mm	Z	Ø Z mm minore-maggiore	HSSCo €	TiN €	
AVC40BM1B	4,0	12,0	6,0	65	5	4-6-8-10-12	50,14	81,30	
AVC40BM2B	4,0	12,0	6,0	65	9	4-5-6-7-8-9-10-11-12	53,45	88,18	
AVC40BM3B	4,0	20,0	8,0	69	9	4-6-8-10-12-14-16-18-20	68,50	111,06	
AVC40BM4B	4,0	30,0	10,0	96	14	4-6-8-10-12-14-16-18-20-22-24-26-28-30	124,76	202,27	
AVC40BM18B	6,0	37,0	10,0	100	12	6-9-12,5-15,2-18,6-20,4-22,5-26-28,3-30,5-34-37	226,83	346,13	

PUNTE A GRADINO A CANALI ELICOIDALI HSS

HSS Ref. AV42

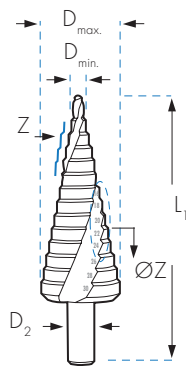

BM2 BM3 BM4

								AV42	
	D min. mm	D max. mm	D2 mm	L1 mm	Z	Ø Z mm minore-maggiore	HSS €	TiN €	
AV42BM1B	4,0	12,0	6,0	65	5	4-6-8-10-12	48,14	69,78	
AV42BM2B	4,0	12,0	6,0	68	9	4-5-6-7-8-9-10-11-12	51,30	74,36	
AV42BM3B	4,0	20,0	8,0	69	9	4-6-8-10-12-14-16-18-20	65,76	95,33	
AV42BM4B	4,0	30,0	10,0	96	14	4-6-8-10-12-14-16-18-20-22-24-26-28-30	119,75	173,60	
AV42BM5B	6,0	38,0	10,0	96	12	6-9-13-16-19-21-23-26-29-32-35-38	176,36	255,66	
AV42BM11B	6,0	25,0	10,0	65	7	6-9-12-16-20-22,50-25	93,87	136,08	
AV42BM12B	6,0	32,0	10,0	75	9	6-9-12-16-20-22,5-25-28,5-32	132,49	192,06	
AV42BM13	6,0	40,0	13,0	105	16	6-11-17-23-29-30-31-32-33-34-35-36-37-38-39-40	259,19	375,71	
AV42BM8B	8,5	32,5	10,0	70	12	8,5-10,5-12,5-14,5-16,5-18,5-20,5-23,5-25,5-28-30,5-32,5	114,75	166,35	
AV42BM9B	8,5	40,5	12,0	84	16	8,5-10,5-12,5-14,5-16,5-18,5-20,5-23,5-25,5-28-30,5-32,5-34,5-36,5-38,5-40,5	181,77	263,49	

PUNTE A GRADINO HSS CARATTERISTICHE SPECIALI
HSS
CODOLO ESAGONALE 1/4"

	D min. mm	D max. mm		L ₁ mm	Z	Ø Z mm minore-maggiore	AV41	
							HSS €	TiN €
AV41BM2B	4,0	12,0	1/4"	72	9	4-5-6-7-8-9-10-11-12	81,63	101,22
AV41BM3B	4,0	20,0	1/4"	81	9	4-6-8-10-12-14-16-18-20	107,90	133,85
AV41BM4B	4,0	30,0	1/4"	105	14	4-6-8-10-12-14-16-18-20-22-24-26-28-30	127,90	154,08



Ref. AV41BM2B

SERIE CORTA Massimo 2 mm di spessore

	D min. mm	D max. mm	D ₂ mm	L ₁ mm	Z	Ø Z mm minore-maggiore	AV41C	
							HSS €	TiN €
AV41CBM2B	4,0	12,0	6,0	48	9	4-5-6-7-8-9-10-11-12	66,48	89,26
AV41CBM3B	4,0	20,0	8,0	58	9	4-6-8-10-12-14-16-18-20	82,56	115,36
AV41CBM4B	4,0	30,0	10,0	72	14	4-6-8-10-12-14-16-18-20-22-24-26-28-30	134,59	207,24



Ref. AV41CBM3B

AVVITAMENTI METRICI PER CAVI

	DIN	D min. mm	D max. mm	D ₂ mm	L ₁ mm	Z	Ø Z mm minore-maggiore	AV45	
								HSS €	TiN €
AV45BM0B	60423	5,3	30,5	10,0	79	9	5,3-7-9-10,5-14,5-18,5-23,5-27-30,5	183,48	236,60
AV45BM2B	60423	5,3	38,5	10,0	96	11	5,3-7-9-10,5-14,5-18,5-23,5-27-30,5-34,5-38,5	220,63	278,77



Ref. AV45BM2B3

A GRADINO DRITTA A 3 TAGLIANTI

	D min. mm	D max. mm	D ₂ mm	L ₁ mm	Z	Ø Z mm minore-maggiore	AV43	
							HSS €	TiN €
AV43BM1B	4,0	12,0	6,0	65	9	4-5-6-7-8-9-10-11-12	80,16	104,87
AV43BM2B	4,0	20,0	8,0	75	9	4-6-8-10-12-14-16-18-20	109,89	170,26
AV43BM3B	4,0	30,0	10,0	100	14	4-6-8-10-12-14-16-18-20-22-24-26-28-30	161,56	264,24

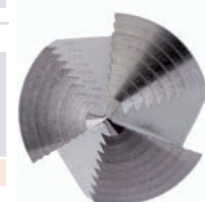

Ref. AV43BM3B

PUNTA A GRADINO CON PUNTA PILOTA INTERCAMBIABILE

	D min. mm	D max. mm	D ₂ mm	L ₁ mm	Z	Ø Z mm minore-maggiore	AV4	
							HSS €	
AV4BM3040	30,0	40,0	13,0	76	11	30-31-32-33-34-35-36-37-38-39-40	168,15	
AV4BM4050	40,0	50,0	13,0	76	11	40-41-42-43-44-45-46-47-48-49-50	242,88	
AV4BM5060	50,0	60,0	13,0	76	11	50-51-52-53-54-55-56-57-58-59-60	308,30	



Ref. AV4BM3040

PUNTA PILOTA

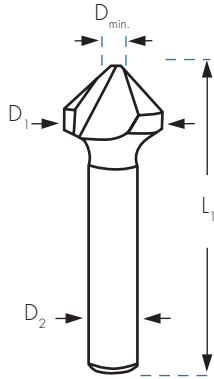

		BAV4BM
		€
BAV4BM	DESCRIZIONE	10X35mm
		10,89

SVASATORI A 3 CANALI

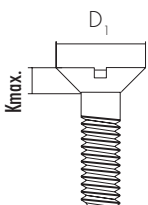

				AV6	AV16	AV37	AV7	AV38	AV99	AV6MD	AV15	
MATERIALE				HSS	HSS	HSS	HSSCo	HSSCo	HSSCo	MD	HSS	
FINITURA					TiN	TiAlN		TiAlSiN	TiAlN			
APPLICAZIONE				USO GENERALE	USO GENERALE	USO GENERALE	USO GENERALE INOX	INOX Plus	INOX Superplus Al	HARDOX 450		
D1 mm	D min. mm	D2 mm	L1 mm	€	€	€	€	€	€	€	L1 mm	€
4,30	1,3	4,0	40	11,09	22,37	32,22	19,41	37,06		55,61		
5,00	1,5	4,0	40	11,09	22,37	32,22	19,41	37,06				
5,30	1,5	4,0	40	11,09	22,37	32,22	19,41	37,06		53,54		
5,80	1,5	5,0	45	10,40	19,65	30,24	16,89	32,44				
6,00	1,5	5,0	45	10,89	19,22	30,24	16,23	32,04		54,78		
6,30	1,5	5,0	45	10,95	16,45	30,24	15,92	31,87	42,29	54,89		
7,00	1,8	6,0	50	13,68	25,67	40,34	19,41	43,09				
7,30	1,8	6,0	50	12,52	25,67	40,34	19,41	43,09				
8,00	2,0	6,0	50	12,77	25,67	40,34	19,60	43,22		60,08		
8,30	2,0	6,0	50	12,84	17,74	40,34	19,24	42,97	57,04	49,56		
9,40	2,2	6,0	50	13,96	28,97	45,21	22,69	48,92				
10,00	2,5	6,0	50	14,89	28,97	45,21	22,69	48,92		68,77		
10,40	2,5	6,0	50	15,37	22,24	45,21	23,38	48,78	64,74	55,80	112	65,17
11,50	2,8	8,0	56	15,73	30,68	48,61	25,04	53,03				
12,00	2,8	8,0	56	16,56	32,04	51,04	26,48	53,03				
12,40	2,8	8,0	56	15,76	28,61	48,61	24,75	53,50	70,38	60,02	112	77,22
13,40	2,9	8,0	56	18,43	31,70	50,21	27,00	55,54				
15,00	3,2	10,0	60	18,87	42,61	68,74	34,39	74,31		78,55		
16,50	3,2	10,0	60	19,30	35,51	68,74	33,92	73,99	98,19	77,67	120	95,77
19,00	3,5	10,0	63	27,18	53,37	83,42	50,86	90,33				
20,50	3,5	10,0	63	28,55	44,84	85,92	47,42	91,49	121,43	110,46	124	129,58
23,00	3,8	10,0	67	39,30	62,09	96,15	61,97	106,27				
25,00	3,8	10,0	67	37,55	62,97	97,16	63,08	107,66	142,89	180,24	128	156,28
28,00	4,0	12,0	71	50,28	80,05	125,73	90,09	144,70				
30,00	4,2	12,0	71	57,98	83,06	163,84	95,28	174,52				
31,00	4,2	12,0	71	58,00	86,09	175,93	95,28	170,72		203,38	133	183,07
40,00	6,5	13,0	80	130,67	131,40	206,87	139,44	213,07		353,11*		

* Codolo di 16 mm



DIMENSIONI VITE TESTA CONICA 90°

	M2	M2.5	M3	M4	M5	M6	M8	M10	M12	M14	M16	M18	M20
Kmax.	1,2	1,5	1,7	2,3	2,8	3,3	4,4	5,5	6,5	7	7,5	8	8,5
D1	4	5	6	8	10	12	16	20	24	27	30	33	36

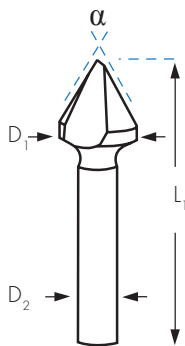
SVASATORI HSS COLODO CILINDRICO 60°, 75° E 120°
3Z

				AV8		AV9		AV10	
MATERIALE				HSS		HSS		HSS	
NORMA				DIN 334C		NORMA CELESA		NORMA CELESA	
ANGOLO DI TAGLIO				60°		75°		120°	
D ₁ mm	D _{min} mm	D ₂ mm	L ₁ mm	€		€		€	
6,30	1,5	5,0	45	AV80630	20,95	AV90630	16,14	AV100630	17,17
8,00	2,0	6,0	50	AV80800	23,04				
8,30	2,0	6,0	50			AV90830	21,99	AV100830	23,65
10,00	2,5	6,0	50	AV81000	25,12				
10,40	2,5	6,0	50			AV91040	25,97	AV101040	27,65
12,40	2,8	8,0	56	AV81250	27,84	AV91240	28,70	AV101240	33,09
16,50	3,2	10,0	60	AV81600	31,54	AV91650	36,01	AV101650	41,87
20,50	3,5	10,0	63	AV82000	42,13	AV92050	52,98	AV102050	56,51
25,00	3,8	10,0	67	AV82500	56,13	AV92500	66,80	AV102500	74,22
40,00	6,5	13,0	67	AV84000	161,20	AV94000	145,34	AV104000	171,28

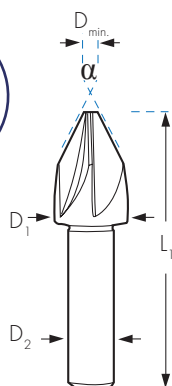
SVASATORI MULTITAGLIO CODOLO CILINDRICO 60°, 90° E 120°
5Z

				AV12		AV11		AV13				
MATERIALE				HSS		HSS		HSS				
DIN				DIN 334A		DIN 335A		DIN 347A				
ANGOLO DI TAGLIO				60°		90°		120°				
D ₁ mm	D _{min} mm	D ₂ mm	N° Z	L ₁ mm	€	L ₁ mm	€	L ₁ mm	€			
8,00	2,5	8,0	5	AV120800	48	18,31	AV110800	44	13,76	AV130800	44	18,25
12,50	2,8	8,0	5	AV121250	52	25,63	AV111250	48	20,16	AV131250	48	26,78
16,00	3,0	10,0	5	AV121600	60	42,99	AV111600	56	33,86	AV131600	56	44,94
20,00	3,5	10,0	5	AV122000	64	55,45	AV112000	60	43,61	AV132000	60	57,94
25,00	3,5	10,0	5	AV122500	69	77,62	AV112500	65	61,06	AV132500*	65	78,83

 * D₂: 12,00 mm

SVASATORI HSS E HSSCo PER SBAVARE CON FORO

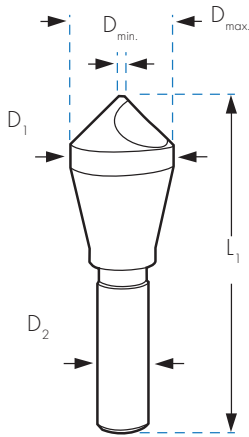

MATERIALE					AV1	AV1T	AV2	AV2T	AV1-60					
FINITURA					HSS	HSS	HSSCo	HSSCo	HSS					
ANGOLO DI TAGLIO														
D1 mm	Dmin mm	Dmax mm	D2 mm	L1 mm	€	€	€	€	€					
6,35	2,0	5,0	6,35	45	AV100	14,22	AV100T	25,71	AV200	24,19	AV200T	40,69	AV100-60	25,50
10,00	2,0	5,0	6,00	45	AV101	16,58	AV101T	25,71	AV201	24,98	AV201T	40,69	AV101-60	31,85
14,00	6,0	13,0	8,00	50	AV102	19,96	AV102T	34,40	AV202	29,10	AV202T	50,74	AV102-60	38,66
20,00	8,0	18,0	10,00	65	AV103	33,76	AV103T	58,13	AV203	52,02	AV203T	85,89	AV103-60	44,12
27,00	11,0	25,0	12,00	85	AV104	66,65	AV104T	105,58	AV204	84,76	AV204T	135,29	AV104-60	76,85
30,00	12,0	28,0	15,00	95	AV105	101,80	AV105T	181,36	AV205	134,67	AV205T	232,48	AV105-60	125,94
35,00	14,0	33,0	15,00	100	AV106	163,65	AV106T	259,89	AV206	225,60	AV206T	390,97	AV106-60	199,57
40,00	16,0	38,0	15,00	110	AV107	223,45	AV107T	365,25	AV207	259,58	AV207T	418,89	AV107-60	270,48
45,00	18,0	42,0	15,00	120	AV108	310,88	AV108T	465,83	AV208	390,11	AV208T	555,69	AV108-60	349,57
50,00	20,0	48,0	15,00	130	AV109	401,35	AV109T	579,50	AV209	519,93	AV209T	697,67	AV109-60	425,92

SVASATORE CONICO 90° MULTITAGLIO

Ref. FC

TiAIN

MD

D1 mm	D2 mm	L mm	L2 mm	D3 mm	Z	FC	€
0,5	0,1	39,0	3,0	3,0	3	FC0050	66,80
0,6	0,1	39,0	3,0	3,0	3	FC0060	66,80
0,7	0,1	39,0	3,0	3,0	3	FC0070	66,80
0,8	0,1	39,0	3,0	3,0	3	FC0080	66,80
0,9	0,1	39,0	3,0	3,0	3	FC0090	66,80
1,0	0,1	39,0	3,0	3,0	3	FC0100	64,48
1,5	0,1	39,0	4,5	3,0	3	FC0150	64,48
2,0	0,1	39,0	6,0	3,0	3	FC0200	64,48
2,5	0,1	39,0	7,5	3,0	3	FC0250	64,48
3,0	0,1	39,0	-	3,0	3	FC0300	64,48
4,0	0,8	54,0	-	4,0	4	FC0400	66,80
6,0	0,8	57,0	-	6,0*	4	FC0600	70,24
8,0	0,8	63,0	-	8,0*	5	FC0800	77,14
10,00	1,0	72,0	-	10,0*	6	FC1000	92,11
12,00	1,2	83,0	-	12,0*	6	FC1200	135,87
16,00	1,6	92,0	-	16,0*	6	FC1600	242,97
20,00	2,0	104,0	-	20,0*	6	FC2000	444,48

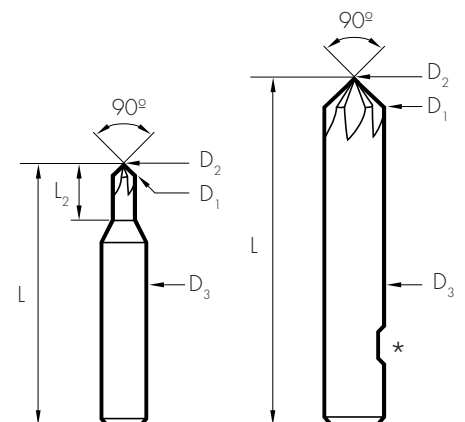

*Con piano di trascinamento

SVASATORI CODOLO CONICO
3Z

Ref. AV17

**DIN
335D**
HSS

90°

Ref. AV17MD

**DIN
335D**
MD

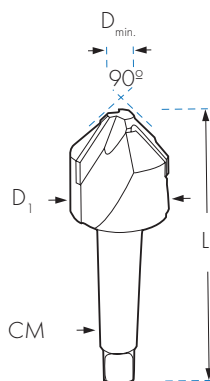
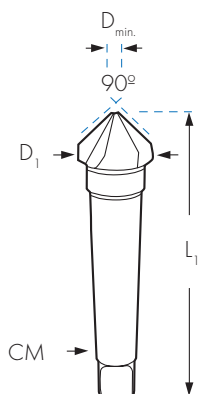
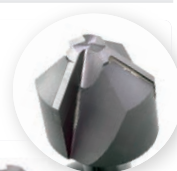
90°

AV17

AV17MD

D1 mm	D min. mm	L1 mm	CM	€
16,50	4,0	90	1	82,81
20,50	3,5	100	2	98,57
25,00	3,8	106	2	99,59
31,00	4,2	112	2	103,09
40,00	10,0	140	3	148,69
50,00	14,0	150	3	187,16
63,00	16,0	180	4	330,13
80,00	22,0	190	4	588,42
100,00	25,0	210	4	1.530,95

D1 mm	D min. mm	L1 mm	CM	€
63,00	16,0	190	4	1.525,71*
80,00	22,0	190	4	1.862,60*

*Fino ad esaurimento scorte

SVASATORI MULTITAGLIO CODOLO CONICO
**MULTI
TAGLIO**

Ref. AV23

**DIN
334B**

60°

Ref. AV18

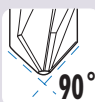
**DIN
335B**

90°

Ref. AV24

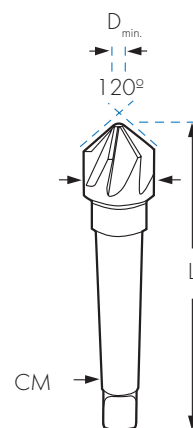
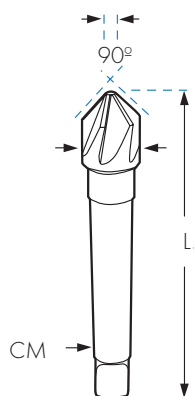
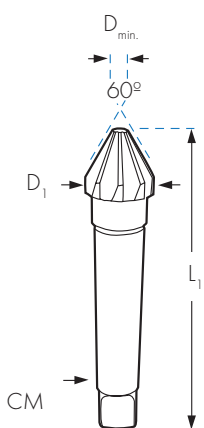
**DIN
347B**

120°

AV23

AV18

AV24



D1 mm	D min. mm	L1 mm	CM	Z	HSS €
16,00	3,2	93	1	7	66,60
20,00	4,0	116	2	7	77,97
25,00	7,0	121	2	9	85,40
31,50	9,0	124	2	9	116,79
40,00	12,5	150	3	11	213,72
50,00	16,0	153	3	13	255,48
63,00	20,0	185	4	15	391,12
80,00	25,0	196	4	17	604,47
100,00	22,0	230	4	3	1.904,70

D1 mm	D min. mm	L1 mm	CM	Z	HSS €
16,00	3,2	93	1	7	67,92
20,00	4,0	116	2	7	79,44
25,00	7,0	121	2	9	87,10
31,50	9,0	124	2	9	119,15
40,00	12,5	150	3	11	218,06
50,00	16,0	153	3	13	260,53
63,00	20,0	185	4	15	374,04
80,00	25,0	196	4	17	616,60
100,00	22,0	190	4	20	1.662,12

D1 mm	D min. mm	L1 mm	CM	Z	HSS €
16,00	3,2	93	1	7	69,16
20,00	4,0	116	2	7	80,96
25,00	7,0	121	2	9	92,99
31,50	9,0	124	2	9	121,29
40,00	12,5	150	3	11	193,14
50,00	16,0	153	3	13	249,46
63,00	20,0	185	4	15	406,16
80,00	25,0	196	4	17	627,71
100,00	27,0	210	4	3	1.647,43

SVASATORI A 1 CANALE



HSS CODOLO CILINDRICO
Ref. AV27
Ref. AV29



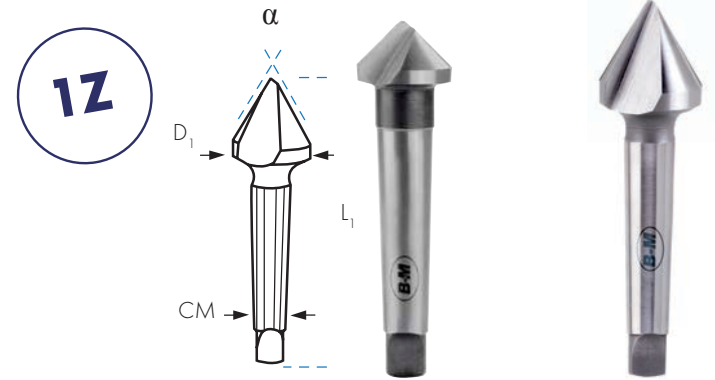
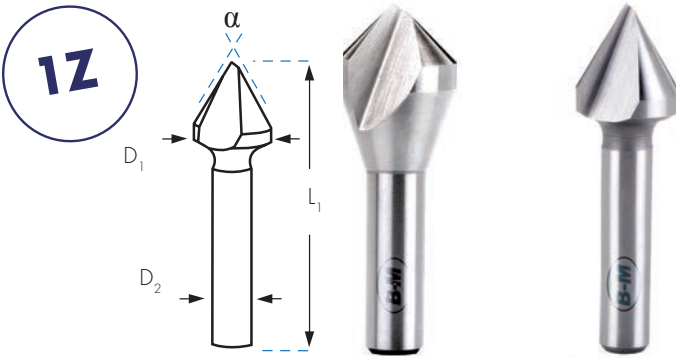

HSS CODOLO CONICO
Ref. AV34
Ref. AV28





	D1 mm	D2 mm	L1 mm	 €	 €
AV270600	6,0	5,0	45	14,39	AV290600 26,52
AV270800	8,0	8,0	50	15,18	AV290800 27,79
AV271000	10,0	8,0	50	16,09	AV291000 29,10
AV271200	12,0	8,0	50	18,75	AV291200 32,68
AV271600	16,0	10,0	56	22,32	AV291600 39,80
AV272000	20,0	10,0	60	30,50	AV292000 51,14
AV272500	25,0	10,0	75	40,19	AV292500 80,54
AV273000	30,0	12,0	80	57,94	AV293000 105,17
AV274000	40,0	13,0	89	151,02	AV294000 182,82
AV275000	50,0	13,0	98	186,45	AV295000 273,12

	D1 mm	CM	L1 mm	 €	 €
AV341600	16,0	1	92	69,15	AV281600 66,16
AV342000	20,0	2	107	86,65	AV282000 72,48
AV342500	25,0	2	110	111,59	AV282500 107,45
AV343000	30,0	2	114	126,81	AV283000 141,60
AV344000	40,0	3	145	204,03	AV284000 186,44
AV345000	50,0	3	152	297,92	AV285000 283,13

SVASATORI ESTERNI A 3 TAGLIANTI

3Z **HSS**  Ref. AVX **HSS**  Ref. AVX-60

AVX					
Dmax. mm	Dmin. mm	D2 mm	L1 mm		€
12,00	4,0	8,0	55	AVX1	46,81
20,00	8,0	10,0	60	AVX2	81,19
28,00	10,0	13,0	70	AVX3	115,16
40,00	12,0	CM2	125	AVX4	241,34
50,00	15,0	CM3	130	AVX5	337,19

AVX-60					
Dmax. mm	Dmin. mm	D2 mm	L1 mm		€
8,00	3,0	8,0	55	AVX1-60	45,00
15,00	6,0	10,0	60	AVX2-60	89,34
28,00	10,0	13,0	75	AVX3-60	133,89

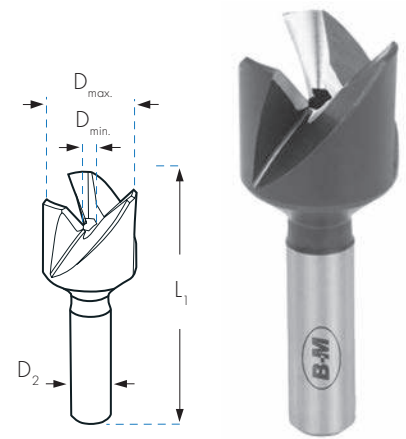

SVASATORE ESTERNO PER RIPARAZIONE DEI FILETTI DI ATTACCO

Ref. AVEXT **HSS** 



Min.-Max.		L1 mm		€
M8-M18	1/4"	75	AVEXT	37,48



SVASATORI PER SEDI DI VITI "ALLEN"
CODOLO CILINDRICO
**DIN
373**
HSS

NOTA: La lunghezza di taglio si intende senza guida.

* La regolazione grossa si utilizza per svasare fori filettati.

Ref. AV2

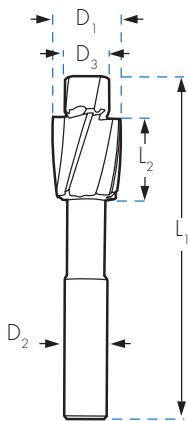

PER SVASARE FORI FILETTATI



AV2M

AV2MM

AV2GM

REGOLAZIONE						FINE			MEDIA			FORO FILETTATO	
	D ₁ mm	D ₂ mm	L ₁ mm	L ₂ mm		D ₃ mm	€		D ₃ mm	€		D ₃ mm	€
M3	6,0	5,0	71	14	AV2M3	3,2	25,46	AV2MM3	3,4	26,89	AV2GM3	2,5	26,89
M4	8,0	5,0	71	14	AV2M4	4,3	25,46	AV2MM4	4,5	26,89	AV2GM4	3,3	26,89
M5	10,0	8,0	80	18	AV2M5	5,3	25,46	AV2MM5	5,5	26,89	AV2GM5	4,2	26,89
M6	11,0	8,0	80	18	AV2M6	6,4	28,70	AV2MM6	6,6	30,31	AV2GM6	5,0	30,31
M7	20,0	12,7	90	20	AV2M7	7,4	53,01						
M8	15,0	12,5	100	22	AV2M8	8,4	35,59	AV2MM8	9,0	37,57	AV2GM8	6,8	37,57
M10	18,0	12,5	100	22	AV2M10	10,5	42,36	AV2MM10	11,0	44,74	AV2GM10	8,5	44,74
M11	22,0	18,8	100	22	AV2M11	11,5	56,39						
M12	20,0	12,5	100	22	AV2M12	13,0	49,42	AV2MM12	14,0	52,19	AV2GM12	10,2	52,19
M14	24,0	12,5	100	22	AV2M14	15,0	77,30	AV2MM14	15,5	81,63	AV2GM14	12,0	81,63
M16	26,0	12,5	100	22	AV2M16	17,0	85,03	AV2MM16	17,5	89,79	AV2GM16	14,0	89,79

TESTA CONICA CON GUIDA
**DIN
1866**
HSS

NOTA: La lunghezza di taglio si intende senza guida

Ref. AV3

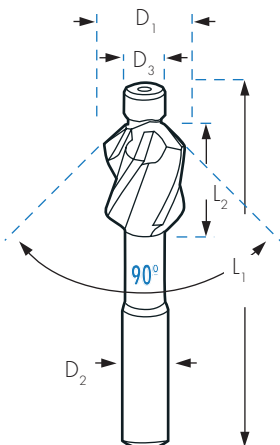

REGOLAZIONE						AV3	
	D ₁ mm	D ₂ mm	L ₁ mm	L ₂ mm		D ₃ mm	FINE €
M3	6,3	6,0	71	14,0	AV3M3	3,2	24,32
M4	8,3	8,0	71	14,0	AV3M4	4,3	33,11
M5	10,4	10,0	80	18,0	AV3M5	5,3	35,48
M6	12,4	10,0	80	18,0	AV3M6	6,4	40,34
M8	16,5	12,0	100	22,0	AV3M8	8,4	49,35
M10	20,5	12,0	100	22,0	AV3M10	10,5	53,40
M12	24,5	13,0	110	25,0	AV3M12	13,0	65,07

SVASATORI PER SEDI DI VITI "ALLEN"

CODOLO CONICO

Ref. AV5

DIN
375

HSS

NOTA: La lunghezza di taglio si intende senza guida.
* La regolazione grossa si utilizza per svasare fori filettati.

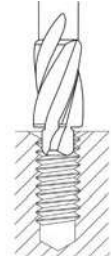
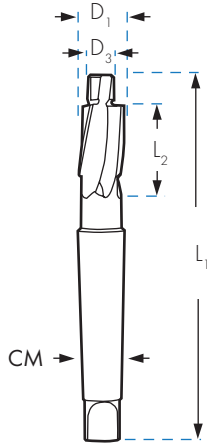

PER SVASARE FORI FILETTATI



AV5M

AV5MM

AV5GM

REGOLAZIONE						FINE		MEDIA		FORO FILETTATO			
	D1 mm	CM	L1 mm	L2 mm		D3 mm	€	D3 mm	€	D3 mm	€		
M8	15,0	2	132	22	AV5M8	8,4	70,26	AV5MM8	9,0	70,26	AV5GM8	6,8	70,26
M10	18,0	2	140	25	AV5M10	10,5	72,12	AV5MM10	11,0	72,12	AV5GM10	8,5	72,12
M12	20,0	2	140	25	AV5M12	13,0	79,78	AV5MM12	14,0	79,78	AV5GM12	10,2	79,78
M14	24,0	2	150	30	AV5M14	15,0	110,75	AV5MM14	15,5	110,75	AV5GM14	12,0	110,75
M16	26,0	3	180	35	AV5M16	17,0	130,04	AV5MM16	17,5	130,04	AV5GM16	14,0	130,04
M18	30,0	3	180	35	AV5M18	19,0	140,31	AV5MM18	20,0	140,31	AV5GM18	15,5	140,31
M20	33,0	3	190	40	AV5M20	21,0	152,88	AV5MM20	22,0	152,88	AV5GM20	17,5	152,88
M22	36,0	3	190	40	AV5M22	23,0	186,31	AV5MM22	24,0	186,31	AV5GM22	19,5	186,31
M24	40,0	3	190	40	AV5M24	25,0	225,23	AV5MM24	26,0	225,23	AV5GM24	21,0	225,23
M27	46,0	4	255	50	AV5M27	30,0	255,93						
M30	48,0	4	255	50	AV5M30	33,0	309,59						

APPLICAZIONI DEI TIPI DI REGOLAZIONE: FINE, MEDIA E FORO FILETTATO

T₁: Viti testa cilindrica DIN 84 e DIN 7984
Viti Autofilettanti DIN 7513
DIN 7500

T₂: Viti testa cilindrica DIN 6912

T₃: Viti testa cilindrica DIN 912

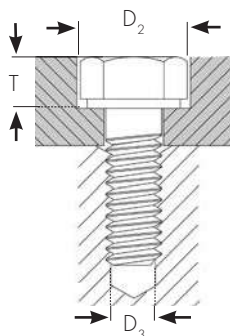

FILETTATURE METRICHE	FINE	MEDIA	FORO FILETTATO	D ₂ mm	T ₁ mm	T ₂ mm	T ₃ mm
	D ₃ mm	D ₃ mm	D ₃ mm				
M3	3,2	3,4	2,5	6,0	2,4	--	3,4
M4	4,3	4,5	3,3	8,0	3,2	3,4	4,6
M5	5,3	5,5	4,2	10,0	4,0	4,2	5,7
M6	6,4	6,6	5,0	11,0	4,7	4,8	6,8
M8	8,4	9,0	6,8	15,0	6,0	6,0	6,0
M10	10,5	11,0	8,5	18,0	7,0	7,5	11,0
M12	13,0	13,5	10,2	20,0	8,0	8,5	13,0
M14	15,0	15,5	12,0	24,0	9,0	9,5	15,0
M16	17,0	17,5	14,0	26,0	10,5	11,5	17,5
M18	19,0	20,0	15,5	30,0	11,5	12,5	19,5
M20	21,0	22,0	17,5	33,0	12,5	13,5	21,5
M22	23,0	24,0	19,5	36,0	13,5	14,5	23,5

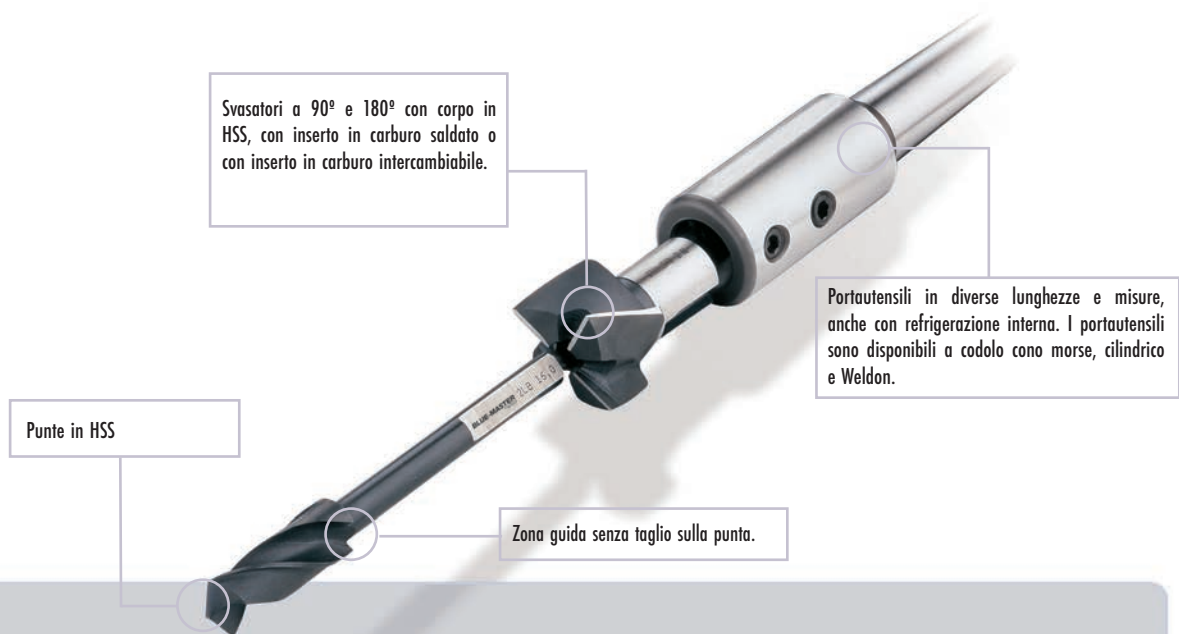
SVASATORI CON ELEMENTI INTERCAMBIABILI PER SEDI DI VITI CON TESTA "ALLEN" E CONICA

IL SISTEMA BLUEMASTER

Il sistema BLUEMASTER è unico per le operazioni di svasatura, incrementandone la produttività e diminuendone i costi.

I nostri portautensili, frese, punte e guide si possono combinare per adattarli a tutti i tipi di macchine e applicazioni.

Può comporre facilmente più di 1.500.000 utensili speciali con solo 1.300 pezzi.

Il sistema è costituito da 3 gruppi di dimensioni: **SERIE A**, **SERIE B** e **SERIE C**.

Tutte le combinazioni devono essere formate da elementi appartenenti allo stesso gruppo. Utensili di gruppi differenti non sono combinabili tra loro.

Nelle pagine seguenti troverà gli intervalli di misure disponibili per ogni gruppo e i consigli per la scelta corretta sia dell'utensile sia dei parametri di taglio.

Importante!

- * Per l'utilizzo con metallo duro, collocare la vite di regolazione assiale in contatto con la guida o la punta inserita.
- * Lasciare uno spazio tra il filo e la guida o la punta per prevenire rotture da impatto accidentale.
- * La vite assiale si usa anche per prolungare la vita delle punte prima di riaffilarle.

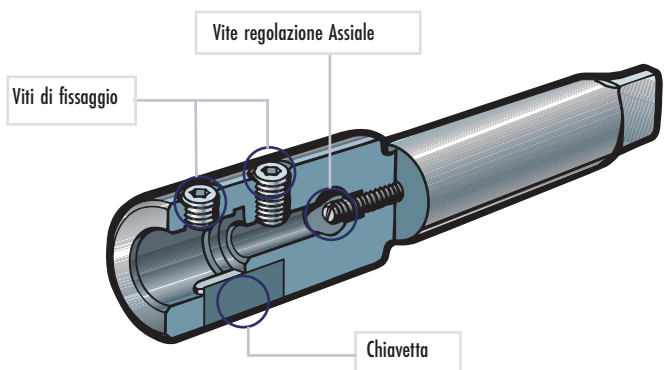
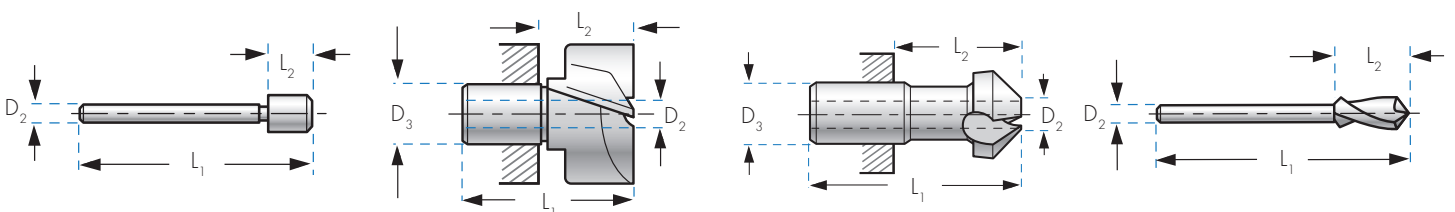
DIMENSIONI DI GUIDA, MANDRINO E PUNTA

	GUIDA				MANDRINO					SVASATORE					PUNTA		
	D ₂ mm	L ₁ mm	L ₂ mm		D ₃ mm	D ₂ mm	L ₁ mm	L ₂ mm		D ₃ mm	D ₂ mm	L ₁ mm	L ₂ mm		D ₂ mm	L ₁ mm	L ₂ mm
AGP	4	64	9	APAV-MD-PQ	10	4	40	22	AVC	10	4	40	22	ABP	4	70	15
BGP	6	80	14	BPAV-MD-PQ	14	6	48	28	BVC	14	6	48	28	BBP	6	95	25
CGP	10	110	20	CPAV-MD-PQ	22	10	61	33	CVC	22	10	61	33	CBP	10	125	30

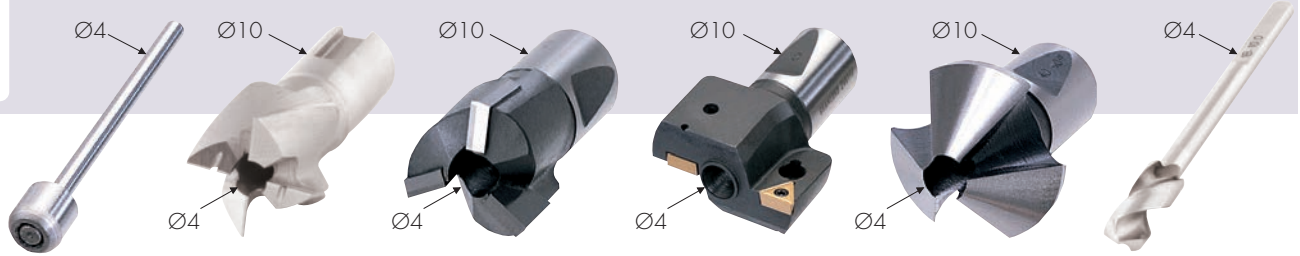
SVASATORI CON ELEMENTI INTERCAMBIABILI PER SEDI DI VITI CON TESTA "ALLEN" E CONICA
**SERIE
A**

GUIDA

MANDRINO

MANDRINO

PLACCHETTA INTERCAMBIABILE

SVASATORE

PUNTA

AGP
APAV
APAVMD
APAVPQ
AVC
ABP

AGP €	APAV HSS €		APAVMD MD €		APAVPQ placchetta non inclusa PMD €		AVC 90° HSS €		ABP HSS €		
									ABP0430	81,98	
									ABP0450	81,98	
									ABP0500	81,98	
									ABP0530	81,98	
									ABP0550	81,98	
AGP0400	47,30								ABP0600	96,34	
AGP0450	56,40	APAV0700	144,35					AVC0800	188,12	ABP0640	96,34
AGP0550	56,40	APAV0800	142,58						188,12	ABP0650	96,34
AGP0600	56,40	APAV0900	142,58						188,12		
AGP0650	56,40	APAV1000	138,04	APAVMD1000	405,38			AVC1000	188,12		
AGP0640	56,40								190,94		
AGP0660	56,40	APAV1100	142,58	APAVMD1100	405,38			AVC1200	190,94	ABP0660	96,34
AGP0500	56,40										
		APAV1150	157,66							ABP0700	96,34
		APAV1200	144,35	APAVMD1200	405,38			AVC1150	184,63		
		APAV1250	160,11					AVC1240	193,15		
		APAV1300	157,32	APAVMD1300	405,38						
		APAV1350	181,13					AVC1350	193,15		
		APAV1400	157,32	APAVMD1400	409,23			AVC1400	207,06		
		APAV1450	181,49								
AGP0840	57,11										
AGP0900	57,11	APAV1500	159,08	APAVMD1500	413,79			AVC1500	208,79		
AGP0680	56,40										
AGP0700	56,40	APAV1600	168,16	APAVMD1600	423,25			AVC1600	209,86		
AGP0750	56,40	APAV1700	171,35	APAVMD1700	432,36			AVC1650	204,27		
AGP0800	57,11	APAV1800	175,87	APAVMD1800	441,43	APAVPQ1800	922,13				
AGP0850	57,11	APAV1900	187,11	APAVMD1900	461,42						
AGP0900	57,11	APAV2000	193,75	APAVMD2000	471,24	APAVPQ2000	1.033,57				
AGP0950	57,11	APAV2100	211,29	APAVMD2100	493,64						
AGP1000	57,11										
AGP1050	57,11										
AGP1100	57,11										
AGP1150	57,11										

ADATTATORI

	D1 mm	D2 mm	L1 mm	L2 mm	CM Ømm	APH
						€
APHCM1	18	10	110	48	CM1	338,09
APHCM2	18	10	132	57	CM2	331,80
APH-10	18	10	92	42	Ø10	316,01

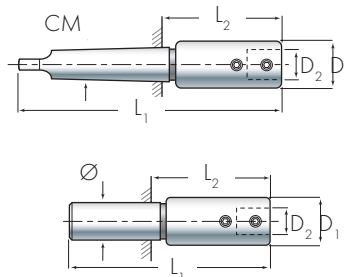
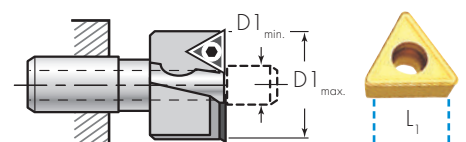
PLACCHETTE DI RICAMBIO

	L1 mm	D1_min. Ømm	D1_max. Ømm	PPQ
				€
PPQ07	7	18	20	35,04

SVASATORI CON ELEMENTI INTERCAMBIABILI PER SEDI DI VITI CON TESTA "ALLEN" E CONICA

Svasatori

Rosa

SERIE B

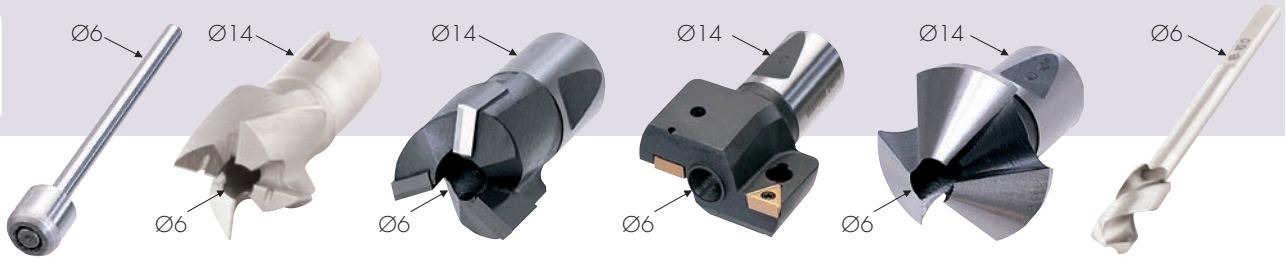

GUIDA		MANDRINO		MANDRINO		PLACCHETTA INTERCAMBIABILE		SVASATORE		PUNTA	
BGP		BPAV		BPAVMD		BPAVPQ		BVC		BBP	
€		HSS	€	MD	€	placchetta non inclusa	PMD	90°	HSS	€	HSS
		€	€	€	€		€		€		€
			BPAV1300 159,76		BPAVMD1300 432,36						
			BPAV1350 180,42								
			BPAV1400 159,76		BPAVMD1400 432,36						
			BPAV1450 180,42								BBP0800 114,57
BGP0840	53,26										
BGP0900	53,26		BPAV1500 159,76		BPAVMD1500 432,36			BVC15	198,31		BBP0900 114,57
BGP0680	53,26										
BGP0800	53,26										
BGP1000	53,26		BPAV1550 182,89								
BGP1150	56,40		BPAV1600 168,54		BPAVMD1600 448,45						BBP0840 114,57
BGP1250	58,50		BPAV1650 195,49								BBP0850 114,57
BGP1350	64,46		BPAV1700 175,51		BPAVMD1700 448,45						BBP0950 114,57
BGP1450	65,15		BPAV1750 196,88								BBP1000 130,68
			BPAV1900 202,51		BPAVMD1900 452,33						BBP1050 130,68
BGP1050	56,40										
BGP1100	56,40		BPAV1800 182,19		BPAVMD1800 452,33			BVC20	224,23		BBP1100 130,68
BGP0850	53,26										
BGP1300	64,46										
BGP1400	65,15		BPAV2000 202,51		BPAVMD2000 466,34	BPAVPQ2000	922,91	BVC25	233,36		
BGP1020	56,40										
BGP1500	65,15										
BGP1550	65,15		BPAV2400 239,31		BPAVMD2400 495,42	BPAVPQ2400	924,11	BVC28	271,51		
BGP1200	56,40										
BGP1700	65,15										
BGP1750	65,15		BPAV2600 255,76		BPAVMD2600 498,21	BPAVPQ2600	1.059,55	BVC30	277,50		
BGP1400	65,15										
BGP1900	66,55										
BGP2000	83,04		BPAV3000 345,45		BPAVMD3000 543,43	BPAVPQ3000	1.059,55				
			BPAV3400 408,51		BPAVMD3400 626,75	BPAVPQ3400	1.222,95				

ADATTATORI

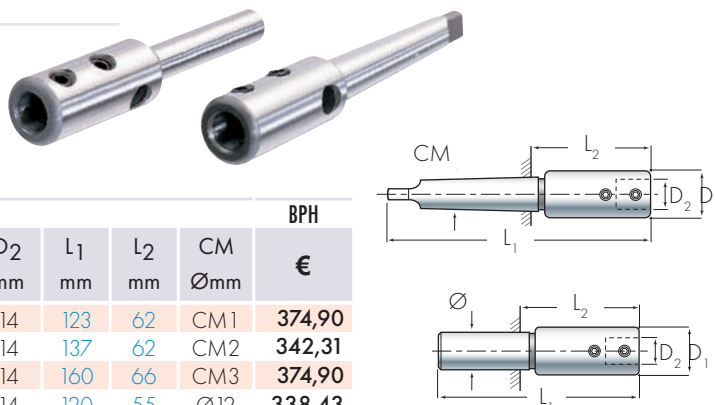

BPH						
	D1 mm	D2 mm	L1 mm	L2 mm	CM Ømm	€
BPHCM1	24	14	123	62	CM1	374,90
BPHCM2	24	14	137	62	CM2	342,31
BPHCM3	24	14	160	66	CM3	374,90
BPH-12	24	14	120	55	Ø12	338,43

PLACCHETTE DI RICAMBIO

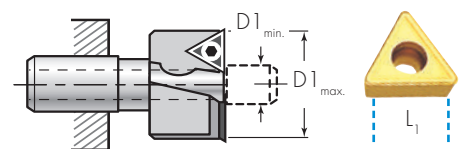

PPQ				
	L1 mm	D1 min. Ømm	D1 max. Ømm	€
PPQ07	7	20	25	35,04
PPQ10	10	26	33	31,54
PPQ12	12	34	36	31,54

SVASATORI CON ELEMENTI INTERCAMBIABILI PER SEDI DI VITI CON TESTA "ALLEN" E CONICA

SERIE
C

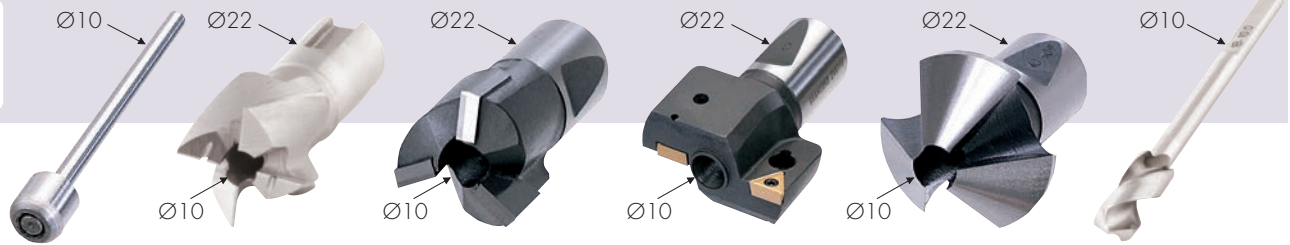

GUIDA

MANDRINO

MANDRINO

PLACCHETTA INTERCAMBIABILE

SVASATORE

PUNTA

CGP	CPAV		CPAVMD		CPAVPQ		CVC		CBP		
	€	HSS €		MD €	placchetta non inclusa	PMD €	HSS €		HSS €		
CGP1200	60,60	CPAV2300	290,10	CPAVMD2300	540,60						
CGP1250	60,60	CPAV2400	293,94	CPAVMD2400	534,98						
CGP1300	60,60	CPAV2500	317,79	CPAVMD2500	536,05						
CGP1350	60,60	CPAV2600	324,09	CPAVMD2600	550,77						
CGP1400	71,14	CPAV2700	328,63								
CGP1450	71,14	CPAV2800	334,94	CPAVMD2800	556,01						
CGP1500	71,14	CPAV2900	342,99							CBP1700	286,25
CGP1600	71,14	CPAV3100	372,79							CBP1800	322,68
CGP1650	71,14	CPAV3200	385,06	CPAVMD3200	607,16					CBP1900	338,43
CGP1700	71,14	CPAV3300	388,55							CBP2100	366,85
CGP1900	71,14									CBP2300	441,43
CGP2000	71,14	CPAV3000	347,54	CPAVMD3000	613,13			CVC35	404,65	CBP2000	366,85
CGP1550	71,14										
CGP2100	79,20										
CGP2200	79,20	CPAV3400	392,42	CPAVMD3400	651,67	CPAVPQ3400	1.264,68	CVC37	428,15	CBP2200	409,23
CGP1750	71,14										
CGP1850	71,14	CPAV3500	410,98								
CGP2300	79,20										
CGP2400	79,20	CPAV3600	415,88	CPAVMD3600	669,52	CPAVPQ3600	1.264,68	CVC37	428,15	CBP2400	450,94
CGP1950	71,14										
CGP2500	79,20										
CGP2600	97,39	CPAV4000	482,80	CPAVMD4000	741,70	CPAVPQ4000	1.293,82	CVC40	455,12		
CGP2100	79,20										
CGP2200	79,20	CPAV4500	595,62			CPAVPQ4500	1.317,44				
CGP2050	79,20	CPAV5000	865,04			CPAVPQ5000	1.541,49				
		CPAV5500	911,28			CPAVPQ5500	1.820,64				
		CPAV6000	960,32			CPAVPQ6000	1.820,64				
		CPAV6500	1.080,17			CPAVPQ6500	2.082,07				

ADATTATORI



	D1 mm	D2 mm	L1 mm	L2 mm	CM Ømm	CPH
						€
CPHCM2	36	22	160	85	CM2	493,64
CPHCM3	36	22	180	87	CM3	466,34
CPHCM4	36	22	206	89	CM4	522,75
CPHCM5	36	22	240	91	CM5	1.150,24
CPH-12	36	22	140	71	Ø20	338,43

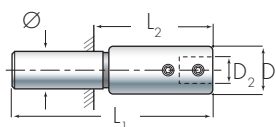
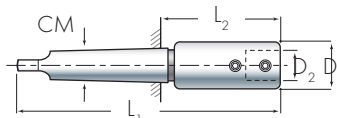

PLACCHETTE DI RICAMBIO

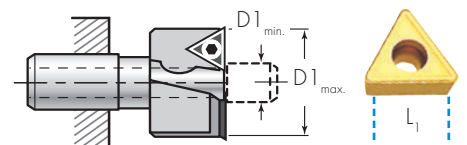

	L1 mm	D1 min. Ømm	D1 max. Ømm	PPQ
				€
PPQ12	12	34	45	31,54
PPQ17	17	<46		48,88

SET DI SVASATORI
SET DI PUNTE A SVASARE PER TUBI E LAMIERE HSS E HSSCo
HSS

(Punte Ref. AV30)

AV30BM0 AV30BM1 AV30BM2

REFERENZA	AV30BM012	
N° PUNTE	3	
QUALITÀ	HSS	
CONTENUTO	AV30BM0 - AV30BM1 - AV30BM2 (3-14mm) (6-20mm) (16-30mm)	
P.V.P. €	HSS	96,70
€	HSS	TiN 183,54

HSSCo

(Punte Ref. AVC30)

AVC30BM0 AVC30BM1 AVC30BM2

REFERENZA	AVC30BM012	
N° PUNTE	3	
QUALITÀ	HSSCo	
CONTENUTO	AVC30BM0 - AVC30BM1 - AVC30BM2 (3-14mm) (6-20mm) (16-30mm)	
P.V.P. €	HSS Co	140,65
€	HSS Co	TiN 198,13

SET DI PUNTE A GRADINO ELICOIDALE HSS
HSS

(Punte Ref. AV42)

AV42BM2 AV42BM3 AV42BM4

REFERENZA	AV42BM234	
N° PUNTE	3	
QUALITÀ	HSS	
CONTENUTO	AV42BM2 - AV42BM3 - AV42BM4	
P.V.P. €	HSS	168,92
€	HSS	TiN 244,86



SET DI PUNTE A GRADINO

SET DI PUNTE A GRADINO A CANALI DRITTI HSS

HSS



AV40BM2 AV40BM3 AV40BM4 AV40BM5 AV40BM13



PAV40BM234



PAV40BM235



PAV40BM2313

(Punte Ref. AV40)

REFERENZA	PAV40BM234	PAV40BM235	PAV40BM2313
N° PUNTE	3	3	3
CONTENUTO	AV40BM2 - AV40BM3 - AV40BM4 (4-12mm) (4-20mm) (4-30mm)	AV40BM2 - AV40BM3 - AV40BM5 (4-12mm) (4-20mm) (6-38mm)	AV40BM2 - AV40BM3 - AV40BM13 (4-12mm) (4-20mm) (6-40mm)
P.V.P. €	132,88	223,71	265,83
€	HSS TiN	HSS TiN	HSS TiN



AV40BM234



AV40BM22122

(Punte Ref. AV40)

REFERENZA	AV40BM234	AV40BM22122
N° PUNTE	3	3
CONTENUTO	AV40BM2 - AV40BM3 - AV40BM4 (4-12mm) (4-20mm) (4-30mm)	AV40BM2 - AV40BM21 - AV40BM22 (4-12mm) (7+10-20mm) (10+20-30mm)
P.V.P. €	132,88	173,92
€	HSS TiN	HSS TiN

(Punte Ref. AVC40)

REFERENZA	AVC40BM234
N° PUNTE	3
CONTENUTO	AVC40BM2 - AVC40BM3 - AVC40BM4 (4-12mm) (4-20mm) (4-30mm)
P.V.P. €	175,98
€	HSS Co TiN

SET DI SVASATORI

(Svasatori Ref. AV6)



REFERENZA	AV6CM1	AV6CM2	AV6CM3	PAV6CM2
N° PUNTE	6	6	7	6
CONTENUTO	Ø 6 - 8 - 10 - 11,5 - 15 - 19 mm	Ø 6,3 - 8,3 - 10,4 - 12,4 - 16,5 - 20,5 mm	Ø 6,3 - 8,3 - 10,4 - 12,4 - 16,5 - 20,5 - 25 mm	Ø 6,3 - 8,3 - 10,4 - 12,4 - 16,5 - 20,5 mm
P.V.P. €	116,18	121,98	165,87	121,98



(Svasatori Ref. AV7)



REFERENZA	AV7CM1	AV7CM2	AV7CM3	PAV7CM2
N° PUNTE	6	6	7	6
CONTENUTO	Ø 6 - 8 - 10 - 11,5 - 15 - 19 mm	Ø 6,3 - 8,3 - 10,4 - 12,4 - 16,5 - 20,5 mm	Ø 6,3 - 8,3 - 10,4 - 12,4 - 16,5 - 20,5 - 25 mm	Ø 6,3 - 8,3 - 10,4 - 12,4 - 16,5 - 20,5 mm
P.V.P. €	145,28	141,70	196,33	141,70



(Svasatori Ref. AV16)



REFERENZA	AV16CM1	AV16CM2	AV16CM3
N° PUNTE	6	6	7
CONTENUTO	Ø 6 - 8 - 10 - 11,5 - 15 - 19 mm	Ø 6,3 - 8,3 - 10,4 - 12,4 - 16,5 - 20,5 mm	Ø 6,3 - 8,3 - 10,4 - 12,4 - 16,5 - 20,5 - 25 mm
P.V.P. €	254,76	210,11	290,12



(Svasatori Ref. AV8)



REFERENZA	AV8CM2	AV8CM3
N° PUNTE	6	7
CONTENUTO	Ø 6,3 - 8 - 10 - 12,5 - 16 - 20 mm	Ø 6,3 - 8 - 10 - 12,5 - 16 - 20 - 25 mm
P.V.P. €	162,11	215,44

* Altri set su richiesta AV99, ecc.

SET DI SVASATORI

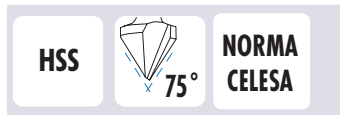

(Svasatori Ref. AV9)

REFERENZA	AV9CM1	AV9CM5
N° PUNTE	6	7
CONTENUTO	Ø 6,3 - 8,3 - 10,4 - 12,4 - 16,5 - 20,5 mm	Ø 6,3 - 8,3 - 10,4 - 12,4 - 16,5 - 20,5 - 25 mm
P.V.P. €	172,69	236,16



(Svasatori Ref. AV10)

REFERENZA	AV10CM1	AV10CM6
N° PUNTE	6	7
CONTENUTO	Ø 6,3 - 8,3 - 10,4 - 12,4 - 16,5 - 20,5 mm	Ø 6,3 - 8,3 - 10,4 - 12,4 - 16,5 - 20,5 - 25 mm
P.V.P. €	189,94	260,43



* Altri set su richiesta AV99, ecc.

SET DI SVASATORI PER SBAVARE CON FORO DI 90 HSS E HSSCO



(Svasatori Ref. AV1)

REFERENZA	AV1S2*
N° PUNTE	5
CONTENUTO	Ø 10 - 14 - 20 - 27 - 30 mm
P.V.P. €	226,81*



(Svasatori Ref. AV2)

REFERENZA	AV2S2*
N° PUNTE	5
CONTENUTO	Ø 10 - 14 - 20 - 27 - 30 mm
P.V.P. €	308,77*
€	HSS Co TiN
	507,97*

*Fino ad esaurimento scorte

SET DI SVASATORI PER SEDI DI VITI "ALLEN" REGOLAZIONE FINE, MEDIA E FORO FILETTATO

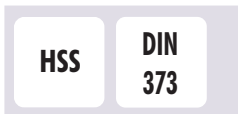

(Svasatori Ref. AV2M)



(Svasatori Ref. AV2MM)



(Svasatori Ref. AV2GM)

REFERENZA	AV2M3-10	AV2M3-10M	AV2M3-10G
N° PUNTE	6		
CONTENUTO	M3 - M4 - M5 - M6 - M8 - M10		
P.V.P. €	172,30	181,97	181,97

REFERENZA	AV2M3-12	AV2M3-12M	AV2M3-12G
N° PUNTE	7		
CONTENUTO	M3 - M4 - M5 - M6 - M8 - M10 - M12		
P.V.P. €	218,83	231,10	231,10



Ref. AV2M3-10

UTENSILI A SBAVARE DI PRECISIONE
GLI UTENSILI A SBAVARE BLUEMASTER

Gli utensili a sbavare BLUEMASTER si utilizzano per rimuovere i trucioli dai bordi e gli spigoli di pezzi fabbricati in metallo, plastica o legno.

Il sistema si completa unendo i tre componenti segnalati: LAMA + PORTALAME + CODOLO UNIVERSALE

Il codolo può essere utilizzato con tutti i gruppi di lame, sostituendo opportunamente il portalame per ognuno di essi.

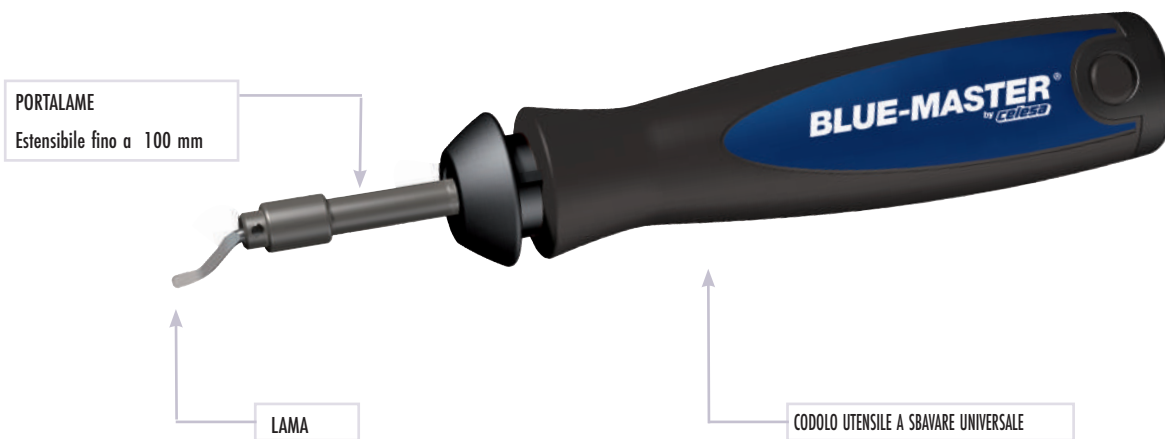
INSIEME B
JRB1
CONTENUTO B:

Ref. RB10



Ref. RBB1



Ref. RB20



Ref. RBB

 Blister: **34,11 €**
INSIEME C
JRB2
CONTENUTO C:

Ref. RC42

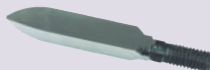

Ref. RBB1



Ref. RBC

 Blister: **62,11 €**
INSIEME D
JRB3
CONTENUTO D:

Ref. RD80MD



Ref. RBB1



Ref. RBD

 Blister: **97,89 €**
INSIEME E
JRB4
CONTENUTO E:

Ref. RE10



Ref. RBB1



Ref. RE20



Ref. RBE



Ref. RE30

 Blister: **37,98 €**

UTENSILI A SBAVARE DI PRECISIONE

GRUPPO
B

PORTALAME GRUPPO B



Ø2,6mm

Per lame a sbavare Gruppo B

RBB

11,98 €

LAME GRUPPO B

Lama a sbavare
Serie corta: acciaio, alluminio, plastica



RB10*

Blister 10 U.: 2,10 €/U.



Lama punzonatrice in metallo duro

RB50*

Blister 1 U.: 37,53 €

Lama a sbavare bidirezionale
Serie corta: ottone, ghisa



RB20

Blister 10 U.: 2,10 €/U.



Lama a sbavare per la parte posteriore di un trapano fino a 20 mm di profondità

RB60*

Blister 10 U.: 4,36 €/Ud

Lama a sbavare per la parte posteriore di un trapano fino a 20 mm di profondità



RB30

Blister 10 U.: 2,10 €/Ud



Lama a sbavare con spigoli esterni

RB70MD*

Blister 1 U.: 44,82 €

*Fino ad esaurimento scorte

GRUPPO
C

PORTALAME GRUPPO C



Per lame a sbavare Gruppo C

RBC

Blister 1 U.: 11,98 €

LAME GRUPPO C

Lama raschiatrice larghezza 4 x 20 mm



RC40*

Blister 1 U.: 24,41 €

Lama raschiatrice larghezza 8 x 30 mm



RC42*

Blister 1 U.: 30,36 €

*Fino ad esaurimento scorte

GRUPPO
D

PORTALAME GRUPPO D



Per lame a sbavare Gruppo D

RBD

Blister 1 U.: 11,98 €

LAME GRUPPO D

Lama a sbavare in metallo duro a "V" femmina bordi fino a 3 mm



RD80MD*

Blister 1 U.: 63,78 €

Lama a sbavare in metallo duro a "V" femmina bordi fino a 8 mm

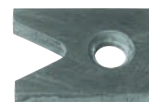

RD82MD*

Blister 1 U.: 100,01 €

*Fino ad esaurimento scorte

CODOLO UTENSILE A SBAVARE UNIVERSALE

Usi generali
 Adatto per portalamo:
 Ref. RBB / RBC / RBD / RBE / RBF

RBB1

 Blister 1 ud.: **15,72 €**
UTENSILI A SBAVARE DI PRECISIONE
**GRUPPO
E**
PORTALAME GRUPPO E

Portalamo gruppo E

RBE

 Blister 1 ud.: **11,98 €**
LAME GRUPPO E

Lama a sbavare per interni ed esterni
 Serie lunga: acciaio, alluminio, plastica

RE10

 Blister 10 ud.: **2,58 €**/Ud

Lama a sbavare per bordi retti: scanalatura di
 chiave,...

RE35

 Blister 10 ud.: **2,75 €**/Ud

Lama a sbavare bidirezionale
 Serie lunga: ottone, ghisa

RE20

 Blister 10 ud.: **2,58 €**/Ud

Lama a sbavare chiusa doppio spigolo per fori di 4
 mm di profondità

RE30

 Blister 10 ud.: **2,58 €**/Ud

Lama a sbavare per la parte posteriore di un trapa-
 no fino a 20 mm di profondità

RE60*

 Blister 5 ud.: **3,62 €**/Ud

*Fino ad esaurimento scorte

**GRUPPO
F**
PORTALAME GRUPPO F



Per lame a sbavare Gruppo F

RBF

 Blister 1 ud.: **11,98 €**
LAME GRUPPO F (Filettatura M05 x 0.80)

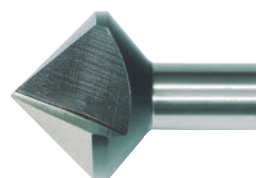

Lama a svasare HSS Ø 12 mm

RF12

 Blister 1 ud.: **26,92 €**

Lama a svasare HSS Ø 30 mm

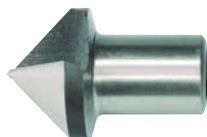
RF30

 Blister 1 ud.: **89,97 €**

Lama a svasare HSS Ø 20 mm

RF20

 Blister 1 ud.: **52,05 €**