

BLUE-MASTER[®]
by *celesa*

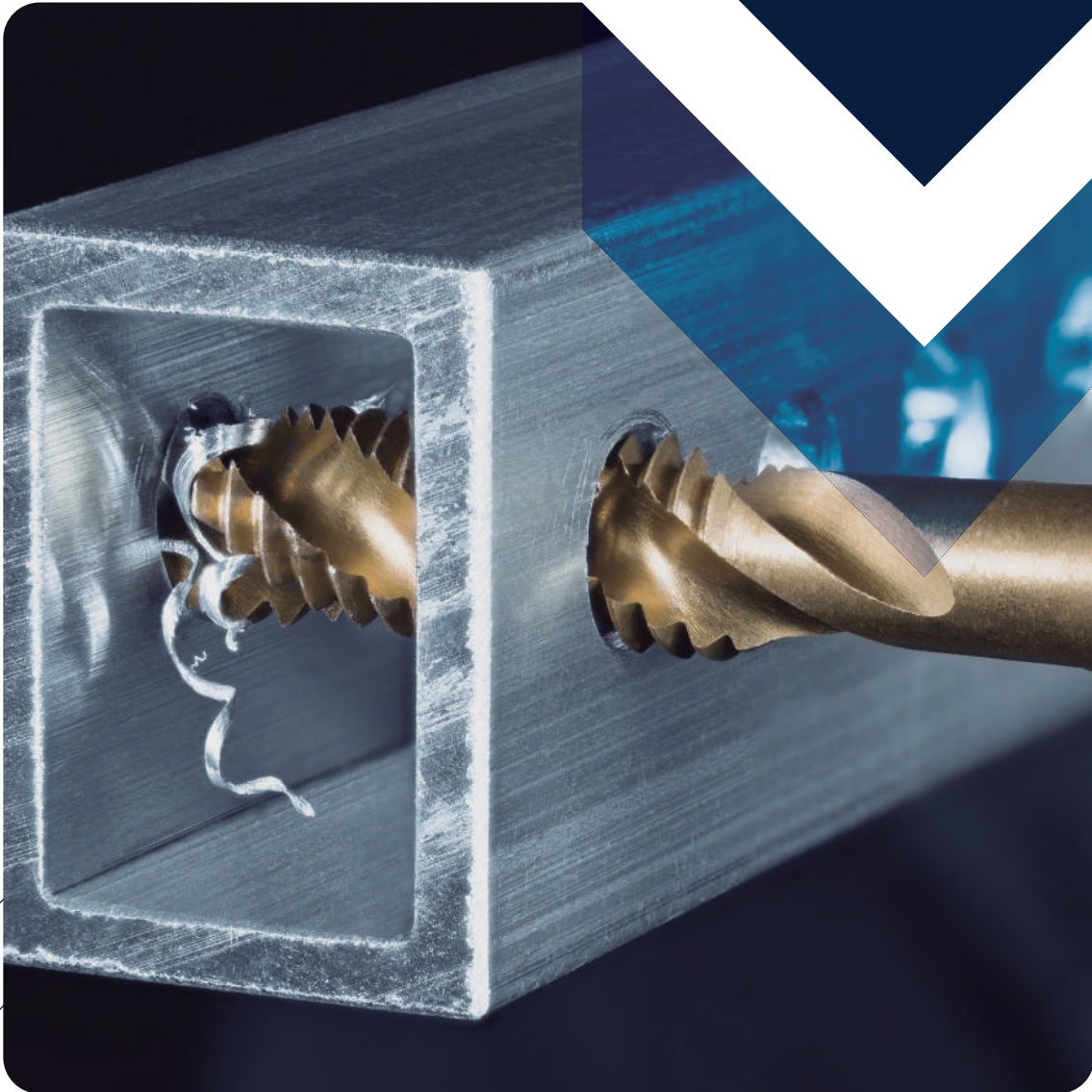
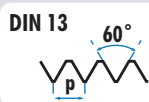

MACHOS
Y TERRAJAS

JUEGOS DE MACHOS Y TERRAJAS PARA ROSCAR A MANO HSS

Ref. M0

HSS

DIN
352DIN
2181TOL
6H

Ref. C5

HSS

DIN
223TOL
6g

Para materiales hasta 38 HRc



		M0			C5		
	Uds.	\varnothing	L1 x L2 x mm	€	\varnothing x L3 mm	€	
M 5,5x0,90	3	4,60	50 x 16 x 4,9	95,70	25 x 9	109,86	
M 6x0,50	2	5,50	50 x 14 x 4,9	32,50	20 x 5	42,50	
M 6x0,75	2	5,25	50 x 14 x 4,9	27,43	25 x 9	34,86	
M 6x1,00	3	5,00	50 x 19 x 4,9	24,29*	25 x 9	31,02*	
M 6x1,25	3	4,75	50 x 19 x 4,9	157,01	25 x 9	112,49	
M 7x0,75	2	6,25	50 x 14 x 4,9	36,01	25 x 9	34,51	
M 7x1,00	3	6,00	50 x 19 x 4,9	29,59*	25 x 9	32,56*	
M 7x1,25	3	5,75	50 x 19 x 4,9	109,10	25 x 9	135,20	
M 8x0,50	2	7,50	50 x 16 x 4,9	57,32	25 x 9	51,53	
M 8x0,75	2	7,25	50 x 16 x 4,9	37,73	25 x 9	37,32	
M 8x1,00	2	7,00	56 x 18 x 4,9	27,30*	25 x 9	35,98*	
M 8x1,25	3	6,80	56 x 22 x 4,9	29,56*	25 x 9	32,91*	
M 8x1,50	3	6,50	56 x 22 x 4,9	106,11	25 x 9	117,54	
M 9x1,00	2	8,00	63 x 18 x 5,5	39,97	25 x 9	39,99	
M 9x1,25	3	7,80	63 x 22 x 5,5	48,43*	25 x 9	38,25*	
M 10x0,50	2	9,50	63 x 18 x 5,5	59,10	30 x 10	129,87	
M 10x0,75	2	9,25	63 x 18 x 5,5	60,43	30 x 11	63,85	
M 10x1,00	2	9,00	63 x 18 x 5,5	29,23	38 x 10	42,34	
M 10x1,25	2	8,80	70 x 24 x 5,5	29,63	38 x 10	45,16	
M 10x1,50	3	8,50	70 x 24 x 5,5	36,45*	38 x 10	44,05*	
M 11x0,75	2	10,25	63 x 18 x 6,2	88,73	30 x 11	140,31	
M 11x1,00	2	10,00	63 x 18 x 6,2	55,90	30 x 11	66,82	
M 11x1,25	2	9,75	63 x 20 x 6,2	55,90	30 x 11	66,81	
M 11x1,50	3	9,50	70 x 24 x 6,2	60,76	38 x 10	53,37	
M 12x0,75	2	11,25	70 x 20 x 7,0	80,68	38 x 10	72,45	
M 12x1,00	2	11,00	70 x 20 x 7,0	51,83	38 x 10	63,85	
M 12x1,25	2	10,75	70 x 20 x 7,0	51,68	38 x 10	61,56	
M 12x1,50	2	10,50	70 x 20 x 7,0	44,03*	38 x 10	55,21*	
M 12x1,75	3	10,20	75 x 29 x 7,0	51,28*	38 x 14	47,86*	
M 13x0,75	2	12,25	70 x 20 x 9,0	91,18	38 x 10	127,74	
M 13x1,00	2	12,00	70 x 20 x 9,0	87,78	38 x 10	67,84	
M 13x1,25	2	11,75	70 x 20 x 9,0	80,13	38 x 10	90,71	
M 13x1,50	2	11,50	70 x 20 x 9,0	80,13	38 x 10	71,31	
M 13x1,75	3	11,25	70 x 20 x 9,0	92,72	38 x 14	76,41	
M 14x0,75	2	13,25	70 x 20 x 9,0	104,78	38 x 10	119,77	
M 14x1,00	2	13,00	70 x 20 x 9,0	80,78	38 x 10	71,61	
M 14x1,25	2	12,80	70 x 20 x 9,0	63,10*	38 x 10	71,61*	
M 14x1,50	2	12,50	70 x 20 x 9,0	49,07	38 x 10	60,96	
M 14x1,75	2	12,25	70 x 20 x 9,0	98,13	38 x 14	203,96	
M 14x2,00	3	12,00	80 x 30 x 9,0	56,73*	38 x 14	47,39*	
M 15x1,00	2	14,00	70 x 20 x 9,0	113,18	45 x 14	77,11	
M 15x1,25	2	13,75	70 x 20 x 9,0	117,27	45 x 14	119,46	
M 15x1,50	2	13,50	70 x 20 x 9,0	104,99	45 x 14	82,61	
M 15x2,00	3	13,00	80 x 30 x 9,0	113,43	45 x 14	103,55	
M 16x1,00	2	15,00	70 x 20 x 9,0	107,16	45 x 14	87,31	
M 16x1,25	2	14,75	70 x 20 x 9,0	112,80	45 x 14	73,46	
M 16x1,50	2	14,50	70 x 20 x 9,0	61,06*	45 x 14	68,58*	
M 16x2,00	3	14,00	80 x 32 x 9,0	81,17*	45 x 18	64,25*	
M 17x1,00	2	16,00	70 x 20 x 9,0	173,07	45 x 14	124,94	
M 17x1,25	2	15,75	70 x 20 x 9,0	173,07	45 x 14	124,94	
M 17x1,50	2	15,50	70 x 20 x 9,0	173,07	45 x 14	124,94	
M 18x1,00	2	17,00	80 x 22 x 11,0	119,14	45 x 14	92,32	
M 18x1,25	2	16,75	80 x 22 x 11,0	170,07	45 x 14	96,02	

* Consulte el precio de machos y terrajas a izquierdas disponibles en Pag.188

* Recargo por cojinetes abiertos 20% sobre los precios tarifados

JUEGOS DE MACHOS Y TERRAJAS PARA ROSCAR A MANO HSS

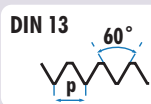

Ref. M0

	(M)	(MF)	
HSS	DIN 352	DIN 2181	TOL 6H

Ref. C5

HSS	DIN 223	TOL 6g
-----	---------	--------

			M0			C5						M0			C5		
	Uds.	Ø	L1 x L2 x mm	€	Ø x L3 mm	€		Uds.	Ø	L1 x L2 x mm	€	Ø x L3 mm	€	Ø x L3 mm	€		
M 18x1,50	2	16,50	80 x 22 x 11,0	80,44	45 x 14	83,06	M 33x3,50	3	29,5	125 x 50 x 20,0	390,08*	65 x 25	147,36*				
M 18x2,00	2	16,00	80 x 22 x 11,0	128,40*	45 x 14	92,80*	M 34x1,50	2	32,5	100 x 25 x 22,0	400,85	65 x 18	168,65				
M 18x2,50	3	15,50	95 x 40 x 11,0	107,13*	45 x 18	64,28*	M 34x2,00	2	32,0	100 x 25 x 22,0	479,38	65 x 18	384,96				
M 19x1,00	2	18,00	80 x 22 x 11,0	251,18	45 x 14	154,96	M 35x1,50	2	33,5	100 x 25 x 22,0	427,97	65 x 18	174,93				
M 19x1,25	2	17,75	80 x 22 x 11,0	251,18	45 x 14	175,26	M 35x2,00	2	33,0	100 x 25 x 22,0	479,38	65 x 18	300,20				
M 19x1,50	2	17,50	80 x 22 x 11,0	251,18	45 x 14	154,96	M 36x1,50	2	34,5	100 x 25 x 22,0	417,83	65 x 18	165,60				
M 19x2,00	2	17,00	80 x 22 x 11,0	298,17	45 x 14	177,03	M 36x2,00	2	34,0	125 x 33 x 22,0	550,33	65 x 18	172,71				
M 20x1,00	2	19,00	80 x 22 x 12,0	162,19	45 x 14	92,32	M 36x3,00	2	33,0	125 x 33 x 22,0	713,13*	65 x 25	173,28*				
M 20x1,25	2	18,75	80 x 22 x 12,0	250,26	45 x 14	200,36	M 36x4,00	3	32,0	150 x 53 x 22,0	502,21*	65 x 25	150,23*				
M 20x1,50	2	18,50	80 x 22 x 12,0	100,74	45 x 14	84,98	M 38x1,50	2	36,5	100 x 25 x 22,0	482,93	75 x 20	253,02				
M 20x2,00	2	18,00	80 x 22 x 12,0	136,00*	45 x 14	92,32*	M 38x2,00	2	36,0	125 x 25 x 22,0	649,97	75 x 20	373,86				
M 20x2,50	3	17,50	95 x 40 x 12,0	120,18*	45 x 18	63,27*	M 39x1,50	2	37,5	110 x 25 x 24,0	639,19	75 x 20	251,67				
M 21x1,00	2	20,00	80 x 22 x 12,0	321,81	45 x 14	189,84	M 39x2,00	2	37,0	125 x 23 x 24,0	639,19	75 x 20	265,78				
M 21x1,25	2	19,75	80 x 22 x 12,0	321,81	45 x 14	189,84	M 39x3,00	2	36,0	125 x 33 x 24,0	616,56*	75 x 30	271,46*				
M 21x1,50	2	19,50	80 x 22 x 12,0	250,52	45 x 14	200,68	M 39x4,00	3	35,0	150 x 53 x 24,0	561,94*	75 x 30	228,51*				
M 22x1,00	2	21,00	80 x 22 x 14,5	181,77	55 x 16	124,27	M 40x1,50	2	38,5	110 x 25 x 24,0	567,12	75 x 20	264,37				
M 22x1,25	2	20,75	80 x 22 x 14,5	247,85	55 x 16	202,51	M 40x2,00	2	38,0	125 x 33 x 24,0	624,51	75 x 20	245,49				
M 22x1,50	2	20,50	80 x 22 x 14,5	110,80	55 x 16	106,90	M 40x3,00	2	37,0	125 x 33 x 24,0	622,22	75 x 30	267,74				
M 22x2,00	2	20,00	80 x 22 x 14,5	176,74*	55 x 16	118,94*	M 42x1,50	2	40,5	110 x 25 x 24,0	616,44	75 x 20	293,95				
M 22x2,50	3	19,50	100 x 40 x 14,5	160,08*	55 x 22	95,08*	M 42x2,00	2	40,0	125 x 33 x 24,0	730,75	75 x 20	310,82				
M 23x1,00	2	22,00	80 x 22 x 14,5	324,61	55 x 16	205,35	M 42x3,00	2	39,0	125 x 33 x 24,0	733,90	75 x 30	293,95				
M 23x1,50	2	21,50	80 x 22 x 14,5	323,35	55 x 16	243,45	M 42x4,50	3	37,5	150 x 53 x 24,0	703,09	75 x 30	228,49				
M 24x1,00	2	23,00	90 x 22 x 14,5	196,13	55 x 16	121,20	M 45x1,50	2	43,5	110 x 25 x 29,0	673,32	90 x 22	343,49				
M 24x1,25	2	22,75	90 x 22 x 14,5	320,56	55 x 16	160,91	M 45x2,00	2	43,0	125 x 33 x 29,0	877,59	90 x 22	372,89				
M 24x1,50	2	22,50	90 x 22 x 14,5	141,24	55 x 16	108,92	M 45x3,00	2	42,0	125 x 33 x 29,0	877,59	90 x 36	389,06				
M 24x2,00	2	22,00	90 x 22 x 14,5	210,75*	55 x 16	121,20*	M 45x4,50	3	40,5	160 x 60 x 29,0	811,67	90 x 36	354,06				
M 24x3,00	3	21,00	110 x 50 x 14,5	190,94*	55 x 22	95,08*	M 48x1,50	2	46,5	140 x 33 x 29,0	751,72	90 x 22	335,65				
M 25x1,00	2	24,00	90 x 22 x 14,5	276,69	55 x 16	183,94	M 48x2,00	2	46,0	140 x 33 x 29,0	1.146,95	90 x 22	367,66				
M 25x1,25	2	23,75	90 x 22 x 14,5	362,36	55 x 16	242,19	M 48x3,00	2	45,0	140 x 33 x 29,0	1.063,46	90 x 36	354,68				
M 25x1,50	2	23,50	90 x 22 x 14,5	261,04	55 x 16	158,22	M 48x5,00	3	43,0	180 x 65 x 29,0	977,24	90 x 36	354,48				
M 25x2,00	2	23,00	90 x 22 x 14,5	471,88	55 x 16	235,47	M 50x1,50	2	48,5	140 x 33 x 29,0	822,10	90 x 22	350,00				
M 26x1,00	2	25,00	90 x 22 x 14,5	247,33	55 x 16	182,31	M 50x3,00	2	57,0	140 x 33 x 29,0	1.097,87	90 x 22	381,44				
M 26x1,50	2	24,50	90 x 22 x 14,5	232,06	55 x 16	146,98	M 52x1,50	2	50,5	140 x 33 x 32,0	862,35	90 x 22	357,40				
M 26x2,00	2	24,00	90 x 22 x 14,5	272,28	55 x 16	206,02	M 52x2,00	2	50,0	140 x 33 x 32,0	1.251,19	90 x 22	415,35				
M 27x1,00	2	26,00	90 x 22 x 16,0	272,30	65 x 18	164,00	M 52x3,00	2	49,0	140 x 33 x 32,0	1.151,95	90 x 36	453,25				
M 27x1,50	2	25,50	90 x 22 x 16,0	262,92	65 x 18	164,70	M 52x5,00	3	47,0	180 x 65 x 32,0	1.170,45	90 x 36	354,48				
M 27x2,00	2	25,00	90 x 22 x 16,0	292,08*	65 x 18	179,13*	M 56x4,00	2	52,0	180 x 47 x 32,0	1.284,50	105 x 36					
M 27x3,00	3	24,00	110 x 50 x 16,0	241,45*	65 x 25	144,22*	M 56x5,50	3	50,5	200 x 85 x 35,0	1.816,67	105 x 36					
M 28x1,00	2	27,00	90 x 22 x 16,0	459,59	65 x 18	212,00	M 60x5,50	3	54,5	200 x 85 x 35,0	1.887,89	105 x 36					
M 28x1,50	2	26,50	90 x 22 x 16,0	257,79	65 x 18	149,31	M 64x4,00	2	60,0	180 x 50 x 35,0	1.809,03	120 x 36					
M 28x2,00	2	26,00	90 x 22 x 16,0	308,43	65 x 18	209,93	M 64x6,00	3	58,0	220 x 90 x 39,0	2.233,84	120 x 36					
M 30x1,00	2	29,00	90 x 22 x 18,0	286,27	65 x 18	173,80	M 68x6,00	3	62,0	220 x 90 x 39,0	2.674,33	120 x 36					
M 30x1,50	2	28,50	90 x 22 x 18,0	274,73	65 x 18	164,69	M 72x6,00	3	66,0	235 x 90 x 39,0	2.897,34	120 x 36					
M 30x2,00	2	28,00	90 x 22 x 18,0	316,74	65 x 18	182,52											
M 30x3,00	2	27,00	125 x 56 x 18,0	309,64*	65 x 25	203,31*											
M 30x3,50	3	26,50	125 x 50 x 18,0	310,65*	65 x 25	144,59*											
M 32x1,00	2	31,00	90 x 22 x 18,0	377,52	65 x 18	224,48											
M 32x1,50	2	30,50	90 x 22 x 18,0	327,12	65 x 18	170,81											
M 32x2,00	2	30,00	90 x 22 x 18,0	468,23	65 x 18	208,05											
M 33x1,00	2	32,00	100 x 25 x 20,0	602,47	65 x 18	237,69											
M 33x1,50	2	31,50	100 x 25 x 20,0	349,86	65 x 18	161,63											
M 33x2,00	2	31,00	100 x 25 x 20,0	441,71	65 x 18	162,74											
M 33x3,00	2	30,00	125 x 56 x 20,0	557,35*	65 x 25	251,14*											

COJINETES CON MEDIDA EXTERIOR EN PULGADAS

	Ø x L3 mm	€		Ø x L3 mm	€
M 3x0,50	25,4 x 9,5	26,59	M 8x1,25	38,1 x 12,7	28,22
M 4x0,70	25,4 x 9,5	26,59	M 10x1,50	25,4 x 9,50	35,72
M 5x0,80	25,4 x 9,5	27,09	M 10x1,50	38,1 x 12,7	35,72
M 6x1,00	25,4 x 9,5	26,59	M 12x1,75	25,4 x 9,50	43,04
M 8x1,25	25,4 x 9,5	28,22	M 12x1,75	38,1 x 12,7	43,04

* Consulte el precio de machos y terrajas a izquierdas disponibles en Pag.188

* Recargo por cojinetes abiertos 20% sobre los precios tarifados

JUEGOS DE MACHOS Y TERRAJAS PARA ROSCAR A MANO HSS
UNC

Ref. M0

HSS

DIN
351TOL
2B

Ref. C5

HSS

DIN
223TOL
2a
UNF

Ref. M0

HSS

DIN
2181TOL
2B

Ref. C5

HSS

DIN
223TOL
2a

	Uds.	D1 mm		M0		C5			Uds.	D1 mm		M0		C5	
				L1 x L2 x mm	€	Ø x L3 mm	€					L1 x L2 x mm	€	Ø x L3 mm	€
UNC n°1-64h.	3	1,85	1,50	36x8x2,1	113,74	16x5		UNF n°2-64h.	2	2,18	1,85	36x8x2,1	72,83		
UNC n°2-56h.	3	2,18	1,80	36x9x2,1	80,38	16x5		UNF n°3-56h.	2	2,51	2,15	40x9x2,1	72,83		
UNC n°3-48h.	3	2,51	2,10	40x9x2,1	80,38	16x5		UNF n°4-48h.	2	2,84	2,35	40x9x2,7	45,38	20x5	46,94
UNC n°4-40h.	3	2,84	2,25	40x11x2,7	60,87	20x5	45,17	UNF n°5-44h.	2	3,17	2,70	45x10x2,7	45,38	20x5	45,29
UNC n°5-40h.	3	3,17	2,60	40x11x2,7	58,20	20x5	45,29	UNF n°6-40h.	2	3,50	2,95	45x16x3,0	43,37	20x5	45,29
UNC n°6-32h.	3	3,50	2,75	45x13x3,0	58,20	20x7	45,29	UNF n°8-36h.	2	4,17	3,50	50x12x3,4	43,37	20x7	45,29
UNC n°8-32h.	3	4,17	3,50	45x13x3,4	58,20	20x7	45,29	UNF n°10-32h.	2	4,83	4,10	50x12x4,9	43,37	20x7	45,29
UNC n°10-24h.	3	4,83	3,90	50x16x4,9	58,20	20x7	45,29	UNF n°12-28h.	2	5,49	4,60	50x12x4,9	45,38	20x7	45,29
UNC n°12-24h.	3	5,49	4,50	50x19x4,9	58,20	20x7	45,29	UNF 1/4-28h.	2	6,35	5,50	50x14x4,9	33,10*	25x9	39,98*
UNC 1/4-20h.	3	6,35	5,10	50x19x4,9	49,87*	20x7	42,68*	UNF 5/16-24h.	2	7,94	6,90	56x22x4,9	35,44*	25x9	44,63*
UNC 5/16-18h.	3	7,94	6,60	56x22x4,9	56,62*	25x9	43,80*	UNF 3/8-24h.	2	9,52	8,50	63x20x5,5	40,92*	38x10	60,89*
UNC 3/8-16h.	3	9,52	8,00	70x24x5,5	64,42*	30x11	60,89*	UNF 7/16-20h.	2	11,11	9,90	63x20x6,2	54,30	38x10	59,74
UNC 7/16-14h.	3	11,11	9,40	70x24x6,2	83,88	38x14	60,89	UNF 1/2-20h.	2	12,70	11,50	70x22x7,0	55,56*	38x10	65,09*
UNC 1/2-13h.	3	12,70	10,75	75x29x7,0	96,51*	38x14	62,59*	UNF 9/16-18h.	2	14,29	12,90	70x22x9,0	72,40	38x10	68,13
UNC 9/16-12h.	3	14,28	12,20	80x30x9,0	113,94	38x14	65,51	UNF 5/8-18h.	2	15,87	14,50	70x22x9,0	93,52*	45x14	88,80*
UNC 5/8-11h.	3	15,87	13,50	80x32x9,0	157,14*	45x18	88,80*	UNF 3/4-16h.	2	19,05	17,50	80x22x11,0	125,62*	45x14	88,80*
UNC 3/4-10h.	3	19,05	16,50	95x40x11,0	214,11*	45x18	88,80*	UNF 7/8-14h.	2	22,22	20,40	80x22x14,5	161,44*	55x16	119,19*
UNC 7/8-9h.	3	22,22	19,50	100x40x14,5	263,57	55x22	123,97	UNF 1"-12h.	2	25,40	23,25	90x22x16,0	214,06	55x16	119,19
UNC 1"-8h.	3	25,40	22,25	110x50x14,5	355,91*	55x22	119,19*	UNF 1"-14h.	2	25,40	23,60	90x22x14,5	237,14*	55x16	129,51*
UNC 1.1/8-7h.	3	28,57	25,00	125x56x18,0	536,62	65x25	177,06	UNF 1.1/8-12h.	2	28,57	26,50	90x22x18,0	315,95	65x18	145,16
UNC 1.1/4-7h.	3	31,75	28,00	125x56x18,0	675,44	65x25	177,06	UNF 1.1/4-12h.	2	31,75	29,50	90x22x20,0	385,87	65x18	184,14
UNC 1.3/8-6h.	3	34,92	30,75	150x63x22,0	856,88	65x25	177,06	UNF 1.3/8-12h.	2	34,92	32,80	125x35x22,0	520,58	65x18	192,76
UNC 1.1/2-6h.	3	38,10	34,00	150x63x24,0	1.052,07	75x30	276,06	UNF 1.1/2-12h.	2	38,10	36,00	125x40x22,0	657,67	75x20	276,06
UNC 2"-4,5h.	3	50,80	45,00	180x75x32,0	1.430,05	90x36		UNF 2"-12h.	2	50,80	48,38	140x40x29,0	1.627,34	90x22	

JUEGOS DE MACHOS Y TERRAJAS PARA ROSCAR A MANO HSS

BSP (GAS) Ref. MO **DIN 5157 TOL ISO 228** Ref. C5 **DIN 5158** Ref. MOT Ref. MOX **DIN 5157 TOL 6H** Ref. C5T Ref. C5X **DIN 5158 TOL 6g**



Icon	Uds.	D1 mm	Ø	L1 x L2 x mm	MO		C5		Icon	Uds.	MOT		C5T		MOX		C5X	
					HSS	€	HSS	€			HSS	€	TiN	€	HSS	€	HSSCo	OX
G 1/8-28h.	2	9,73	8,80	63 x 20 x 5,5	37,01*	38 x 10	54,45*	G 1/8-28 h.	2	80,55	101,51	92,55	69,02					
G 1/4-19h.	2	13,16	11,80	70 x 22 x 9,0	52,16*	38 x 10	54,16*	G 1/4-19 h.	2	146,54	105,05	166,30	71,19					
G 3/8-19h.	2	16,66	15,25	70 x 22 x 9,0	65,48*	45 x 14	71,73*	G 3/8-19 h.	2	178,79	118,17	206,59	84,69					
G 1/2-14h.	2	20,95	19,00	80 x 22 x 12,0	91,83*	45 x 14	71,73*	G 1/2-14 h.	2	251,98	133,77	278,74	93,71					
G 5/8-14h.	2	22,91	21,00	80 x 22 x 14,5	117,50*	55 x 16	99,51*											
G 3/4-14h.	2	26,44	24,50	90 x 22 x 16,0	143,35*	55 x 16	129,53*	G 3/4-14 h.	2	330,58	217,94	400,09	159,84					
G 7/8-14h.	2	30,20	28,25	90 x 22 x 18,0	192,98	65 x 18	154,20											
G 1"-11h.	2	33,25	30,75	100 x 25 x 20,0	227,25*	65 x 18	155,69*	G 1" -11 h.	2	576,15	291,11	658,06	190,95					
G 1.1/8-11h.	2	37,90	35,50	125 x 40 x 22,0	362,65	75 x 20	219,74											
G 1.1/4-11h.	2	41,91	39,50	125 x 40 x 24,0	395,20*	75 x 20	215,70*											
G 1.3/8-11h.	2	44,32	42,00	125 x 40 x 29,0	536,77	90 x 22	338,02											
G 1.1/2-11h.	2	47,80	45,25	140 x 40 x 29,0	597,26	90 x 22	325,60											
G 1.3/4-11h.	2	53,75	51,25	140 x 40 x 32,0	992,93	105 x 22	338,02											
G 2"-11h.	2	59,61	57,00	160 x 40 x 35,0	1.104,06	105 x 22	406,80											
G 2.1/4-11h.	2	65,71	63,00	160 x 40 x 39,0	1.823,79	105 x 22												
G 2.1/2-11h.	2	75,18	72,50	160 x 40 x 39,0	2.741,36	120 x 22												
G 2.3/4-11h.	2	81,53	79,00	160 x 40 x 39,0	3.324,15	120 x 22												
G 3"-11h.	2	87,88	85,50	160 x 40 x 39,0	3.459,76	150 x 25												
G 4"-11h.	2	113,03	110,50	180 x 45 x 44,0	5.247,27	180 x 25												

UNF 3B Ref. MO **HSS** **DIN 2181** **TOL 3B**

Icon	Uds.	D1 mm	Ø	L1 x L2 x mm	MO-3B	€
UNF n°4-48-3B	2	2,84	2,35	40x9x2,7	57,80	
UNF n°5-44-3B	2	3,17	2,70	45x10x2,7	57,80	
UNF n°6-40-3B	2	3,50	2,95	45x16x3,0	54,53	
UNF n°8-36-3B	2	4,17	3,50	50x12x3,4	54,53	
UNF n°10-32-3B	2	4,83	4,10	50x12x4,9	54,53	
UNF n°12-28-3B	2	5,49	4,60	50x12x4,9	57,80	
UNF 1/4-28-3B	2	6,35	5,50	50x14x4,9	42,16	
UNF 5/16-24-3B	2	7,94	6,90	56x22x4,9	45,13	
UNF 3/8-24-3B	2	9,52	8,50	63x20x5,5	52,11	
UNF 7/16-20-3B	2	11,11	9,90	63x20x6,2	69,17	
UNF 1/2-20-3B	2	12,70	11,50	70x22x7,0	70,76	

* Consulte el precio de machos y terrajas a izquierdas disponibles en Pag.188

Machos y Terrajas
Verde Rosa

JUEGOS DE MACHOS Y TERRAJAS PARA ROSCAR A MANO HSS

Machos y Terrajas

Rosa Verde

BSW

Ref. M0

HSS

DIN 351

TOL Clase 2

Ref. C5

HSS

DIN 223

DIN BS84 55°

BSF

Ref. M0

HSS

DIN 5157

TOL ISO 228

Ref. C5

HSS

DIN 223

DIN BS84 55°

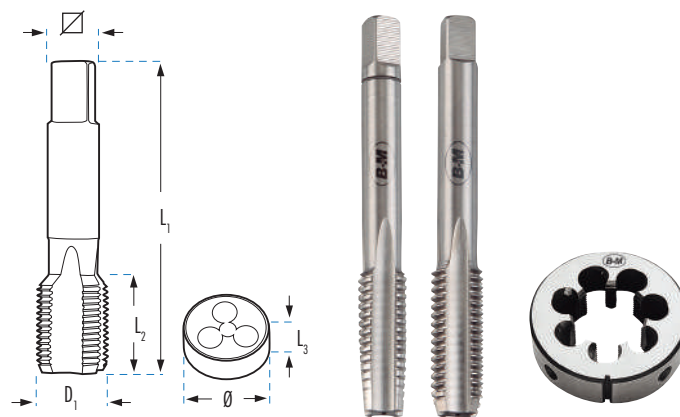

Icon	Uds.	D1 mm	Ø	M0		C5	
				L1 x L2 x mm	€	Ø x L3 mm	€
W 1/16-60h.	3	1,59	1,15	32x8x2,1	62,53	16x5	84,15
W 3/32-48h.	3	2,38	1,80	40x9x2,1	45,72	20x5	43,42
W 1/8-40h.	3	3,17	2,55	40x14x2,7	32,84*	25x9	34,27*
W 5/32-32h.	3	3,97	3,10	45x17x3,4	33,18	25x9	34,96
W 3/16-24h.	3	4,76	3,60	50x19x4,9	32,84	25x9	34,27
W 7/32-24h.	3	5,55	4,40	50x19x4,9	54,01	25x9	44,76
W 1/4-20h.	3	6,35	5,10	50x20x4,9	36,99*	25x9	34,96*
W 5/16-18h.	3	7,94	6,50	56x20x4,9	45,18*	25x9	36,46*
W 3/8-16h.	3	9,52	7,90	63x22x5,5	49,64*	38x10	52,77*
W 7/16-14h.	3	11,11	9,25	70x22x6,2	66,63	38x10	52,84
W 1/2-12h.	3	12,70	10,50	75x25x7,0	71,50	38x14	51,85
W 9/16-12h.	3	14,29	12,00	80x26x9,0	97,27	38x14	63,32
W 5/8-11h.	3	15,87	13,40	80x27x9,0	111,86*	45x18	75,30*
W 11/16-11h.	3	17,46	15,25	95x32x11,0	263,61	45x18	124,04
W 3/4-10h.	3	19,05	16,50	95x32x11,0	159,24*	45x18	75,42*
W 7/8-9h.	3	22,22	19,25	100x32x14,5	217,47*	55x22	110,89*
W 1"- 8h.	3	25,40	21,75	110x36x14,5	266,51*	55x22	111,90*
W 1.1/8-7h.	3	28,57	24,75	125x40x18,0	395,03	65x25	176,20
W 1.1/4-7h.	3	31,75	27,75	125x40x18,0	477,94	65x25	176,27
W 1.3/8-6h.	3	34,92	30,50	150x50x22,0	594,34	65x25	179,53
W 1.1/2-6h.	3	38,10	33,50	150x50x24,0	715,56	75x30	272,90
W 1.5/8-5h.	3	41,27	46,50	150x56x24,0	996,00	75x30	339,81
W 1.3/4-5h.	3	44,45	39,00	160x58x29,0	1.225,84	90x36	427,66
W 1.7/8-4,5h.	3	47,62	42,00	180x65x29,0	1.583,24	90x36	467,95
W 2"- 4,5h.	3	50,80	44,50	180x65x32,0	1.662,13	90x36	490,41
W 2.1/4-4h.	3	57,15	50,00	200x85x35,0	2.754,08	105x36	
W 2.1/2-4h.	3	63,50	56,50	220x85x39,0	3.350,38	120x36	
W 2.3/4-3,5h.	3	69,85	62,00	250x90x44,0	4.783,95	120x36	
W 3"- 3,5h.	3	76,20	68,00	250x90x44,0	5.534,50	140x36	

Icon	Uds.	D1 mm	Ø	M0		C5	
				L1 x L2 x mm	€	Ø x L3 mm	€
BSF 3/16-32h.	2	4,76	4,0	50x19x4,9	89,99	20x7	45,09
BSF 1/4-26h.	2	6,35	5,2	50x20x4,9	50,26	20x7	49,93
BSF 5/16-22h.	2	7,94	6,6	56x20x4,9	58,61	25x9	50,50
BSF 3/8-20h.	2	9,52	8,1	63x22x5,5	67,83	30x11	97,01
BSF 7/16-18h.	2	11,11	9,5	70x22x6,2	81,39	30x11	96,11
BSF 1/2-16h.	2	12,70	11,0	75x25x7,0	92,08	38x10	83,87
BSF 9/16-16h.	2	14,29	12,5	80x26x9,0	110,37	38x10	88,51
BSF 5/8-14h.	2	15,88	14,0	80x26x9,0	144,44	45x14	137,98
BSF 3/4-12h.	2	19,05	16,5	95x33x11,0	220,77	45x14	139,26
BSF 7/8-11h.	2	22,23	19,5	100x33x14,5	263,50	55x22	186,75
BSF 1"-10h.	2	25,40	22,5	110x40x14,5	369,88	55x22	184,68
BSF 1.1/8-9h.	2	28,57	25,5	110x40x16,0	834,60		
BSF 1.1/4-9h.	2	31,75	28,5	125x46x18,0	952,85		
BSF 1.1/2-8h.	2	38,10	34,5	150x55x22,0	1.452,21		

BSW **INOX** **TiN**

Icon	Uds.	L1 x L2 x mm	M0T		C5T	
			€	Ø x L3 mm	€	
W 3/16-24 h.	3	50 x 19 x 4,90	62,70	25x9	62,67	
W 1/4-20 h.	3	50 x 20 x 4,90	70,18	25x9	63,82	
W 5/16-18 h	3	56 x 20 x 4,90	76,90	25x9	66,34	
W 3/8-16 h.	3	63 x 22 x 5,50	90,51	38x10	78,42	
W 1/2-12 h.	3	75 x 25 x 7,00	127,72	38x14	105,36	





* Consulte el precio de machos y terrajas a izquierdas disponibles en Pag.188

MACHOS Y TERRAJAS PARA ROSCAR A MANO HSS

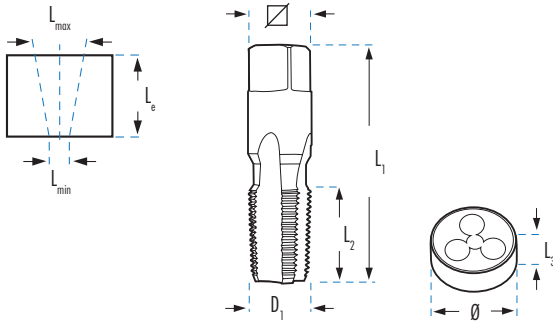



NPTF  Rosca AMERICANA
Rosca Cónica estanca Ref. M0 **HSS** Ref. C5 **HSS** **DIN 223**

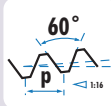

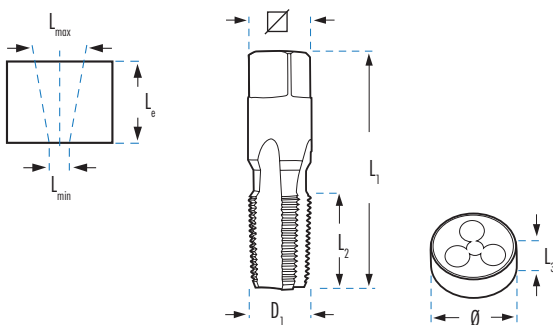
		Uds.	D1 mm		L min x L max mm	L _e mm	L1 x L2 x ∇ mm	€	Ø x L3 mm	€
NPTF 1/8-27 h.		1	10,22	8,5	8,30 x 8,76	12,0	54 x 19 x 8,0	100,75	38 x 10	220,02
NPTF 1/4-18 h.		1	13,58	11,0	10,70 x 11,40	17,5	62 x 27 x 11,0	141,21	38 x 15	220,02
NPTF 3/8-18 h.		1	17,02	14,5	14,20 x 14,84	17,6	65 x 27 x 13,0	194,93	45 x 14	287,28
NPTF 1/2-14 h.		1	21,21	17,8	17,40 x 18,33	22,8	80 x 35 x 13,0	272,58	45 x 20	287,28
NPTF 3/4-14 h.		1	26,56	23,0	22,80 x 23,68	23,0	83 x 35 x 17,0	416,66	55 x 22	547,53
NPTF 1"-11,5 h.		1	33,19	29,0	28,60 x 29,72	27,4	110 x 38 x 20,0	554,99		

NPT  Rosca AMERICANA
Rosca Cónica no estanca (Briggs) Ref. M0 **HSS** Ref. C5 **HSS** **DIN 223**





		Uds.	D1 mm			L min x L max mm	L _e mm	L1 x L2 x ∇ mm	€	Ø x L3 mm	€
NPT 1/16-27 h.		1	7,89	6,20	EMNPT1/16	6,00 x 6,38	12,0	54 x 18 x 6,0	38,25	25 x 9	126,47
NPT 1/8-27 h.		1	10,24	8,50	EMNPT1/8	8,30 x 8,73	12,0	65 x 19 x 5,5	38,25	30 x 11	93,51
NPT 1/4-18 h.		1	13,62	11,00	EMNPT1/4	10,70 x 11,35	17,5	62 x 27 x 11,0	53,67	38 x 14	93,51
NPT 3/8-18 h.		1	17,05	14,50	EMNPT3/8	14,20 x 14,80	17,6	65 x 27 x 13,0	74,07	45 x 18	122,08
NPT 1/2-14 h.		1	21,23	17,80	EMNPT1/2	17,40 x 18,32	22,8	80 x 35 x 13,0	103,57	45 x 18	122,08
NPT 3/4-14 h.		1	26,57	23,00	-	22,80 x 23,66	23,0	83 x 35 x 17,0	158,33	55 x 22	223,32
NPT 1"-11,5 h.		1	33,23	29,00	-	28,60 x 29,69	27,4	95 x 44 x 21,0	176,34	65 x 25	268,47
NPT 1.1/4-11,5 h.		1	41,98	37,50	-	37,40 x 38,45	28,1	125 x 33 x 24,0	289,12	75 x 26	333,62
NPT 1.1/2-11,5 h.		1	48,05	44,00	-	43,40 x 44,52	28,4	140 x 33 x 29,0	439,33	90 x 27	465,46
NPT 2"-11,5 h.		1	60,09	56,00	-	55,50 x 56,56	28,4	160 x 33 x 35,0	685,88	105 x 36	648,03
NPT 2.1/2"-8h.		1	73,03	67,00	-	68,68 x 69,08	28,9	200 x 45 x 39,0	838,07		
NPT 3"-8h.		1	88,90	82,00	-	84,45 x 84,86	30,5	220 x 48 x 39,0	1.178,01		

* Ver escariador previo pag.137

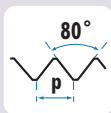
MACHOS Y TERRAJAS PARA ROSCAR A MANO HSS



PG  Ref. MO **HSS** **DIN 40430** Ref. C5 **HSS** **DIN 223**

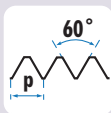

		Uds.	D1 mm		L1 x L2 x L3 mm	MO		C5	
						€	Ø x L3 mm	€	€
Pg 7	20h.	1	12,5	11,50	70x20x7,0	36,68	38x10	67,44	67,44
Pg 9	18h.	1	15,2	14,00	70x20x9,0	46,63	38x10	67,44	67,44
Pg 11	18h.	1	18,6	17,25	80x22x11,0	64,75	45x14	84,44	84,44
Pg 13,5	18h.	1	20,4	19,00	80x22x12,0	71,00	45x14	84,44	84,44
Pg 16	18h.	1	22,5	21,25	80x22x14,5	85,27	55x16	108,93	108,93
Pg 21	16h.	1	28,3	27,00	90x22x18,0	125,39	65x18	154,84	154,84
Pg 29	16h.	1	37,0	35,50	100x25x22,0	248,98	65x18	154,84	154,84
Pg 36	16h.	1	47,0	45,50	140x32x29,0	408,60	90x22	396,87	396,87
Pg 42	16h.	1	54,0	52,50	140x36x32,0	485,24	105x22	396,87	396,87
Pg 48	16h.	1	59,3	58,00	160x36x35,0	611,98	105x22	526,29	526,29

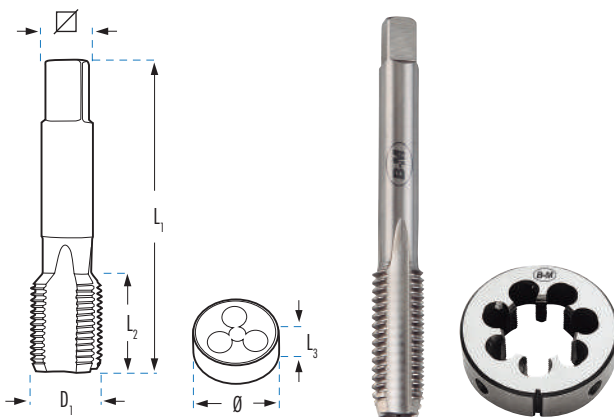

NPSF  Rosca AMERICANA
Rosca Cilíndrica estanca Ref. MO **HSS** Ref. C5 **HSS** **DIN 223**

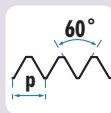

		Uds.	D1 mm		L1 x L2 x L3 mm	MO		C5	
						€	Ø x L3 mm	€	€
NPSF 1/8-27 h.	1	10,05	8,75	63x18x5,5	151,72	38x10	264,30	264,30	
NPSF 1/4-18 h.	1	13,35	11,30	70x20x9,0	219,24	38x10	264,30	264,30	
NPSF 3/8-18 h.	1	16,78	14,70	70x20x9,0	303,25	45x14	336,22	336,22	
NPSF 1/2-14 h.	1	20,87	18,20	80x22x12,0	396,43	45x14	336,22	336,22	
NPSF 3/4-14 h.	1	26,23	23,50	90x22x16,0	603,18	55x16	726,76	726,76	

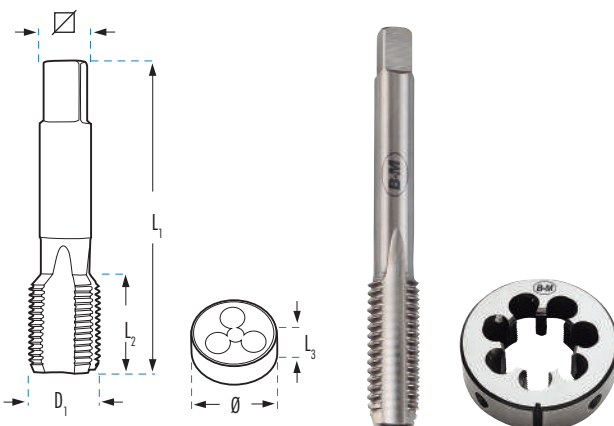
NPS (M)  Rosca AMERICANA
Rosca Cilíndrica no estanca Ref. MO **HSS** Ref. C5 **HSS** **DIN 223**





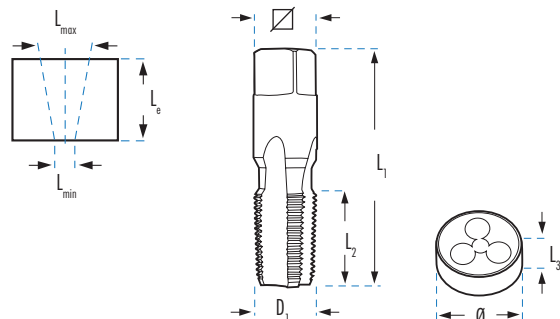

		Uds.	D1 mm		L1 x L2 x L3 mm	MO		C5	
						€	Ø x L3 mm	€	€
NPS 1/8-27 h.	1	10,20	8,9	63x18x5,5	125,71	38x10	220,19	220,19	
NPS 1/4-18 h.	1	13,60	11,7	70x20x9,0	100,04	38x10	220,19	220,19	
NPS 3/8-18 h.	1	17,00	15,0	70x20x9,0	138,37	45x14	280,17	280,17	
NPS 1/2-14 h.	1	21,20	18,6	80x22x12,0	180,86	45x14	280,17	280,17	
NPS 3/4-14 h.	1	26,55	24,0	90x22x16,0	262,64	55x16	555,02	555,02	
NPS 1"-11,5 h.	1	33,20	30,0	100x25x20,0	367,24	65x18	559,34	559,34	

JUEGOS DE MACHOS Y TERRAJAS PARA ROSCAR A MANO HSS





BSPT  Ref. MO **HSS** **DIN 5157** Ref. C5 **HSS** **DIN 223**

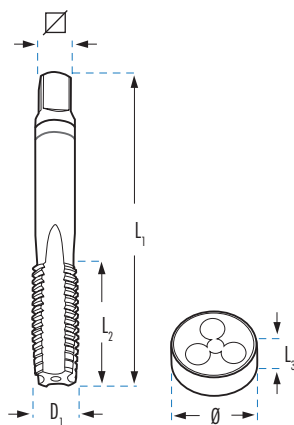

		Uds.	D1 mm		L min x L max mm	L _e mm	L1 x L2 x 	MO	C5
								€	Ø x L3 mm
BSPT 1/8-28 h.		1	9,73	8,30	8,00 x 8,50	10,1	65 x 19 x 5,5	34,25	30 x 11 102,09
BSPT 1/4-19 h.		1	13,16	11,00	10,70 x 11,35	15,0	70 x 25 x 9,0	48,26	38 x 14 102,09
BSPT 3/8-19 h.		1	16,66	14,50	14,15 x 14,25	15,4	70 x 25 x 9,0	67,01	45 x 16 132,96
BSPT 1/2-14 h.		1	20,95	18,10	17,60 x 18,50	20,5	80 x 31 x 12,0	93,83	55 x 22 132,96
BSPT 5/8-14 h.		1	22,91	20,00	19,50 x 20,40	22,4	80 x 36 x 14,5	164,55	55 x 19 277,45
BSPT 3/4-14 h.		1	26,44	23,50	23,00 x 24,00	21,8	85 x 33 x 16,0	153,11	55 x 22 251,09
BSPT 7/8-14 h.		1	30,20	27,25	26,65 x 28,75	24,0	100 x 36 x 18,0	290,16	65 x 22 362,48
BSPT 1"-11 h.		1	33,25	29,60	29,00 x 30,20	26,0	110 x 38 x 20,0	242,48	65 x 25 289,96

BA  Ref. MO **HSS** **DIN 352** Ref. C5 **HSS** **DIN 223**

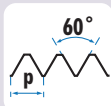

		Uds.	D1 mm		L1 x L2 x 	MO	C5	
						€	Ø x L3 mm	€
BA-0		1,00	3	6,0	5,1	50 x 18 x 4,9	213,39	20 x 5 166,83
BA-1		0,90	3	5,3	4,5	50 x 18 x 4,9	213,39	20 x 5 166,83
BA-2		0,81	3	4,7	4,0	50 x 17 x 4,9	213,39	20 x 5 166,83
BA-3		0,73	3	4,1	3,4	45 x 14 x 3,4	229,31	20 x 5 166,83
BA-4		0,66	3	3,6	3,0	45 x 14 x 3,0	229,31	20 x 5 166,83
BA-5		0,59	3	3,2	2,6	45 x 14 x 3,0	273,99	20 x 5 166,83
BA-6		0,53	3	2,8	2,3	40 x 12 x 2,7	273,99	20 x 5 166,83
BA-7		0,48	3	2,5	2,0	40 x 10 x 2,1	301,23	20 x 5 166,83
BA-8		0,43	3	2,2	1,8	36 x 10 x 2,1	301,23	20 x 5 166,83

JUEGOS DE MACHOS Y TERRAJAS PARA ROSCAR A MANO HSS
UNx8

Rosca AMERICANA

Ref. MO

HSS

DIN
2181TOL
2B

Ref. C5

HSS

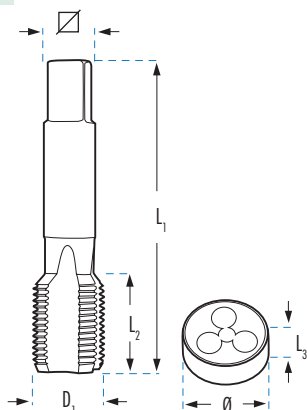
DIN
223TOL
2a

	Uds.	D1 mm		L1 x L2 x mm	MO		C5	
					€	Ø x L3 mm	€	
UN 1"1/8-8h.	2	28,57	25,40	138x65x17,0	402,39	65x25	440,73	
UN 1"1/4-8h.	2	31,75	28,50	146x65x19,5	521,83	65x25	440,73	
UN 1"3/8-8h.	2	34,92	31,75	154x76x21,0	649,01	65x25	438,79	
UN 1"1/2-8h.	2	38,10	35,00	162x76x23,5	742,74	75x30	496,75	
UN 1"5/8-8h.	2	41,27	38,10	170x80x25,0	923,43	75x30	519,95	
UN 1"3/4-8h.	2	44,45	41,25	178x81x27,0	1.150,84	90x36	693,29	
UN 1"7/8-8h.	2	47,62	44,45	186x90x29,0	1.435,74	90x36	741,81	
UN 2"-8h.	2	50,80	47,63	194x90x31,5	1.364,97	90x36	751,06	
UN 2"1/4-8h.	2	57,15	54,00	208x90x36,0				
UN 2"1/2-8h.	2	63,50	60,35	220x100x36,0				
UN 2"3/4-8h.	2	69,85	66,70	234x104x39,0				
UN 3"-8h.	2	76,20	73,05	248x115x49,0				

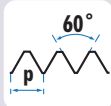
UNEF

Rosca AMERICANA

Ref. MO

HSS

DIN
2181TOL
2B

Ref. C5

HSS

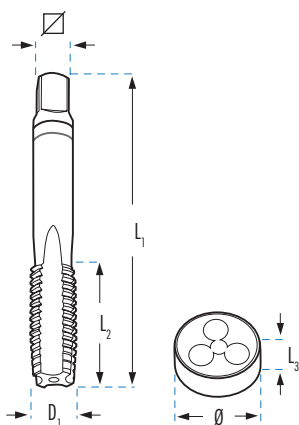
DIN
223TOL
2a

	Uds.	D1 mm		L1 x L2 x mm	MO		C5	
					€	Ø x L3 mm	€	
UNEF 1/4-32h.	2	6,35	5,55	65x28x4,9	108,15	20x7	109,81	
UNEF 5/16-32h.	2	7,94	7,15	70x30x6,0	120,83	25x9	109,81	
UNEF 3/8-32h.	2	9,52	8,70	75x33x7,0	138,28	30x11	170,51	
UNEF 7/16-28h.	2	11,11	10,20	81x38x6,0	176,02	30x11	170,51	
UNEF 1/2-28h.	2	12,70	11,80	86x44x7,0	198,89	38x10	170,51	
UNEF 9/16-24h.	2	14,29	13,20	92x44x8,0	162,59	38x10	170,51	
UNEF 5/8-24h.	2	15,87	14,80	93x47x9,0	167,47	45x14	273,30	
UNEF 3/4-20h.	2	19,05	17,80	108x52x11,0	184,31	45x14	273,30	
UNEF 7/8-20h.	2	22,22	20,95	120x58x13,0	279,71	55x16	325,10	
UNEF 1"-20h.	2	25,40	24,20	130x65x15,0	287,70	55x16	334,01	

JUEGOS DE MACHOS PARA ROSCAR A MANO APLICACIONES ESPECIALES

1100
N/mm²

Ref. MOMD

HSSCo
5%

DIN
352

OX



ESPECIAL MATERIALES DUROS
(≤ 1100 N/mm²=40Hrc)

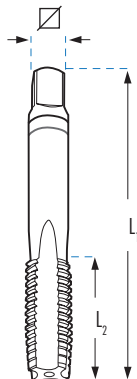

				MOMD	
	Uds.		L ₁ x L ₂ x	€	
M 3 x 0,50	3	2,50	40 x 11 x 2,7	39,47	
M 4 x 0,70	3	3,30	45 x 13 x 3,4	39,47	
M 5 x 0,80	3	4,20	50 x 17 x 4,9	40,75	
M 6 x 1,00	3	5,00	50 x 19 x 4,9	41,95	
M 8 x 1,25	3	6,80	56 x 20 x 4,9	47,70	
M 10 x 1,50	3	8,50	70 x 22 x 5,5	61,22	
M 12 x 1,75	3	10,20	75 x 24 x 7,0	87,66	
M 14 x 2,00	3	12,00	80 x 26 x 9,0	103,76	
M 16 x 2,00	3	14,00	80 x 27 x 9,0	137,87	
M 18 x 2,50	3	15,50	95 x 30 x 11,0	212,04	
M 20 x 2,50	3	17,50	95 x 32 x 12,0	235,41	

1400
N/mm²

Ref. MOC

HSS
PM

TiAlSiN



ESPECIAL MATERIALES MUY DUROS
(≤ 1400 N/mm²=44Hrc)

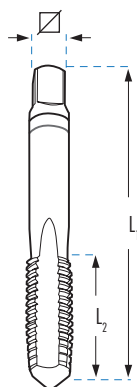

				MOC	
	Uds.		L ₁ x L ₂ x	€	
M 3 x 0,50	3	2,50	40 x 11 x 2,7	85,89	
M 4 x 0,70	3	3,30	45 x 13 x 3,4	92,67	
M 5 x 0,80	3	4,20	50 x 17 x 4,9	93,83	
M 6 x 1,00	3	5,00	50 x 19 x 4,9	93,83	
M 8 x 1,25	3	6,80	56 x 20 x 4,9	105,76	
M 10 x 1,50	3	8,50	70 x 22 x 5,5	130,73	
M 12 x 1,75	3	10,20	75 x 24 x 7,0	158,91	
M 14 x 2,00	3	12,00	80 x 26 x 9,0	190,66	
M 16 x 2,00	3	14,00	80 x 27 x 9,0	233,64	
M 18 x 2,50	3	15,50	95 x 30 x 11,0	323,93	
M 20 x 2,50	3	17,50	95 x 32 x 12,0	356,52	

Al

Ref. MOAL

HSS

BRILLANTE

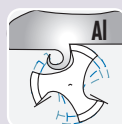

ESPECIAL ALUMINIO

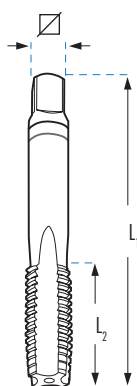

				MOAL	
	Uds.		L ₁ x L ₂ x	€	
M 3 x 0,50	3	2,50	40 x 11 x 2,7	30,74	
M 4 x 0,70	3	3,30	45 x 13 x 3,4	29,84	
M 5 x 0,80	3	4,20	50 x 17 x 4,9	31,62	
M 6 x 1,00	3	5,00	50 x 19 x 4,9	31,62	
M 8 x 1,25	3	6,80	56 x 20 x 4,9	38,81	
M 10 x 1,50	3	8,50	70 x 22 x 5,5	47,39	
M 12 x 1,75	3	10,20	75 x 24 x 7,0	66,72	
M 14 x 2,00	3	12,00	80 x 26 x 9,0	76,67	
M 16 x 2,00	3	14,00	80 x 27 x 9,0	108,83	
M 18 x 2,50	3	15,50	95 x 30 x 11,0	144,24	
M 20 x 2,50	3	17,50	95 x 32 x 12,0	162,61	

JUEGOS DE MACHOS Y TERRAJAS PARA ROSCAR A MANO INOXIDABLE

M

INOX

Ref. MOT

Ref. MOX

DIN
352TOL
6H

TiN



Ref. CST

Ref. CSX

DIN
223TOL
6g

OX



		Uds.	L ₁ x L ₂ x ∇ mm	MOT	CST	MOX	CSX	Ø x L3 mm
				HSS	HSS	HSSCo	HSSCo	
				TiN	TiN	OX	OX	
				€	€	€	€	
M 3 x 0,50		3	40 x 11 x 2,70	44,01	64,71	40,59	35,15	20 x 5
M 4 x 0,70		3	45 x 13 x 3,40	46,24	64,71	40,59	35,15	20 x 5
M 5 x 0,80		3	50 x 16 x 4,90	49,06	64,71	42,26	36,85	20 x 7
M 6 x 1,00		3	50 x 19 x 4,90	49,06	64,71	42,13	37,37	20 x 7
M 8 x 1,00		2	50 x 19 x 4,90	43,13				
M 8 x 1,25		3	56 x 22 x 4,90	56,58	66,34	49,03	40,53	25 x 9
M 10 x 1,00		2	63 x 18 x 5,50	49,76				
M 10 x 1,50		3	70 x 24 x 5,50	75,35	87,10	63,08	51,43	30 x 11
M 12 x 1,50		2	70 x 20 x 7,00	63,36				
M 12 x 1,75		3	75 x 29 x 7,00	87,43	96,57	90,33	54,33	38 x 14
M 14 x 1,50		2	70 x 20 x 9,00	76,08				
M 14 x 2,00		3	80 x 30 x 9,00	105,73	96,57	100,03	54,33	38 x 14
M 16 x 2,00		3	80 x 32 x 9,00	132,78	119,01	137,09	72,94	45 x 18
M 18 x 2,50		3	95 x 40 x 11,00	164,59		187,23		
M 20 x 2,50		3	95 x 40 x 12,00	170,68		207,82		
M 22 x 2,50		3	100 x 40 x 14,50	215,91				
M 24 x 3,00		3	110 x 50 x 14,50	260,17				

M

TERRAJAS HEXAGONALES HSS PARA ROSCAR A MANO

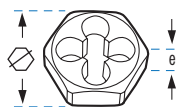

M HSS DIN 382

		C5HM	
			€
M 3 x 0,35	18 x 5		41,87
M 3 x 0,50	19 x 5		41,87
M 3,5 x 0,60	18 x 5		41,87
M 4 x 0,50	18 x 5		41,87
M 4 x 0,70	19 x 5		41,87
M 5 x 0,50	18 x 5		41,87
M 5 x 0,75	18 x 5		41,87
M 5 x 0,80	19 x 7		41,87
M 6 x 0,75	18 x 7		41,87
M 6 x 1,00	19 x 7		41,87
M 7 x 0,75	21 x 9		44,51
M 7 x 1,00	21 x 9		44,51
M 8 x 0,75	21 x 9		44,51
M 8 x 1,00	21 x 9		44,51
M 8 x 1,25	22 x 9		44,51
M 9 x 0,75	21 x 9		52,39
M 9 x 1,00	21 x 9		52,39
M 9 x 1,25	22 x 9		52,39
M 10 x 1,00	27 x 11		52,39
M 10 x 1,25	27 x 11		52,39
M 10 x 1,50	27 x 11		52,39
M 11 x 1,00	27 x 11		87,29
M 11 x 1,50	27 x 11		87,29
M 12 x 1,25	36 x 10		87,29
M 12 x 1,50	36 x 10		87,29
M 12 x 1,75	36 x 10		73,34
M 14 x 1,25	36 x 14		99,19
M 14 x 1,50	36 x 10		99,19
M 14 x 2,00	36 x 10		73,34
M 15 x 1,00	36 x 14		115,05
M 15 x 1,50	41 x 14		115,05
M 16 x 1,00	41 x 14		115,05
M 16 x 1,50	41 x 14		115,05

		C5HM	
			€
M 16 x 2,00	41 x 18		115,05
M 18 x 1,00	41 x 14		115,05
M 18 x 1,50	41 x 14		115,05
M 18 x 2,50	41 x 18		115,05
M 20 x 1,00	41 x 14		115,05
M 20 x 1,50	41 x 14		115,05
M 20 x 2,00	41 x 18		115,05
M 20 x 2,50	41 x 18		115,05
M 22 x 1,00	50 x 16		145,47
M 22 x 1,50	50 x 16		145,47
M 22 x 2,00	50 x 16		145,47
M 22 x 2,50	50 x 16		145,47
M 24 x 1,00	50 x 16		177,17
M 24 x 1,50	50 x 16		177,17
M 24 x 2,00	50 x 16		177,17
M 24 x 3,00	50 x 22		145,47
M 27 x 1,50	60 x 18		196,69
M 27 x 2,00	60 x 18		196,69
M 27 x 3,00	60 x 25		163,90
M 30 x 1,00	60 x 18		196,69
M 30 x 1,50	60 x 18		196,69
M 30 x 2,00	60 x 18		196,69
M 30 x 3,00	60 x 18		196,69
M 30 x 3,50	60 x 25		163,90
M 33 x 1,50	60 x 18		220,23
M 33 x 2,00	60 x 18		220,23
M 33 x 3,50	60 x 25		183,54
M 35 x 1,50	60 x 18		227,04
M 36 x 1,50	60 x 18		227,04
M 36 x 2,00	60 x 18		227,04
M 36 x 3,00	60 x 18		227,04
M 36 x 4,00	60 x 25		189,20

BSP (GAS) HSS DIN 382

		C5HG	
			€
G 1/8 x 28h.	27 x 11		92,20
G 1/4 x 19h.	36 x 10		92,20
G 3/8 x 19h.	41 x 14		115,30
G 1/2 x 14h.	41 x 14		115,30
G 5/8 x 14h.	50 x 16		271,47
G 3/4 x 14h.	50 x 16		271,47
G 7/8 x 14h.	60 x 18		273,88
G 1" x 11h.	60 x 18		273,88
G1.1/4 x 11h.	70 x 20		365,18
G1.1/2 x 11h.	85 x 22		616,07
G 2" x 11h.	100 x 22		927,05

UNC HSS DIN 382

		C5HNC	
			€
UNC 1/4-20h	18 x 7		38,18
UNC 5/16-18h	21 x 9		47,51
UNC 3/8-16h	27 x 11		57,35
UNC 7/16-14h	27 x 11		84,64
UNC 1/2-13h	36 x 14		84,95
UNC 9/16-12h	36 x 14		101,52
UNC 5/8-11h	41 x 18		78,65
UNC 3/4-10h	41 x 18		125,11
UNC 7/8-9h	50 x 22		177,55
UNC 1"-8h	50 x 22		177,55
UNC 1.1/8-7h	60 x 25		234,75
UNC 1.1/4-7h	60 x 25		234,75

UNF HSS DIN 382

		C5HNF	
			€
UNF 1/4-28h.	18 x 7		40,47
UNF 5/16-24h.	21 x 9		50,60
UNF 3/8-24h.	27 x 11		60,88
UNF 7/16-20h.	27 x 11		89,70
UNF 1/2-20h.	36 x 10		91,08
UNF 9/16-18h.	36 x 10		101,52
UNF 5/8-18h.	41 x 14		126,65
UNF 3/4-16h.	41 x 14		132,63
UNF 7/8-14h.	50 x 16		167,75
UNF 1"-12h.	50 x 16		175,84
UNS 1"-14h.	50 x 16		175,84
UNF 1.1/8-12h.	60 x 18		234,75
UNF 1.1/4-12h.	60 x 18		234,75

BSW HSS DIN 382

		C5HW	
			€
BSW 1/8 x 40h.	19 x 5		52,39
BSW 3/16 x 24h.	19 x 7		52,39
BSW 1/4 x 20h.	19 x 7		52,39
BSW 5/16 x 18h.	22 x 9		54,99
BSW 3/8 x 16h.	27 x 11		65,47
BSW 7/16 x 14h.	27 x 11		65,47
BSW 1/2 x 12h.	36 x 14		78,59

		C5HW	
			€
BSW 9/16 x 12h.	36 x 14		78,59
BSW 5/8 x 11h.	41 x 18		116,13
BSW 3/4 x 10h.	41 x 18		116,13
BSW 7/8 x 9h.	50 x 22		170,21
BSW 1" x 8h.	50 x 22		170,21
BSW 1.1/8 x 7h.	60 x 25		293,37

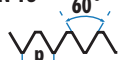
JUEGOS DE MACHOS Y TERRAJAS PARA ROSCAR A MANO, ROSCA A IZQUIERDA
M
MF
DIN 13

Ref. MOI

HSS

(M)

DIN
352

(MF)

DIN
2181
TOL
6H

Ref. CSI

HSS
DIN
223
TOL
6g

Para materiales hasta 38 HRC

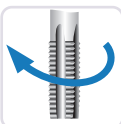

IZQUIERDA

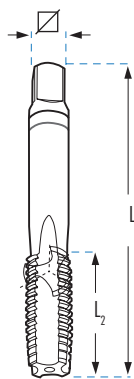
UNC

	Uds.	D1 mm		L1 x L2 x mm	MOI		CSI	
					€	Ø x L3 mm	€	
UNC 1/4-20h.	3	6,35	5,10	50x19x4,9	99,75	20x7	85,37	
UNC 5/16-18h.	3	7,94	6,60	56x22x4,9	113,24	25x9	87,59	
UNC 3/8-16h.	3	9,52	8,00	70x24x5,5	128,83	30x11	121,79	
UNC 1/2-13h.	3	12,70	10,75	75x29x7,0	193,02	38x14	125,19	
UNC 5/8-11h.	3	15,87	13,50	80x32x9,0	314,27	45x18	177,59	
UNC 3/4-10h.	3	19,05	16,50	95x40x11,0	428,21	45x18	177,59	
UNC 1"-8h.	3	25,40	22,25	110x50x14,5	711,81	55x22	238,38	

UNF

	Uds.	D1 mm		L1 x L2 x mm	MOI		CSI	
					€	Ø x L3 mm	€	
UNF 1/4-28h.	2	6,35	5,50	50x14x4,9	66,21	25x9	79,97	
UNF 5/16-24h.	2	7,94	6,90	56x22x4,9	70,88	25x9	89,26	
UNF 3/8-24h.	2	9,52	8,50	63x20x5,5	81,84	38x10	121,79	
UNF 1/2-20h.	2	12,70	11,50	70x22x7,0	111,12	38x10	130,17	
UNF 5/8-18h.	2	15,87	14,50	70x22x9,0	187,05	45x14	177,59	
UNF 3/4-16h.	2	19,05	17,50	80x22x11,0	251,24	45x14	177,59	
UNS 1"-14h.	2	25,40	23,60	90x22x14,5	474,27	55x16	259,02	

BSP
(GAS)

	Uds.	D1 mm		L1 x L2 x mm	MOI		CSI	
					€	Ø x L3 mm	€	
G 1/8-28h.	2	9,73	8,80	63 x 20 x 5,5	74,02	38x10	108,89	
G 1/4-19h.	2	13,16	11,80	70 x 22 x 9,0	104,32	38x10	108,31	
G 3/8-19h.	2	16,66	15,25	70 x 22 x 9,0	130,95	45x14	143,46	
G 1/2-14h.	2	20,95	19,00	80 x 22 x 12,0	183,67	45x14	143,46	
G 5/8-14h.	2	22,91	21,00	80 x 22 x 14,5	235,00	55x16	199,02	
G 3/4-14h.	2	26,44	24,50	90 x 22 x 16,0	286,69	55x16	259,07	
G 1"-11h.	2	33,25	30,75	100 x 25 x 20,0	454,50	65x18	311,39	
G 1.1/4-11h.	2	41,91	39,50	125 x 40 x 24,0	790,40	75x20	431,41	

BSW

	Uds.	D1 mm		L1 x L2 x mm	MOI		CSI	
					€	Ø x L3 mm	€	
W 1/8-40h.	3	3,17	2,55	40x14x2,7	65,67	25x9	68,54	
W 1/4-20h.	3	6,35	5,10	50x20x4,9	73,97	25x9	69,92	
W 5/16-18h.	3	7,94	6,50	56x20x4,9	90,35	25x9	72,92	
W 3/8-16h.	3	9,52	7,90	63x22x5,5	99,27	38x10	105,53	
W 5/8-11h.	3	15,87	13,40	80x27x9,0	223,72	45x18	150,61	
W 3/4-10h.	3	19,05	16,50	95x32x11,0	318,48	45x18	150,83	
W 7/8-9h.	3	22,22	19,25	100x32x14,5	434,95	55x22	221,78	
W 1"-8h.	3	25,40	21,75	110x36x14,5	533,03	55x22	223,80	

	Uds.		L1 x L2 x mm	MOI		CSI	
				€	Ø x L3 mm	€	
M 2x0,40	3	1,60	36x9,0x2,1	81,02	16x5	68,21	
M 3x0,50	3	2,50	40x11,0x2,7	45,48	25x9	62,03	
M 4x0,70	3	3,30	45x13,0x3,4	45,44	25x9	62,35	
M 5x0,80	3	4,20	50x16,0x4,9	48,57	25x9	61,99	
M 6x1,00	3	5,00	50x19x4,9	48,57	25x9	62,03	
M 7x1,00	3	6,00	50x19x4,9	59,18	25x9	65,12	
M 8x1,00	2	7,00	56x18x4,9	54,59	25x9	71,97	
M 8x1,25	3	6,80	56x22x4,9	59,12	25x9	65,81	
M 9x1,25	3	7,80	63x22x5,5	96,86	25x9	76,50	
M 10x1,50	3	8,50	70x24x5,5	72,90	38x10	88,10	
M 12x1,50	2	10,50	70x20x7,0	88,07	38x10	110,42	
M 12x1,75	3	10,20	75x29x7,0	102,57	38x14	95,72	
M 14x1,25	2	12,80	70x20x9,0	126,20	38x10	143,22	
M 14x2,00	3	12,00	80x30x9,0	113,46	38x14	94,77	
M 16x1,50	2	14,50	70x20x9,0	122,12	45x14	137,15	
M 16x2,00	3	14,00	80x32x9,0	162,35	45x18	128,50	
M 18x2,00	2	16,00	80x22x11,0	256,80	45x14	185,60	
M 18x2,50	3	15,50	95x40x11,0	214,26	45x18	128,56	
M 20x2,00	2	18,00	80x22x12,0	272,00	45x14	184,63	
M 20x2,50	3	17,50	95x40x12,0	240,36	45x18	126,55	
M 22x2,00	2	20,00	80x22x14,5	353,48	55x16	237,89	
M 22x2,50	3	19,50	100x40x14,5	320,17	55x22	190,16	
M 24x2,00	2	22,00	90x22x14,5	421,50	55x16	242,40	
M 24x3,00	3	21,00	110x50x14,5	381,88	55x22	190,16	
M 27x2,00	2	25,00	90x22x16,0	584,15	65x18	358,26	
M 27x3,00	3	24,00	110x50x16,0	482,91	65x25	288,44	
M 30x3,00	2	27,00	125x56x18,0	619,28	65x25	406,62	
M 30x3,50	3	26,50	125x50x18,0	621,30	65x25	289,17	
M 33x2,00	2	31,00	100x25x20,0	883,41	65x18	502,28	
M 33x3,50	3	29,50	125x50x20,0	780,16	65x25	294,71	
M 36x3,00	2	33,00	125x33x22,0	1.426,26	65x25	346,56	
M 36x4,00	3	32,00	150x53x22,0	1.004,41	65x25	300,47	
M 39x3,00	2	36,00	125x33x24,0	1.233,12	75x30	542,91	
M 39x4,00	3	35,00	150x53x24,0	1.123,87	75x30	457,02	

Consulte otras medidas disponibles bajo demanda

MACHO Nº3 PARA ROSCAR A MANO, ROSCA METRICA, A IZQUIERDA Y DERECHA

**M
MF**

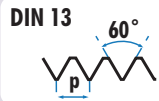

HSS

**DIN
352**

**TOL
6H**

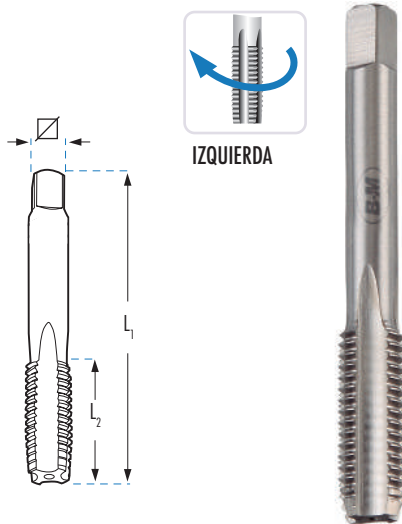

IZQUIERDA



DERECHA

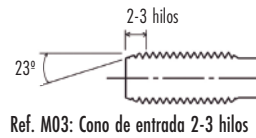

Ref. M03: Cono de entrada 2-3 hilos

**D
MANGO
DELGADO**
**DIN
352**

			M031
		L1 x L2 x D2 x √ mm	€
M 3x0,50	2,50	D 40 x 11 x 3,50 x 2,70	15,16
M 4x0,70	3,30	D 45 x 13 x 4,50 x 3,40	15,15
M 5x0,80	4,20	D 50 x 16 x 6,00 x 4,90	16,19
M 6x1,00	5,00	D 50 x 19 x 6,00 x 4,90	16,19
M 7x1,00	6,00	D 50 x 19 x 6,00 x 4,90	19,73
M 8x1,25	6,75	D 56 x 22 x 6,00 x 4,90	19,71
M 10x1,50	8,50	D 70 x 24 x 7,00 x 5,50	24,30
M 12x1,75	10,20	D 75 x 29 x 9,00 x 7,00	34,19
M 14x2,00	12,00	D 80 x 30 x 11,00 x 9,00	37,82
M 16x2,00	14,00	D 80 x 32 x 12,00 x 9,00	54,12
M 18x2,50	15,50	D 95 x 40 x 14,00 x 11,00	71,42
M 20x2,50	17,50	D 95 x 40 x 16,00 x 12,00	80,12

Consulte otras medidas disponibles bajo demanda

			M03
		L1 x L2 x D2 x √ mm	€
M 3x0,50	2,50	D 40 x 11 x 3,50 x 2,70	7,58
M 4x0,70	3,30	D 45 x 13 x 4,50 x 3,40	7,57
M 5x0,80	4,20	D 50 x 16 x 6,00 x 4,90	8,10
M 6x1,00	5,00	D 50 x 19 x 6,00 x 4,90	8,10
M 7x1,00	6,00	D 50 x 19 x 6,00 x 4,90	9,86
M 8x1,00	7,00	D 56 x 18 x 6,00 x 4,90	13,65
M 8x1,25	6,75	D 56 x 22 x 6,00 x 4,90	9,85
M 9x1,25	7,75	D 63 x 18 x 7,00 x 5,50	16,14
M 10x1,00	9,00	D 63 x 18 x 7,00 x 5,50	14,62
M 10x1,25	8,80	D 70 x 24 x 7,00 x 5,50	14,82
M 10x1,50	8,50	D 70 x 24 x 7,00 x 5,50	12,15
M 12x1,00	11,00	D 70 x 20 x 9,00 x 7,00	25,91
M 12x1,25	10,75	D 70 x 20 x 9,00 x 7,00	25,84
M 12x1,50	10,50	D 70 x 20 x 9,00 x 7,00	22,02
M 12x1,75	10,20	D 75 x 29 x 9,00 x 7,00	17,09
M 14x1,00	13,00	D 70 x 20 x 11,00 x 9,00	40,39
M 14x1,25	12,80	D 70 x 20 x 11,00 x 9,00	31,55
M 14x1,50	12,50	D 70 x 20 x 11,00 x 9,00	24,53
M 14x2,00	12,00	D 80 x 30 x 11,00 x 9,00	18,91
M 16x1,00	15,00	D 70 x 20 x 12,00 x 9,00	53,58
M 16x1,25	14,75	D 70 x 20 x 12,00 x 9,00	56,40
M 16x1,50	14,50	D 70 x 20 x 12,00 x 9,00	30,53
M 16x2,00	14,00	D 80 x 32 x 12,00 x 9,00	27,06
M 18x1,50	16,50	D 80 x 22 x 14,00 x 11,00	40,22
M 18x2,50	15,50	D 95 x 40 x 14,00 x 11,00	35,71
M 20x1,50	18,50	D 80 x 22 x 16,00 x 12,00	50,37
M 20x2,50	17,50	D 95 x 40 x 16,00 x 12,00	40,06
M 22x2,50	19,50	D 100 x 40 x 18,00 x 14,50	53,36
M 24x3,00	21,00	D 110 x 50 x 18,00 x 14,50	63,65
M 27x3,00	24,00	D 110 x 50 x 20,00 x 16,00	80,48
M 30x3,50	26,50	D 125 x 50 x 22,00 x 18,00	103,55

GALGAS PARA LA COMPROBACIÓN DE PASOS DE ROSCAS



	TIPOS DE ROSCA	RANGO DE PASOS		GAM
		Métricos	Ingleses	€
GAM	Pasos rosca métrica	0,25 - 2,5		12,27
GAMW	Pasos rosca métrica /rosca Inglesa	0,25 - 6,0	62h - 4h	22,23

CONJUNTO DE GUIAS PARA COJINETES M3-M12

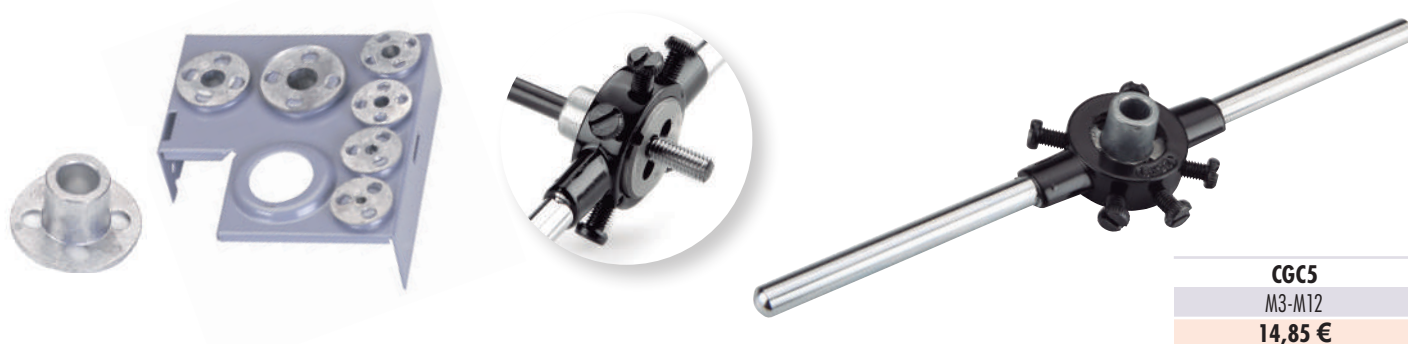

CGC5
M3-M12
14,85 €

ALARGADOR DE MACHOS

DIN
377

DIN 10

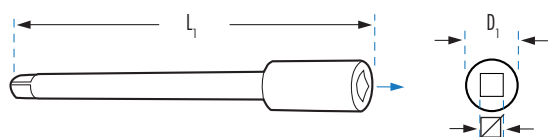

Misma medida de cuadradillo tanto en zona macho como hembra

	∅ x L1 mm	D1 mm	AL €
AL21	2,1 x 60	6,0	8,89
AL24	2,4 x 70	6,0	8,89
AL27	2,7 x 80	7,0	8,89
AL30	3,0 x 90	7,0	8,89
AL34	3,4 x 95	8,0	9,64
AL38	3,8 x 95	9,0	10,06
AL43	4,3 x 105	10,0	11,21
AL49	4,9 x 110	11,0	11,22
AL55	5,5 x 115	12,0	11,29
AL62	6,2 x 120	14,0	13,75
AL70	7,0 x 125	15,0	14,33
AL80	8,0 x 125	17,0	17,89
AL90	9,0 x 135	19,0	18,38

	∅ x L1 mm	D1 mm	AL €
AL100	10,0 x 140	21,0	25,39
AL110	11,0 x 150	23,0	25,74
AL120	12,0 x 160	25,0	27,72
AL130	13,0 x 165	27,0	43,36
AL145	14,5 x 175	29,0	43,97
AL160	16,0 x 185	30,0	46,53
AL180	18,0 x 195	33,0	53,01
AL200	20,0 x 220	36,0	70,71
AL220	22,0 x 220	40,0	103,34
AL240	24,0 x 235	42,0	158,27
AL260	26,0 x 245	45,0	167,12
AL290	29,0 x 260	55,0	192,82
AL320	32,0 x 280	55,0	237,36

Máxima Resistencia
150 kg/mm²

GIRAMACHOS DE ACERO FORJADO

Ref. GAPRO

- Cuerpo de Acero Forjado.
- Soporta esfuerzos hasta 150 kg/mm².
- Máxima resistencia y durabilidad.

- Mayor precisión y firmeza en el amarre.
- Su rosca de precisión conforma un conjunto sólido y robusto.
- Maneral antideslizante, mayor agarre en el taller.



GAPRO

Nº NORMA	Nº 0	Nº 1	Nº 1.1/2	Nº 2	Nº 3	Nº 4	Nº 5
	M1-M8 2,00-5,00	M1-M10 2,00-6,30	M1-M12 2,50-7,00	M1-M12 2,50-8,00	M5-M20 4,00-13,00	M5-M27 4,00-16,00	M9-M32 5,50-20,00
€	22,05	23,30	24,76	31,29	44,28	70,80	149,85

Ref. GA

- Cuerpo de Aleación de Zinc.
- Alta resistencia y durabilidad.
- Alta precisión y firmeza en el amarre.



GA

Nº NORMA	Nº 0	Nº 1	Nº 1.1/2	Nº 2	Nº 3	Nº 4	Nº 5	Nº 7	Nº 8
	M1-M8 1,50-5,00	M1-M10 2,00-7,00	M1-M12 2,00-8,00	M4-M12 2,50-10,00	M5-M20 3,50-14,00	M9-M27 4,00-15,00	M13-M32 5,50-19,00	M22-M52 14,00-34,00	M33-M64 16,00-40,00
€	18,53	19,59	20,81	26,29	37,20	59,50	125,93	248,77	406,43

VOLVEDORES PARA TERRAJAS DE ROSCAR

Ref. VA

DIN
225



5

IMPORTANTE: A la hora de cursar sus pedidos de volvedores, indiquen el espesor del volvedor que corresponda, según detalle de espesores que indicamos en la tarifa de terrajas.

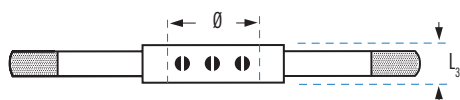

VA

Ø x L3 mm	16x5	20x5	20x7	25x9	30x11	38x10	38x14	45x14	45x18	55x16	55x22	65x18	65x25
€	10,29	11,39	11,39	13,00	15,75	20,59	20,56	25,28	25,46	32,67	34,22	46,81	46,81
Ø x L3 mm	75x20	75x30	90x22	90x36	105x22	105x36	120x22	120x36	130x25	130x36			
€	106,31	111,28	134,66	145,08	200,35	200,35	521,07	521,07	541,71	541,71			

Ref. VA

PULGADAS



3



VA

Ø mm	20,60	25,40	38,10	50,80	63,50	76,20	88,90
PULGADAS	13/16"	1"	1.1/2"	2"	2.1/2"	3"	3.1/2"
€	13,54	16,06	24,04	35,65	56,26	104,04	131,79

NOTA: Los volvedores para terrajas en Ø exteriores en pulgadas, están en desuso.

GIRAMACHOS EN T CON CRIQUE

Ref. TC

TIPO
T

SERIE CORTA



	CAPACIDAD mm mín.-máx.	Para mangos de machos		L ₁ mm	PESO g	CALIDAD	TC
		DIN	ISO				€
TC3B	2,6 - 5,5	M3 - 8	M3 - 6	85	180	1ª Calidad	30,26
TC4B	4,6 - 8,0	M5 - 12	M6 - 12	110	300	1ª Calidad	40,89
TC1B	2,6 - 5,5	M3 - 8	M3 - 6	85	180	2ª Calidad	22,92
TC2B	4,6 - 8,0	M5 - 12	M6 - 12	110	300	2ª Calidad	30,74

Ref. TL

TIPO
T

SERIE LARGA

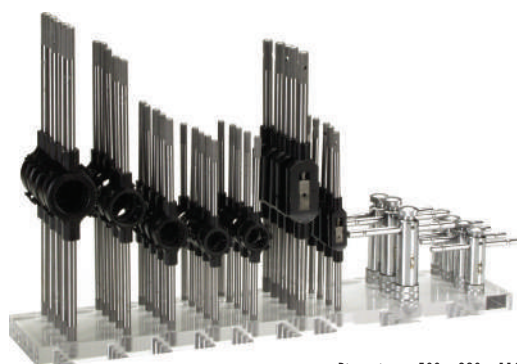

	CAPACIDAD mm mín.-máx.	Para mangos de machos		L ₁ mm	PESO g	CALIDAD	TL
		DIN	ISO				€
TL3	2,6 - 5,5	M3 - 8	M3 - 6	250	250	1ª Calidad	46,03
TL4	4,6 - 8,0	M5 - 12	M6 - 12	300	440	1ª Calidad	54,80
TL1	2,6 - 5,5	M3 - 10	M3 - 6	250	250	2ª Calidad	36,35
TL2	4,6 - 8,0	M5 - 12	M6 - 12	300	440	2ª Calidad	43,31

EXPOSITOR DE METACRILATO

Dimensiones: 500 x 320 x 110 mm

				GV-01
				€
GV-01	Nº 1 1/2 5	Nº 2 5	20 x 5 20 x 7 25 x 9 5 5 5 30 x 11 38 x 14 5 5	TC1 TC2 4 4 797,07

CONJUNTOS DE MACHOS Y COJINETES EN CAJA METÁLICA HSS

**M3
M12**

HSS



Ref. D624

CONTENIDO

					Nº Piezas	1ª Calidad €	2ª Calidad €
D624	M3 - M4 - M5 - M6 - M8 - M10 - M12	Nº 1.1/2	25 x 9	-	30	258,27	234,29

CONJUNTOS DE COJINETES EN CAJA METÁLICA HSS

**M3
M12**

HSS



Ref. D671

CONTENIDO

				Nº Piezas	1ª Calidad €	2ª Calidad €	
D671	M3 - M4 - M5 - M6 - M8 - M10 - M12	20 x 5 30 x 11	20 x 7 38 x 14	25 x 9	12	254,76	215,79
D6711 (Izq)		M3 - M4 - M5 - M6 - M8 - M10 - M12	20 x 5 30 x 11	20 x 7 38 x 14	25 x 9	458,57	388,41

CONJUNTOS DE MACHOS Y COJINETES EN CAJA METÁLICA HSS Y HSSCo
**M3
M12**

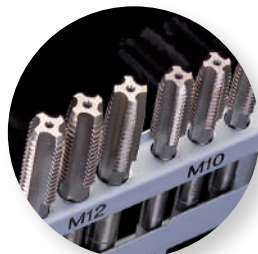
HSS
**HSSCo
5%**

Ref. D621



Ref. D655

CONTENIDO

							Nº Piezas	1ª Calidad €	2ª Calidad €
D621	M3 - M4 - M5 - M6 M8 - M10 - M12	2.5 / 3.3 / 4.2 / 5.0 6.8 / 8.5 / 10.2 mm	Nº 1 Nº 2	20 x 5 20 x 7 25 x 9 30 x 11 38 x 14		TC1	43	517,87	379,58
D652	M3 - M4 - M5 - M6 M8 - M10 - M12	2.5 / 3.3 / 4.2 / 5.0 6.8 / 8.5 / 10.2 mm	Nº 1 Nº 2	20 x 5 20 x 7 25 x 9 30 x 11 38 x 14		-	42	501,29	360,46
D662	M3-M4-M5-M6-M7 M8-M9-M10-M11-M12	-	Nº 1 Nº 2	20 x 5 20 x 7 25 x 9 30 x 11 38 x 14		TC1	48	771,48	678,57
D651	M3 - M4 - M5 - M6 M8 - M10 - M12	-	Nº 1 Nº 2	20 x 5 20 x 7 25 x 9 30 x 11 38 x 14		-	35	395,65	363,99
D655* (HSSCo)	M3 - M4 - M5 - M6 M8 - M10 - M12	2.5 / 3.3 / 4.2 / 5.0 6.8 / 8.5 / 10.2 mm	Nº 1 Nº 2	20 x 5 20 x 7 25 x 9 30 x 11 38 x 14		TC1	43	826,14	726,70
D6211 (Izq)	M3 - M4 - M5 - M6 M8 - M10 - M12	2.5 / 3.3 / 4.2 / 5.0 6.8 / 8.5 / 10.2 mm	Nº 1 Nº 2	20 x 5 20 x 7 25 x 9 30 x 11 38 x 14		TC1	43	932,17	683,24

*

**HSSCo
5%**

CONJUNTOS DE MACHOS Y COJINETES EN CAJA METÁLICA HSS Y HSSCo CON GUÍAS PARA COJINETES

M3
M12



HSS HSSCo
 5%

Machos y Terrajas
Verde







GUÍAS



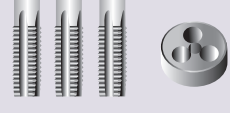

GUÍAS

CONTENIDO

				 + GUÍAS		Nº Piezas	1º Calidad €	2º Calidad €
D656	M3 - M4 - M5 - M6 M8 - M10 - M12	2.5 / 3.3 / 4.2 / 5.0 6.8 / 8.5 / 10.2 mm	Nº 1 Nº 2	20 x 5 20 x 7 25 x 9 30 x 11 38 x 14	TC1	43	578,71	512,29
D657* (HSSCo)	M3 - M4 - M5 - M6 M8 - M10 - M12	2.5 / 3.3 / 4.2 / 5.0 6.8 / 8.5 / 10.2 mm	Nº 1 Nº 2	20 x 5 20 x 7 25 x 9 30 x 11 38 x 14	TC1	43	861,50	760,39

* HSSCo 5%

CONJUNTOS DE MACHOS Y COJINETES EN CAJA METÁLICA HSS Y HSSCo
**M3
M20**
**M5
M20**
HSS
**HSSCo
5%**

Ref. D622



Ref. D623

CONTENIDO

						Nº Piezas	1ª Calidad €	2ª Calidad €
D622	M3 - M4 - M5 - M6 - M8 - M10 - M12 M14 - M16 - M18 - M20	Nº 1 Nº 3	20 x 5 20 x 7 25 x 9 30 x 11 38 x 14 45 x 18		TC1 TC2	54	885,75	695,91
D658	M3 - M4 - M5 - M6 - M8 - M10 - M12 M14 - M16 - M18 - M20	Nº 1 Nº 3	20 x 5 20 x 7 25 x 9 30 x 11 38 x 14 45 x 18		-	52	815,98	629,61
D6221 (Izq)	M3 - M4 - M5 - M6 - M8 - M10 - M12 M14 - M16 - M18 - M20	Nº 1 Nº 3	20 x 5 20 x 7 25 x 9 30 x 11 38 x 14 45 x 18		TC1 TC2	54	1594,35	1.252,64
D659* (HSSCo)	M3 - M4 - M5 - M6 - M8 - M10 - M12 M14 - M16 - M18 - M20	Nº 1 Nº 3	20 x 5 20 x 7 25 x 9 30 x 11 38 x 14 45 x 18		-	52	1839,88	1.618,36
D623	M5 - M6 - M8 - M10 - M12 M14 - M16 - M18 - M20	Nº 1 Nº 3	20 x 7 25 x 9 30 x 11 38 x 14 45 x 18		TC1 TC2	45	928,65	727,04
D663	M5 - M6 - M7 - M8 - M9 - M10 - M12 M14 - M16 - M18 - M20	Nº 1 Nº 3	20 x 7 25 x 9 30 x 11 38 x 14 45 x 18		-	51	1.238,09	1.113,64

*

**HSSCo
5%**

CONJUNTOS DE MACHOS Y COJINETES EN CAJA METÁLICA Y DE MADERA HSS

M1
M10
M5
M12
M3
M24
M5
M30
HSS





Ref. D628

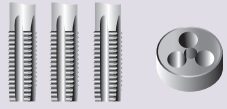

Ref. D626

CONTENIDO

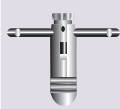
					Nº Piezas	1º Calidad €	2º Calidad €
D626	M1 - M1.2 - M1.4 - M1.7 - M2.0 - M2.3 M2.6 - M3 - M3.5 - M4 - M5 - M6 - M8 - M10	Nº 0 Nº 1	16 x 5 20 x 5 20 x 7 25 x 9 30 x 11	TC1	64	-	1.158,45
D627	M5 - M6 - M7 - M8 - M9 - M10 - M11 - M12	Nº 1 Nº 2	20 x 7 25 x 9 30 x 11 38 x 14	TC1	39	-	865,42
D625	M3 - M4 - M5 - M6 - M8 - M10 - M12 - M14 M16 - M18 - M20 - M22 - M24	Nº 1 Nº 4	20 x 5 20 x 7 25 x 9 30 x 11 38 x 14 45 x 18 55 x 22	-	61	2.044,04	1.508,17
D628	M5 - M6 - M8 - M10 - M12 - M14 - M16 M18 - M20 - M22 - M24 - M27 - M30	Nº 1 Nº 3 Nº 5	20 x 7 25 x 9 30 x 11 38 x 14 45 x 18 55 x 22 65 x 25	-	62	-	2.760,51





CONJUNTOS DE MACHOS Y COJINETES EN CAJA METÁLICA HSS
MF
HSS

Ref. D634



Ref. D636

CONTENIDO

						Nº Piezas	1ª Calidad €	2ª Calidad €
D634	MF 3 x 0.35 - 4 x 0.5 - 5 x 0.5 MF 6 x 0.75 - 8 x 0.75 - 8 x 1.0 MF 10 x 1.0 - 12 x 1.5		Nº 1 Nº 2	20 x 5 25 x 9 30 x 11 38 x 10	TCl	31	-	794,00
D635	MF 6 x 0.75 - 8 x 0.75 - 8 x 1.0 - 10 x 1.0 MF 12 x 1.0 - 12 x 1.5 - 14 x 1.25 - 14 x 1.5 MF 16 x 1.5 - 18 x 1.5 - 20 x 1.5		Nº 1 Nº 3	20 x 7 25 x 9 30 x 11 38 x 10 45 x 14	-	40	1.295,17	1.231,61
D636	MF 6 x 0.75 - 8 x 0.75 - 8 x 1.0 - 10 x 1.0 MF 12 x 1.0 - 12 x 1.5 - 14 x 1.25 - 14 x 1.5 MF 16 x 1.5 - 18 x 1.5 - 20 x 1.5 - 22 x 1.5 MF 24 x 1.5		Nº 1 Nº 4	20 x 7 25 x 9 30 x 11 38 x 10 45 x 14 55 x 16	-	47	1.776,74	1.642,72

CONJUNTOS DE MACHOS Y COJINETES EN CAJA METÁLICA HSS



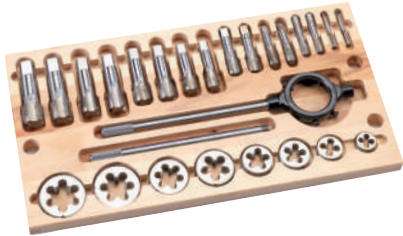

**BSP
(GAS)**

HSS

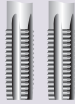

Ref. D638

CONTENIDO

						Nº Piezas	1ª Calidad €	2ª Calidad €
D637	6 1/8 - 1/4 - 3/8 - 1/2 - 3/4 - 1"		Nº 1 Nº 3 Nº 5	30 x 11 38 x 10 45 x 14 55 x 16 65 x 18	-	26	1.438,04	1.161,63
D638	6 1/8 - 1/4 - 3/8 - 1/2 - 5/8 - 3/4 - 7/8 - 1"		Nº 1 Nº 3 Nº 5	30 x 11 38 x 10 45 x 14 55 x 16 65 x 18	-	32	1.951,57	1.703,58
D639	6 1/4 - 3/8 - 1/2 - 3/4 - 1" - 1".1/4 - 1".1/2		Nº 2 Nº 4 Nº 7	38 x 10 45 x 14 55 x 16 65 x 18 75 x 20 90 x 22	-	30	3.600,32	3.037,02



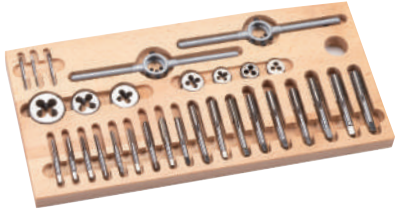

BSW

HSS

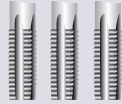

Ref. D640





CONTENIDO

						Nº Piezas	1ª Calidad €	2ª Calidad €
D640	BSW 1/8 - 3/16 - 1/4 - 5/16 - 3/8 - 7/16 - 1/2		Nº 1 Nº 2	20 x 5 20 x 7 25 x 9 30 x 11 38 x 14	TCl	36	802,23	685,78
D641	BSW 1/4 - 5/16 - 3/8 - 7/16 - 1/2		Nº 1 Nº 2	20 x 7 25 x 9 30 x 11 38 x 14	TCl	27	661,33	557,02
D642	BSW 1/4 - 5/16 - 3/8 - 7/16 - 1/2 - 5/8 - 3/4		Nº 1 Nº 3	20 x 7 25 x 9 30 x 11 38 x 14 45 x 18	-	35	1.183,54	1.079,93
D643	BSW 1/4 - 5/16 - 3/8 - 7/16 1/2 - 5/8 - 3/4 - 7/8 - 1"		Nº 1 Nº 4	20 x 7 25 x 9 30 x 11 38 x 14 45 x 18 55 x 22	-	44	1.673,80	1.469,54
D646	BSW 1/4 - 5/16 - 3/8 - 7/16 1/2 - 5/8 - 3/4 - 7/8 - 1" - 1".1/8 1".1/4 - 1".3/8 - 1".1/2		Nº 1 Nº 3 Nº 5	20 x 7 25 x 9 30 x 11 38 x 14 45 x 18 55 x 22 65 x 25	-	62	-	4.465,59

CONJUNTOS DE MACHOS Y COJINETES EN CAJA METÁLICA HSS
BSF
HSS

Ref. D648



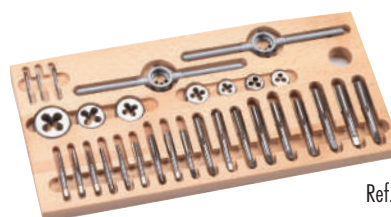

CONTENIDO

					Nº Piezas	1ª Calidad €	2ª Calidad €
D664	BSF 1/4 - 5/16 - 3/8 - 7/16 - 1/2	Nº 1 Nº 2	20 x 7 25 x 9 30 x 11 38 x 10	TCl	22	739,56	650,51
D648	BSF 1/4 - 5/16 - 3/8 - 7/16 - 1/2 - 5/8 - 3/4	Nº 1 Nº 3	20 x 7 25 x 9 30 x 11 38 x 10 45 x 14	-	28	1.148,09	1.079,93
D665	BSF 1/4 - 5/16 - 3/8 - 7/16 1/2 - 5/8 - 3/4 - 7/8 - 1"	Nº 1 Nº 4	20 x 7 25 x 9 30 x 11 38 x 10 45 x 14 55 x 16	-	35	1.948,12	1.713,55

**BSW
BSF**
HSS

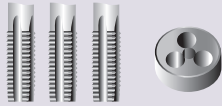
Ref. D666





CONTENIDO

					Nº Piezas	1ª Calidad €	2ª Calidad €
D666	BSW 1/4 - 5/16 - 3/8 - 7/16 - 1/2 - 5/8 - 3/4 BSF 1/4 - 5/16 - 3/8 - 7/16 - 1/2 - 5/8 - 3/4	Nº 1 Nº 3	20 x 7 25 x 9 30 x 11 38 x 14 45 x 18	-	63	2.200,66	1.935,68

CONJUNTOS DE MACHOS Y COJINETES EN CAJA METÁLICA HSS





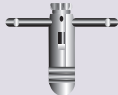

CONTENIDO

						Nº Piezas	1ª Calidad €	2ª Calidad €
D660	NPT 1/8 - 1/4 - 3/8 - 1/2 - 3/4 - 1"		Nº1 Nº3 Nº5	30 x 11 38 x 14 45 x 18 55 x 22 65 x 25	-	20	2.080,19	1.973,16
D661	NPT 1/8 - 1/4 - 3/8 - 1/2 - 3/4 1" - 1.1/4 - 1.1/2 - 2"		Nº 2 Nº 4 Nº 7	30 x 11 38 x 14 45 x 18 55 x 22 65 x 25 75 x 30 90 x 36 105 X 36	-	29	6.227,02	5.850,26

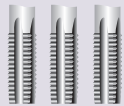

CONTENIDO

						Nº Piezas	1ª Calidad €	2ª Calidad €
D650	UNC 1/4 - 5/16 - 3/8 - 7/16 - 1/2		Nº 1 Nº 2	20 x 7 25 x 9 30 x 11 38 x 14	TCT	27	806,09	723,50
D667	UNC 1/4 - 5/16 - 3/8 - 7/16 - 1/2 - 5/8 - 3/4		Nº 1 Nº 2	20 x 7 25 x 9 30 x 11 38 x 14 45 x 18	-	35	1.298,75	1.142,36
D654	UNC 1/4 - 5/16 - 3/8 - 7/16 1/2 - 5/8 - 3/4 - 7/8 - 1"		Nº 1 Nº 4	20 x 7 25 x 9 30 x 11 38 x 14 45 x 18 55 x 22	-	44	2.095,65	1.961,26
D668	UNC 1/4 - 5/16 - 3/8 - 7/16 - 1/2 - 5/8 - 3/4 7/8 - 1" - 1.1/8 - 1.1/4 - 1.3/8 - 1.1/2"		Nº 1 Nº 3 Nº 6	20 x 7 25 x 9 30 x 11 38 x 14 45 x 18 55 x 22 65 x 25	-	62	4.906,35	4.315,59

CONJUNTOS DE MACHOS Y COJINETES EN CAJA METÁLICA HSS
UNF
HSS

Ref. D644

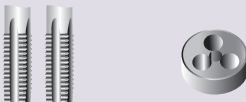
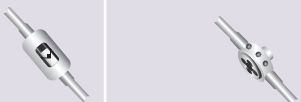
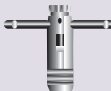

CONTENIDO

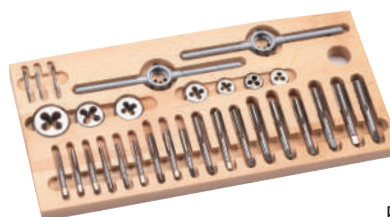
				Nº Piezas	1ª Calidad €	2ª Calidad €	
D644	UNF 1/4 - 5/16 - 3/8 - 7/16 - 1/2	Nº 1 Nº 2	20 x 7 25 x 9 30 x 11 38 x 10	TCT	22	631,65	547,58
D669	UNF 1/4-5/16 -3/8 -7/16 -1/2 -5/8 -3/4	Nº 1 Nº 3	20 x 7 25 x 9 30 x 11 38 x 10 45 x 14	-	28	1.190,50	1.047,16
D645	UNF 1/4 - 5/16 - 3/8 - 7/16 - 1/2 - 5/8 3/4 - 7/8 - 1"	Nº 1 Nº 4	20 x 7 25 x 9 30 x 11 38 x 10 45 x 14 55 x 16	-	34	1.459,80	1.323,60

**UNC
UNF**
HSS

Ref. D670

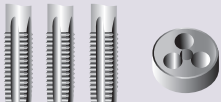
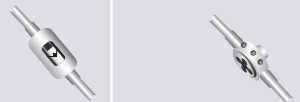
CONTENIDO

				Nº Piezas	1ª Calidad €	2ª Calidad €	
D670	UNC 1/4 - 5/16 - 3/8 - 7/16 - 1/2 - 5/8 - 3/4 UNF 1/4 - 5/16 - 3/8 - 7/16 - 1/2 - 5/8 - 3/4	Nº 1 Nº 3	20 x 7 25 x 9 30 x 11 38 x 14 45 x 18	-	35	2.200,66	1.935,68

JUEGOS DE MACHOS DE MANO HSS Y TiN EN ESTUCHES METÁLICOS



Ref. JMBO









Ref. JMB2

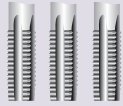

Ref. JMBT2

CONTENIDO

					HSS €		TiN* €
JMB2	M3 - M4 - M5 - M6 M8 - M10 - M12	-	-	-	204,49	JMBT2	406,02
JMBO	M3 - M4 - M5 - M6 M8 - M10 - M12	2.5 / 3.3 / 4.2 / 5.0 6.8 / 8.5 / 10.2 mm	-	-	233,25	JMBT0	455,63
JMB1	M3 - M4 - M5 - M6 M8 - M10 - M12	2.5 / 3.3 / 4.2 / 5.0 6.8 / 8.5 / 10.2 mm	Nº 1.1/2	-	251,04	JMBT1	390,43
JMB5	M3 - M4 - M5 - M6 M8 - M10 - M12	2.5 / 3.3 / 4.2 / 5.0 6.8 / 8.5 / 10.2 mm	Nº 1.1/2	TCT	266,64	JMBT5	409,11
JMBI2 (Izq)	 M3 - M4 - M5 - M6 M8 - M10 - M12	-	-	-	368,07	JMBIT2	730,83
JMBI0 (Izq)	 M3 - M4 - M5 - M6 M8 - M10 - M12	2.5 / 3.3 / 4.2 / 5.0 6.8 / 8.5 / 10.2 mm	-	-	419,86	JMBIT0	820,14
JMBI1 (Izq)	 M3 - M4 - M5 - M6 M8 - M10 - M12	2.5 / 3.3 / 4.2 / 5.0 6.8 / 8.5 / 10.2 mm	Nº 1.1/2	-	451,88	JMBIT1	702,78

MACHOS TERCEROS DE MANO HSS Y TiN EN ESTUCHES METÁLICOS









Ref. JMB3



Ref. JMB4

CONTENIDO

3º					HSS €		TiN* €
JMB3	M3 - M4 - M5 - M6 M8 - M10 - M12	-	-	-	93,87	JMBT3	117,55
JMB4	M3 - M4 - M5 - M6 M8 - M10 - M12	2.5 / 3.3 / 4.2 / 5.0 6.8 / 8.5 / 10.2 mm	-	-	116,83	JMBT4	155,29
JMB7	M3 - M4 - M5 - M6 M8 - M10 - M12	2.5 / 3.3 / 4.2 / 5.0 6.8 / 8.5 / 10.2 mm	Nº 1.1/2	-	133,69	JMBT7	215,41
JMB6	M3 - M4 - M5 - M6 M8 - M10 - M12	2.5 / 3.3 / 4.2 / 5.0 6.8 / 8.5 / 10.2 mm	Nº 1.1/2	TCT	144,77	JMBT6	229,60
JMBI3 (Izq)	 M3 - M4 - M5 - M6 M8 - M10 - M12	-	-	-	168,97	JMBIT3	211,60
JMBI4 (Izq)	 M3 - M4 - M5 - M6 M8 - M10 - M12	2.5 / 3.3 / 4.2 / 5.0 6.8 / 8.5 / 10.2 mm	-	-	210,30	JMBIT4	279,53



MACHOS DE MANO HSSCo EN ESTUCHES METÁLICOS
HSSCo
5%

Ref. JMBX0

CONTENIDO

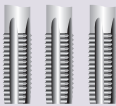
INOX	 MOX	 HSSCo			€
JMBX0	M3 - M4 - M5 - M6 M8 - M10 - M12	2.5 / 3.3 / 4.2 / 5.0 6.8 / 8.5 / 10.2 mm	-	-	322,33
JMBX1	M3 - M4 - M5 - M6 M8 - M10 - M12	2.5 / 3.3 / 4.2 / 5.0 6.8 / 8.5 / 10.2 mm	Nº 1.1/2	-	339,23
JMBX2	M3 - M4 - M5 - M6 M8 - M10 - M12	-	-	-	304,80

CONTENIDO

 1100 N/mm ²	 MOMD	 HSSCo			€
JMBMD0	M3 - M4 - M5 - M6 M8 - M10 - M12	2.5 / 3.3 / 4.2 / 5.0 6.8 / 8.5 / 10.2 mm	-	-	336,62
JMBMD1	M3 - M4 - M5 - M6 M8 - M10 - M12	2.5 / 3.3 / 4.2 / 5.0 6.8 / 8.5 / 10.2 mm	Nº 1.1/2	-	354,13
JMBMD2	M3 - M4 - M5 - M6 M8 - M10 - M12	-	-	-	320,88

ESTUCHES DE COJINETES EN CAJAS METÁLICAS HSS

Ref. C5B3



CONTENIDO

		HSS €
C5B3	M3 - M4 - M5 - M6 - M8 - M10 - M12	244,31
C5B3I (Izda.)	M3 - M4 - M5 - M6 - M8 - M10 - M12	439,75



EXTRACTOR DE MACHOS ROTOS PARA MACHOS DE CANALES RECTOS - NO HELICOIDALES



EXTRACTORES SUELTOS

Ø MACHO A EXTRAER		MACHOS 4 CANALES	MACHOS 3 CANALES	€/ Ud.
BSW	M			EXTRACTOR COMPLETO
--	M3		W10043	46,59
1/8	M3,2		W10053	46,59
--	M3,5		W10063	46,59
5/32	M4		W10083	46,59
3/16	M5		W10103	46,59
--	M5,5	W10124	W10123	46,59
1/4	M6		W10253	47,96
5/16	M8	W10314	W10313	50,25
--	M9	W10374	W10373	49,78
3/8	M10	W10404	W10373	49,78
7/16	M11	W10434	W10433	52,55
1/2	M12	W10504	W10503	56,19
9/16	M14	W10564	W10563	77,65
5/8	M16	W10624	W10623	84,51
--	M18	W10684	W10753	104,71
3/4	M20	W10754	W10753	104,71
7/8	M22	W10874	W10873	114,58
1"	M25	W11004	W11003	127,77

VARILLA REPUESTO

MACHOS 4 CANALES	MACHOS 3 CANALES	€/ Ud.
		VARILLA EXTRA
	W12043	2,48
	W12053	2,48
	W12063	2,48
	W12083	2,48
	W12103	3,70
	W12123	3,70
	W12253	4,51
W12314	W12313	5,09
W12374		5,09
W12404	W12373	5,25
W12434	W12433	5,34
W12504	W12503	6,72
W12564	W12563	7,49
W12624	W12623	9,58
W12684		9,58
W12754	W12753	10,14
W12874	W12873	13,13
W13004	W13003	21,86

3 SIMPLES PASOS PARA EXTRAER MACHOS DE ROSCAR ROTOS DE CANALES RECTOS

Sacar toda la viruta del macho roto. Introducir las varillas del extractor en los canales del macho roto con firmeza hasta el fondo.

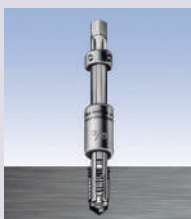

Empujar el soporte hacia abajo, hasta tocar el macho roto. Deslice el casquillo hacia abajo, hasta tocar la zona de trabajo.

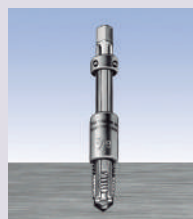

Aplicar al cuadradillo del extractor un gira-machos. Gire a izquierdas unas cuantas veces hasta soltarlo y entonces saque el macho roto.



JUEGOS DE EXTRACTORES PARA MACHOS ROTOS (CANALES RECTOS)







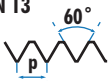
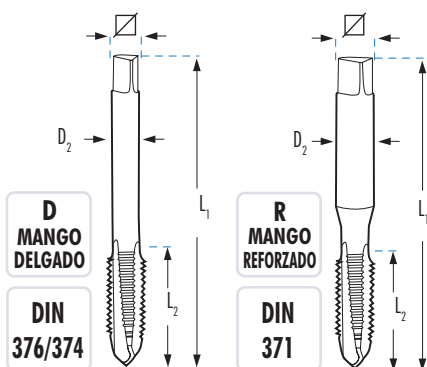

Nº CANALES	MEDIDAS INCLUIDAS PARA MACHOS DE MÁQUINA Y DE MANO: 3 y 4 CANALES	
W180013	3	M5- M6- M8- M10- M11- M12
W180014	4	3/16 - 1/4 - 5/16 - 3/8 - 7/16 - 1/2
W180023	3	M6- M8 -M10- M11- M12- M16
W180024	4	1/4 - 5/16 - 3/8 - 7/16 - 1/2 - 5/8
W180153	3	M3- M3,2- M3,5- M4-M5- M5,50- M6- M8
W180154	4	M9- M10- M12- M16- M18- M22- M25

322,98

363,37

1.016,43

MACHOS PARA ROSCAR A MÁQUINA HSSCo
M
MF
DIN 13

HSSCo
5%
TOL
6H
Vc
12 m/min

		L1 x L2 x D2 x ∇ mm	M1D	M2D	M3D	M4D	M1R	M2R	M3R	M4R
			FORMA C €	FORMA B €	 15° €	 35° €	FORMA C €	FORMA B €	 15° €	 35° €
M 1x0,25	0,75	R 40 x 5,5 x 2,5 x 2,1					45,51			
M 1,1x0,25	0,85	R 40 x 6 x 2,5 x 2,1					44,27			
M 1,2x0,25	0,95	R 40 x 6 x 2,5 x 2,1					40,44			
M 1,4x0,30	1,10	R 40 x 7 x 2,5 x 2,1					40,44			
M 1,6x0,35	1,25	R 40 x 8 x 2,5 x 2,1					39,71			
M 1,7x0,35	1,35	R 40 x 8 x 2,5 x 2,1					38,24			
M 1,8x0,35	1,45	R 40 x 8 x 2,5 x 2,1					37,30			
M 2x0,40	1,60	R 40 x 8 x 2,8 x 2,1					17,96	19,90	22,25	22,67
M 2,2x0,45	1,75	R 40 x 9 x 2,8 x 2,1					19,41			
M 2,3x0,40	1,90	R 40 x 9 x 2,8 x 2,1					17,88			
M 2,5x0,45	2,05	R 50 x 9 x 2,8 x 2,1					17,96	19,90	31,28	22,67
M 2,6x0,45	2,10	R 50 x 9 x 2,8 x 2,1					17,99	20,25		37,68
M 3x0,50	2,50	R 56 x 11 x 3,5 x 2,7 D 56 x 11 x 2,2 x 1,8	11,90	12,88	17,93	15,46	11,90*	12,09	17,58	15,84
M 3x0,60	2,40	R 56 x 11 x 3,5 x 2,7					21,15	23,08		30,48
M 3,5x0,60	2,90	R 56 x 12 x 4,0 x 3,0 D 56 x 12 x 2,5 x 2,1					17,29	18,00	23,25	21,82
M 3,5x0,75	2,75	R 56 x 12 x 4,0 x 3,0					22,86			
M 4x0,50	3,50	R 63 x 13 x 4,5 x 3,4 D 63 x 13 x 2,8 x 2,1	26,05	28,69		30,33	24,90	27,70		32,07
M 4x0,70	3,30	R 63 x 13 x 4,5 x 3,4 D 63 x 13 x 2,8 x 2,1	12,11	13,02	19,23	15,31	13,53*	12,77	17,35	15,86
M 4x0,75	3,25	R 63 x 13 x 4,5 x 3,4					18,93	20,21		
M 4x0,80	3,20	R 63 x 13 x 4,5 x 3,4					100,49			
M 4,5x0,50	4,00	R 70 x 14 x 6,0 x 4,9						32,22		
M 4,5x0,75	3,75	R 70 x 14 x 6,0 x 4,9					23,36	25,73		
M 5x0,50	4,50	R 70 x 14 x 6,0 x 4,9 D 70 x 11 x 3,5 x 2,7	26,83	29,47		30,67	25,64	28,46		34,21
M 5x0,75	4,50	R 74 x 14 x 6,0 x 4,9 D 70 x 16 x 3,5 x 2,7					23,00	26,97		33,99
M 5x0,80	4,20	R 70 x 16 x 6,0 x 4,9 D 70 x 16 x 3,5 x 2,7	12,11	13,09	18,43	14,70	12,12*	12,79	16,64	15,20
M 5x0,90	4,10	R 70 x 15 x 6,0 x 4,9 D 70 x 16 x 3,5 x 2,7					20,00	25,77		
M 5x1,00	4,00	R 72 x 17 x 6,0 x 4,9					53,57			
M 5,5x0,90	4,60	R 80 x 17 x 6,0 x 4,9					53,57			
M 6x0,50	5,50	R 80 x 17 x 6,0 x 4,9 D 80 x 13 x 4,5 x 3,4	31,76	38,94		49,14	33,57			
M 6x0,75	5,25	R 80 x 13 x 6,0 x 4,9 D 80 x 13 x 4,5 x 3,4	20,93	24,23		28,30	21,75	25,34		30,43
M 6x1,00	5,00	R 80 x 19 x 6,0 x 4,9 D 80 x 19 x 4,5 x 3,4	13,81	14,34	19,28	16,12	13,79*	14,03	18,26	16,67

* Consulte el precio de machos y terrajas a izquierdas disponibles en Pag.215





MACHOS PARA ROSCAR A MÁQUINA HSSCo

M MF  **HSSCo 5%** **TOL 6H** **D MANGO DELGADO** **DIN 376/374**  **R MANGO REFORZADO** **DIN 371**

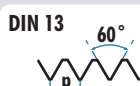
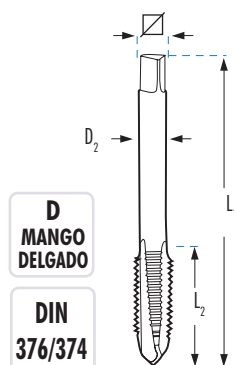
M	Ø	R	L1 x L2 x D2 x mm	M1D	M2D	M3D	M4D	M1R	M2R	M3R	M4R
				FORMA C	FORMA B	15°	35°	FORMA C	FORMA B	15°	35°
				€	€	€	€	€	€	€	€
M 6x1,25	4,75	R	80 x 17 x 6,0 x 4,9					52,66			
M 7x0,75	6,25	D	80 x 13 x 5,5 x 4,3	26,94	29,88		36,91				
M 7x1,00	6,00	R	80 x 19 x 7,0 x 5,5	18,57	21,47	23,19	22,32	17,88 *	20,87	23,60	23,36
		D	80 x 19 x 5,5 x 4,3								
M 8x0,50	7,50	D	80 x 13 x 6 x 4,9	36,24							
M 8x0,75	7,25	D	80 x 13 x 6 x 4,9	26,25	32,19		39,92				
M 8x1,00	7,00	D	90 x 20 x 6 x 4,9	21,47	24,64	29,53	27,30				
M 8x1,25	6,80	R	90 x 22 x 8 x 6,2	15,49	16,18	21,95	18,82	15,58 *	15,59	21,02	19,05
		D	90 x 22 x 6 x 4,9								
M 8x1,50	6,50	D	90 x 20 x 6 x 4,9	106,20							
M 9x1,00	8,00	D	90 x 20 x 7 x 5,5	32,47	34,71		36,89				
M 9x1,25	7,80	R	90 x 22 x 9 x 7,0	26,09	27,42	33,20	32,46	25,84	26,18	33,47	33,39
		D	90 x 22 x 7 x 5,5								
M 10x0,50	9,50	D	90 x 20 x 7 x 5,5	105,22							
M 10x0,75	9,25	D	90 x 16 x 7 x 5,5	41,62	41,71		50,79				
M 10x1,00	9,00	D	90 x 16 x 7 x 5,5	23,77	27,38	34,86	33,21				
M 10x1,25	8,80	D	100 x 22 x 7 x 5,5	27,22	32,74	38,00	36,19				
M 10x1,50	8,50	R	100 x 24 x 10 x 8,0	17,50	19,57	26,09	22,55	17,66 *	19,20	24,14	22,55
		D	100 x 24 x 7 x 5,5								
M 11x1,00	10,00	D	90 x 20 x 8 x 6,2	42,61	44,01	111,26	101,24				
M 11x1,25	9,75	D	100 x 22 x 8 x 6,2	40,77	45,30	111,26	90,37				
M 11x1,50	9,50	D	100 x 24 x 8 x 6,2	33,05	38,00	81,12	73,78				
M 12x0,75	11,25	D	100 x 22 x 9 x 7,0	62,43							
M 12x1,00	11,00	D	100 x 22 x 9 x 7,0	32,33	37,00	43,01	42,55				
M 12x1,25	10,75	D	100 x 22 x 9 x 7,0	32,73	36,35	41,18	40,73				
M 12x1,50	10,50	D	100 x 22 x 9 x 7,0	29,25*	32,42	39,60	39,18				
M 12x1,75	10,20	D	110 x 28 x 9 x 7,0	21,08*	24,44	33,37	28,76				
M 13x0,75	12,25	D	100 x 22 x 11 x 9,0	108,97							
M 13x1,00	12,00	D	100 x 22 x 11 x 9,0	57,71	65,34						
M 13x1,25	11,75	D	100 x 22 x 11 x 9,0	57,71	65,34						
M 13x1,50	11,50	D	100 x 22 x 11 x 9,0	57,71	65,34						
M 13x1,75	11,25	D	100 x 28 x 11 x 9,0	57,30	65,34						
M 14x0,75	13,25	D	100 x 22 x 11 x 9,0	108,97							
M 14x1,00	13,00	D	100 x 22 x 11 x 9,0	52,04	57,25	66,31	65,75				
M 14x1,25	12,80	D	100 x 22 x 11 x 9,0	44,29	48,34	60,82	57,94				
M 14x1,50	12,50	D	100 x 22 x 11 x 9,0	34,84*	38,39	47,96	45,69				
M 14x2,00	12,00	D	110 x 30 x 11 x 9,0	34,61*	38,45	44,56	44,56				
M 15x1,00	14,00	D	100 x 22 x 12 x 9,0	66,18	70,07		89,22				
M 15x1,25	13,75	D	100 x 22 x 12 x 9,0	70,89	76,77						
M 15x1,50	13,50	D	100 x 22 x 12 x 9,0	56,66	64,62	165,08	133,91				
M 15x2,00	13,00	D	110 x 30 x 12 x 9,0	69,35	76,32						
M 16x1,00	15,00	D	100 x 22 x 12 x 9,0	62,38	66,18	92,84	90,14				
M 16x1,25	14,75	D	100 x 22 x 12 x 9,0	66,75	73,37	103,25	99,98				
M 16x1,50	14,50	D	100 x 22 x 12 x 9,0	41,19*	48,00	59,77	56,94				
M 16x2,00	14,00	D	110 x 32 x 12 x 9,0	40,73*	44,98	53,83	53,83				
M 17x1,00	16,00	D	100 x 22 x 12 x 9,0	124,11							
M 17x1,25	15,75	D	100 x 22 x 12 x 9,0	124,11							
M 17x1,50	15,50	D	100 x 22 x 12 x 9,0	124,11							
M 18x1,00	17,00	D	110 x 25 x 14 x 11,0	69,86	76,78		110,30				
M 18x1,25	16,75	D	110 x 25 x 14 x 11,0	86,58							
M 18x1,50	16,50	D	110 x 25 x 14 x 11,0	54,54*	60,02	73,45	71,46				
M 18x2,00	16,00	D	125 x 30 x 14 x 11,0	76,97	85,29	145,34	129,72				

* Consulte el precio de machos y terrajas a izquierdas disponibles en Pag.215

MACHOS PARA ROSCAR A MÁQUINA HSSCo
**M
MF**

**HSSCo
5%**
**TOL
6H**
**D
MANGO
DELGADO**
**DIN
376/374**
**Vc
12 m/min**

			L1 x L2 x D2 x mm	M1D	M2D	M3D	M4D
				FORMA C €	FORMA B €	 15° €	 35° €
M 18x2,50	15,50	D	125 x 34 x 14 x 11,0	58,60*	64,07	72,48	69,80
M 19x1,00	18,00	D	110 x 22 x 14 x 11,0	163,07			
M 19x1,25	17,75	D	110 x 25 x 14 x 11,0	167,70			
M 19x1,50	17,50	D	110 x 25 x 14 x 11,0	160,06			
M 20x1,00	19,00	D	125 x 25 x 16 x 12,0	92,22	102,41		117,81
M 20x1,25	18,75	D	125 x 25 x 16 x 12,0	163,07			
M 20x1,50	18,50	D	125 x 25 x 16 x 12,0	61,77*	67,88	82,55	81,64
M 20x2,00	18,00	D	140 x 32 x 16 x 12,0	80,96	89,01		105,09
M 20x2,50	17,50	D	140 x 34 x 16 x 12,0	62,38*	69,17	77,35	77,36
M 21x1,00	20,00	D	125 x 25 x 16 x 12,0	236,76			
M 21x1,25	19,75	D	125 x 25 x 16 x 12,0	236,76			
M 21x1,50	19,50	D	125 x 25 x 16 x 12,0	226,11			
M 22x1,00	21,00	D	125 x 25 x 18 x 14,5	103,38	109,73		151,82
M 22x1,25	20,75	D	125 x 25 x 18 x 14,5	163,07			
M 22x1,50	20,50	D	125 x 25 x 18 x 14,5	74,35	81,78	90,55	85,20
M 22x2,00	20,00	D	140 x 32 x 18 x 14,5	103,38	113,70		151,82
M 22x2,50	19,50	D	140 x 34 x 18 x 14,5	75,48*	83,02	91,76	90,80
M 23x1,00	22,00	D	125 x 25 x 18 x 14,5	230,18			
M 23x1,50	21,50	D	125 x 25 x 18 x 14,5	230,18			
M 24x1,00	23,00	D	140 x 25 x 18 x 14,5	112,65	136,66		160,41
M 24x1,25	22,75	D	140 x 25 x 18 x 14,5	236,76			
M 24x1,50	22,50	D	140 x 28 x 18 x 14,5	91,44	100,54	121,03	115,29
M 24x2,00	22,00	D	140 x 28 x 18 x 14,5	116,67*	127,11		137,16
M 24x3,00	21,00	D	160 x 38 x 18 x 14,5	90,36*	98,90	110,59	110,37
M 25x1,00	24,00	D	140 x 28 x 18 x 14,5	218,39			
M 25x1,25	23,75	D	140 x 28 x 18 x 14,5	345,09			
M 25x1,50	23,50	D	140 x 28 x 18 x 14,5	142,28	150,58		
M 25x2,00	23,00	D	140 x 28 x 18 x 14,5	306,26	336,90		
M 26x1,00	25,00	D	140 x 28 x 18 x 14,5	169,55			
M 26x1,50	24,50	D	140 x 28 x 18 x 14,5	123,31	129,26	226,74	199,38
M 26x2,00	24,00	D	140 x 28 x 18 x 14,5	238,83	262,72		288,56
M 27x1,00	26,00	D	140 x 28 x 20 x 16,0	151,86	196,08		
M 27x1,50	25,50	D	140 x 28 x 20 x 16,0	134,64	142,63	329,52	297,12
M 27x2,00	25,00	D	140 x 28 x 20 x 16,0	166,54*	176,22		

* Consulte el precio de machos y terrajas a izquierdas disponibles en Pag.215

MACHOS PARA ROSCAR A MÁQUINA HSSCo

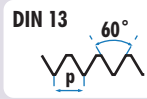
**M
MF**







**HSSCo
5%**

**TOL
6H**

**D
MANGO
DELGADO**

**DIN
376/374**







			L1 x L2 x D2 x ∇ mm	M1D	M2D	M3D	M4D
				FORMA C	FORMA B	 15°	 35°
				€	€	€	€
M 27x3,00			D 160 x 36 x 20 x 16	112,80*	123,70	136,06	135,80
M 28x1,00			D 140 x 28 x 20 x 16	306,26			
M 28x1,50			D 140 x 28 x 20 x 16	134,64	147,82	171,60	154,93
M 28x2,00			D 140 x 28 x 20 x 16	164,26	185,51	202,23	198,87
M 30x1,00			D 150 x 28 x 22 x 18	172,21	199,13		232,17
M 30x1,50			D 150 x 28 x 22 x 18	140,34	154,42	186,09	177,24
M 30x2,00			D 150 x 28 x 22 x 18	173,71*	184,37		255,11
M 30x3,50			D 180 x 40 x 22 x 18	144,55*	158,93	174,38	174,02
M 32x1,00			D 150 x 28 x 22 x 18	408,38	433,63		
M 32x1,50			D 150 x 28 x 22 x 18	177,58	194,96	229,28	
M 32x2,00			D 150 x 28 x 22 x 18	218,20	334,11		
M 33x1,00			D 160 x 30 x 25 x 20	376,11			
M 33x1,50			D 160 x 30 x 25 x 20	200,07	212,19		246,97
M 33x2,00			D 160 x 30 x 25 x 20	327,90	335,17		409,00
M 33x3,50			D 180 x 40 x 25 x 20	173,71*	199,88		221,70
M 34x1,50			D 170 x 30 x 28 x 22	222,82	236,04		
M 34x2,00			D 160 x 30 x 28 x 22	468,60			
M 35x1,50			D 170 x 30 x 28 x 22	234,99	258,48		282,66
M 35x2,00			D 170 x 30 x 28 x 22	432,41	476,03		
M 36x1,50			D 170 x 30 x 28 x 22	214,57	253,67		307,06
M 36x2,00			D 170 x 30 x 28 x 22	289,81	301,25		
M 36x3,00			D 200 x 50 x 28 x 22	332,50	345,58		444,41
M 36x4,00			D 200 x 50 x 28 x 22	227,99*	244,25	283,71	271,46
M 38x1,50			D 170 x 30 x 28 x 22	228,74	257,73		
M 38x2,00			D 170 x 32 x 28 x 22	486,19	534,84		
M 39x1,50			D 170 x 32 x 32 x 24	359,45			
M 39x2,00			D 170 x 32 x 32 x 24	359,45			
M 39x3,00			D 200 x 47 x 32 x 24	469,40			
M 39x4,00			D 200 x 50 x 32 x 24	273,53	284,33		350,60
M 40x1,50			D 170 x 30 x 32 x 24	299,09	329,21		
M 40x2,00			D 170 x 30 x 32 x 24	360,39			
M 40x3,00			D 200 x 47 x 32 x 24	353,35	421,56		
M 42x1,50			D 170 x 30 x 32 x 24	326,35	318,95		
M 42x2,00			D 170 x 30 x 32 x 24	412,28			
M 42x3,00			D 200 x 45 x 32 x 24	412,28	493,71		
M 42x4,50			D 200 x 56 x 32 x 24	351,73	365,51		390,84
M 45x1,50			D 180 x 32 x 36 x 29	389,78	428,72		
M 45x2,00			D 180 x 32 x 36 x 29	477,38			
M 45x3,00			D 200 x 47 x 36 x 29	477,38			
M 45x4,50			D 220 x 58 x 36 x 29	384,21	422,60		
M 48x1,50			D 190 x 32 x 36 x 29	384,21			
M 48x2,00			D 190 x 32 x 36 x 29	620,81			
M 48x3,00			D 220 x 52 x 36 x 29	578,50			
M 48x5,00			D 250 x 65 x 36 x 29	472,47	519,69		
M 50x1,50			D 190 x 32 x 36 x 29	465,66			
M 52x1,50			D 190 x 32 x 40 x 32	454,90			
M 52x2,00			D 190 x 32 x 40 x 32	719,89			
M 52x3,00			D 225 x 50 x 40 x 32	739,85			
M 52x5,00			D 250 x 65 x 40 x 32	483,87	598,70		

* Consulte el precio de machos y terrajas a izquierdas disponibles en Pag.215

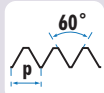
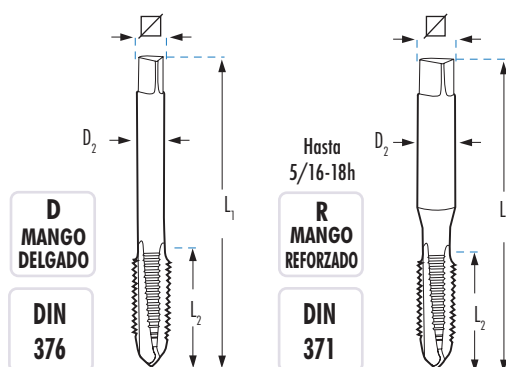
MACHOS PARA ROSCAR A MÁQUINA HSSCo

UNC

HSSCo
5%TOL
2BVc
12 m/min

 	D1 mm		L1 x L2 x D2 x ∇ mm	M1R	M2R	M4R
				FORMA C	FORMA B	 35°
				€	€	€
UNC nº 4-40h	2,84	2,25	R 56 x 11 x 3,5 x 2,7	26,92	32,01	36,53
UNC nº 5-40h	3,17	2,60	R 56 x 11 x 3,5 x 2,7	27,90	33,47	36,53
UNC nº 6-32h	3,50	2,75	R 56 x 12 x 4,0 x 3,0	26,55	31,91	36,37
UNC nº 8-32h	4,17	3,50	R 63 x 13 x 4,5 x 3,4	26,55	31,91	34,79
UNC nº 10-24h	4,83	3,90	R 70 x 15 x 6,0 x 4,9	27,90	33,47	38,21
UNC nº 12-24h	5,49	4,50	R 80 x 16 x 6,0 x 4,9	29,27	33,47	35,07
UNC 1/4-20h	6,35	5,10	R 80 x 17 x 7,0 x 5,5	26,08	28,43	32,81
UNC 5/16-18h	7,94	6,60	R 90 x 20 x 8,0 x 6,2	29,52	32,54	37,05

	MANGO DELGADO			M1D	M2D	M4D
UNC 3/8-16h	9,52	8,00	D 100 x 22 x 7,0 x 5,5	33,65	35,29	39,66
UNC 7/16-14h	11,11	9,40	D 100 x 22 x 8,0 x 6,2	46,32	46,47	58,12
UNC 1/2-13h	12,70	10,75	D 110 x 24 x 9,0 x 7,0	50,26	55,69	63,57
UNC 9/16-12h	14,28	12,20	D 110 x 26 x 11,0 x 9,0	69,09	75,86	86,30
UNC 5/8-11h	15,87	13,50	D 110 x 27 x 12,0 x 9,0	67,13	73,88	83,93
UNC 3/4-10h	19,05	16,50	D 125 x 30 x 14,0 x 11,0	88,87	97,70	111,16
UNC 7/8-9h	22,22	19,50	D 140 x 32 x 18,0 x 14,5	116,94	128,48	173,94
UNC 1"-8h	25,40	22,25	D 160 x 36 x 18,0 x 14,5	154,52	168,80	218,20
UNC 1.1/8-7h	28,57	25,00	D 180 x 40 x 22,0 x 18,0	201,83		243,80
UNC 1.1/4-7h	31,75	28,00	D 180 x 40 x 22,0 x 18,0	236,57		311,89
UNC 1.3/8-6h	34,92	30,75	D 200 x 50 x 28,0 x 22,0	352,86		
UNC 1.1/2-6h	38,10	34,00	D 200 x 50 x 32,0 x 24,0	400,72		

MACHOS PARA ROSCAR A MÁQUINA HSSCo

UNF

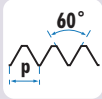

HSSCo
5%

TOL
2B

Vc
12 m/min

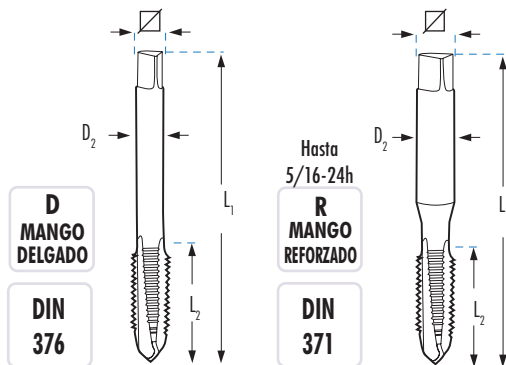

UNF nº	D1 mm	D2 mm	R	L1 x L2 x D2 x mm	M1R	M2R	M4R
					FORMA C	FORMA B	35°
					€	€	€
UNF nº 4-48h	2,84	2,35	R	56 x 11 x 3,5 x 2,7	28,18	30,68	38,51
UNF nº 5-44h	3,17	2,70	R	56 x 11 x 3,5 x 2,7	28,18	30,68	38,51
UNF nº 6-40h	3,50	2,95	R	56 x 12 x 4,0 x 3,0	26,95	32,28	38,22
UNF nº 8-36h	4,17	3,50	R	63 x 13 x 4,5 x 3,4	26,95	32,28	38,22
UNF nº 10-32h	4,83	4,10	R	70 x 15 x 6,0 x 4,9	26,95	32,28	38,22
UNF nº 12-28h	5,49	4,60	R	80 x 16 x 6,0 x 4,9	28,18	33,77	38,51
UNF 1/4-28h	6,35	5,50	R	80 x 17 x 7,0 x 5,5	22,76	24,38	28,44
UNF 5/16-24h	7,94	6,90	R	90 x 20 x 8,0 x 6,2	25,45	28,06	32,80

					M1D	M2D	M4D
UNF 3/8-24h	9,52	8,50	D	90 x 16 x 7,0 x 5,5	27,87	32,24	41,03
UNF 7/16-20h	11,11	9,90	D	100 x 22 x 8,0 x 6,2	34,38	39,85	52,61
UNF 1/2-20h	12,70	11,50	D	100 x 22 x 9,0 x 7,0	36,60	42,37	55,97
UNF 9/16-18h	14,29	12,90	D	100 x 22 x 11,0 x 9,0	44,97	52,08	69,30
UNF 5/8-18h	15,87	14,50	D	100 x 22 x 12,0 x 9,0	50,63	58,58	77,43
UNF 3/4-16h	19,05	17,50	D	110 x 25 x 14,0 x 11,0	64,79	75,02	99,04
UNF 7/8-14h	22,22	20,40	D	125 x 25 x 18,0 x 14,5	81,47	101,91	151,49
UNF 1"-12h	25,40	23,25	D	140 x 28 x 18,0 x 14,5	122,63	133,53	178,30
UNS 1"-14h	25,40	23,60	D	140 x 28 x 18,0 x 14,5	123,18	137,36	178,31
UNF 1.1/8-12h	28,57	26,50	D	150 x 28 x 22,0 x 18,0	186,85		
UNF 1.1/4-12h	31,75	29,50	D	150 x 28 x 22,0 x 18,0	236,12		
UNF 1.1/2-12h	38,10	36,00	D	170 x 30 x 32,0 x 24,0	396,29		

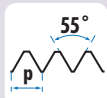
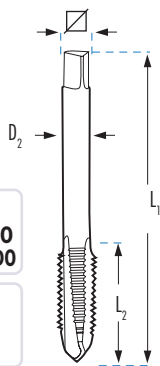
MACHOS PARA ROSCAR A MÁQUINA HSSCo
**BSP
(GAS)**

**HSSCo
5%**
**TOL
ISO 228**
INOX
**Vc
12 m/min**
**Vc
6 m/min**

**D
MANGO
DELGADO**
**DIN
5156**

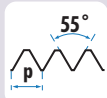

				L1 x L2 x D2 x ∇ mm	M1D	M2D	M3D	M4D	M2DX	M4DX
					FORMA C	FORMA B	15°	35°	FORMA B	35°
					€	€	€	€	€	€
G 1/8-28h.	9,728	8,80	D	90 x 16 x 7 x 5,5	35,64 *	40,71	41,71	43,22	62,93	62,28
G 1/4-19h.	13,157	11,80	D	100 x 22 x 11 x 9,0	49,42 *	54,41	59,89	62,07	84,78	90,74
G 3/8-19h.	16,662	15,25	D	100 x 22 x 12 x 9,0	59,18 *	65,11	71,54	74,12	100,58	106,64
G 1/2-14h.	20,955	19,00	D	125 x 25 x 16 x 12,0	74,79 *	82,30	90,23	93,47	124,53	134,60
G 5/8-14h.	22,911	21,00	D	125 x 25 x 18 x 14,5	93,20 *	97,74	112,34	111,30		
G 3/4-14h.	26,441	24,50	D	140 x 28 x 20 x 16,0	117,06	128,85	141,23	146,33	188,16	207,59
G 7/8-14h.	30,201	28,25	D	150 x 28 x 22 x 18,0	157,36	165,54	189,95	188,17		
G 1"-11h.	33,249	30,75	D	160 x 30 x 25 x 20,0	181,71	199,84	216,86	224,70		
G 1.1/8-11h.	37,897	35,50	D	170 x 30 x 28 x 22,0	290,16	316,50		347,61		
G 1.1/4-11h.	41,910	39,50	D	170 x 30 x 32 x 24,0	340,46	358,22		396,56		
G 1.3/8-11h.	44,323	42,00	D	180 x 32 x 36 x 29,0	407,12			550,85		
G 1.1/2-11h.	47,803	45,25	D	190 x 32 x 36 x 29,0	542,89	756,81		716,95		
G 1.3/4-11h.	53,746	51,25	D	190 x 32 x 40 x 32,0	645,29	746,53				
G 2"-11h.	59,614	57,00	D	220 x 36 x 45 x 35,0	823,00	819,19				

* Disponibles también con rosca izquierda con 100% de recargo sobre los precios tarifados en rosca derecha

BSF

**HSSCo
5%**
**TOL
ISO 228**
**Vc
12 m/min**
**D
MANGO
DELGADO**
**DIN
5156**

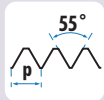
			L1 x L2 x D2 x ∇ mm	M1D
				FORMA C
				€
BSF 3/16-32h.	4,762	4,00	D 70 x 16 x 3,5 x 2,7	81,54
BSF 1/4-26h.	6,350	5,20	D 80 x 17 x 4,5 x 3,4	35,68
BSF 5/16-22h.	7,938	6,60	D 90 x 20 x 6,0 x 4,9	42,37
BSF 3/8-20h.	9,525	8,10	D 100 x 22 x 7,0 x 5,5	44,54
BSF 7/16-18h.	11,113	9,50	D 100 x 22 x 8,0 x 6,2	60,03
BSF 1/2-16h.	12,700	11,00	D 110 x 24 x 9,0 x 7,0	67,94
BSF 9/16-16h.	14,287	12,50	D 110 x 25 x 11,0 x 9,0	71,90
BSF 5/8-14h.	15,876	14,00	D 110 x 27 x 12,0 x 9,0	95,83
BSF 3/4-12h.	19,051	16,50	D 125 x 30 x 14,0 x 11,0	113,44
BSF 7/8-11h.	22,226	19,50	D 140 x 32 x 18,0 x 14,5	157,66
BSF 1"-10h.	25,400	22,50	D 160 x 36 x 18,0 x 14,5	183,27

MACHOS PARA ROSCAR A MÁQUINA HSSCo



HSSCo
5%

TOL
Clase 2

Vc
12 m/min

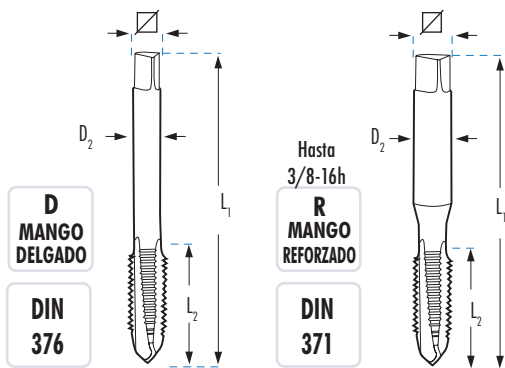

Icono	D1 mm	Ø	L1 x L2 x D2 x mm	M1R	M2R	M3R	M4R
				FORMA C	FORMA B	15°	35°
				€	€	€	€
W 3/32-48h.	2,38	1,80	R 50 x 9 x 2,8 x 2,1	24,77	26,44		
W 1/8-40h.	3,17	2,55	R 56 x 11 x 3,5 x 2,7	20,66 *	22,84	26,96	25,95
W 5/32-32h.	3,97	3,10	R 63 x 13 x 4,5 x 3,4	20,66	22,84	26,96	25,95
W 3/16-24h.	4,76	3,60	R 70 x 15 x 6,0 x 4,9	22,93	22,84	26,96	25,95
W 7/32-24h.	5,56	4,40	R 80 x 16 x 6,0 x 4,9	31,37	33,17		
W 1/4-20h.	6,35	5,10	R 80 x 17 x 7,0 x 5,5	22,07	25,95	30,61	31,71
W 5/16-18h.	7,94	6,50	R 90 x 20 x 8,0 x 6,2	24,75	32,72	35,72	35,66
W 3/8-16h.	9,52	7,90	R 100 x 22 x 10,0 x 8,0	27,70	36,16	39,70	39,64

MANGO DELGADO				M1D	M2D	M3D	M4D
W 7/16-14h.	11,11	9,25	D 100 x 22 x 8,0 x 6,2	38,52	39,83	50,04	50,40
W 1/2-12h.	12,70	10,50	D 110 x 24 x 9,0 x 7,0	36,94	41,53	47,94	48,29
W 9/16-12h.	14,29	12,00	D 110 x 26 x 11,0 x 9,0	52,95	54,99	68,76	69,25
W 5/8-11h.	15,87	13,40	D 110 x 27 x 12,0 x 9,0	50,14	51,95	65,03	65,48
W 3/4-10h.	19,05	16,50	D 125 x 30 x 14,0 x 11,0	70,17	72,84	87,12	87,74
W 7/8-9h.	22,22	19,25	D 140 x 32 x 18,0 x 14,5	90,89	94,25	117,93	113,56
W 1"-8h.	25,40	21,75	D 160 x 36 x 18,0 x 14,5	114,23	118,46	147,99	149,04
W 1.1/8-7h.	28,57	24,75	D 180 x 40 x 22,0 x 18,0	154,92	176,52	212,25	
W 1.1/4-7h.	31,75	27,75	D 180 x 40 x 22,0 x 18,0	225,05	256,48		
W 1.3/8-6h.	34,92	30,50	D 200 x 50 x 28,0 x 22,0	369,90	421,19		
W 1.1/2-6h.	38,10	33,50	D 200 x 50 x 32,0 x 24,0	401,50	457,58		
W 1.5/8-5h.	41,27	46,50	D 220 x 65 x 32,0 x 24,0	560,42	638,72		
W 1.3/4-5h.	44,45	39,00	D 220 x 58 x 36,0 x 29,0	600,27	689,06		
W 1.7/8-4,5h.	47,62	42,00	D 250 x 75 x 36,0 x 29,0	696,03	763,89		
W 2"-4,5h.	50,80	44,50	D 250 x 65 x 40,0 x 32,0	859,12			

* Disponibles también con rosca izquierda con 100% de recargo sobre los precios tarifados en rosca derecha

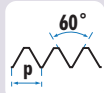
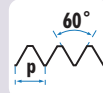
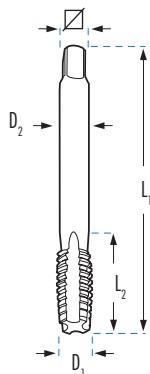
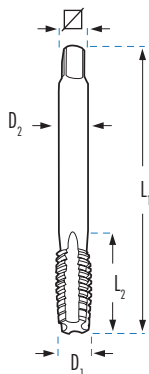
MACHOS PARA ROSCAR A MÁQUINA HSSCo
UNJC

HSSCo
5%
TOL
3B
UNJF

HSSCo
5%
TOL
3B
Vc
12 m/min

Vc
12 m/min

	D1 mm		L1 x L2 x D2 x ∇ mm	M1R
				FORMA C
				€
UNJC nº 4-40h	2,84	2,25	R 56 x 11 x 3,5 x 2,7	40,89
UNJC nº 5-40h	3,17	2,60	R 56 x 11 x 3,5 x 2,7	40,89
UNJC nº 6-32h	3,50	2,75	R 56 x 12 x 4,0 x 3,0	40,89
UNJC nº 8-32h	4,17	3,50	R 63 x 13 x 4,5 x 3,4	40,89
UNJC nº10-24h	4,83	3,90	R 70 x 15 x 6,0 x 4,9	40,89
UNJC nº12-24h	5,49	4,50	R 80 x 16 x 6,0 x 4,9	42,89
UNJC 1/4-20h	6,35	5,10	R 80 x 17 x 7,0 x 5,5	38,16
UNJC 5/16-18h	7,94	6,60	R 90 x 20 x 8,0 x 6,2	43,18
UNJC 3/8-16h	9,52	8,00	R 100 x 22 x 8,0 x 6,2	49,22

	D1 mm		L1 x L2 x D2 x ∇ mm	M1R
				FORMA C
				€
UNJF nº 4-48h	2,84	2,35	R 56 x 11 x 3,5 x 2,7	44,86
UNJF nº 5-44h	3,17	2,70	R 56 x 11 x 3,5 x 2,7	44,86
UNJF nº 6-40h	3,50	2,95	R 56 x 12 x 4,0 x 3,0	44,86
UNJF nº 8-36h	4,17	3,50	R 63 x 13 x 4,5 x 3,4	44,86
UNJF nº10-32h	4,83	4,10	R 70 x 15 x 6,0 x 4,9	44,86
UNJF nº12-28h	5,49	4,60	R 80 x 16 x 6,0 x 4,9	44,86
UNJF 1/4-28h	6,35	5,50	R 80 x 17 x 7,0 x 5,5	34,83
UNJF 5/16-24h	7,94	6,90	R 90 x 20 x 8,0 x 6,2	38,94
UNJF 3/8-24h	9,52	8,50	R 90 x 16 x 7,0 x 6,2	42,64

MANGO DELGADO PASOS NORMALES			M1D
UNJC 7/16-14h	11,11	9,40	D 110 x 24 x 9,0 x 7,0 67,88
UNJC 1/2-13h	12,70	10,75	D 110 x 26 x 11,0 x 9,0 73,68
UNJC 9/16-12h	14,28	12,20	D 110 x 27 x 12,0 x 9,0 101,27
UNJC 5/8-11h	15,87	13,50	D 110 x 27 x 12,0 x 9,0 103,81
UNJC 3/4-10h	19,05	16,50	D 125 x 30 x 14,0 x 11,0 130,25
UNJC 7/8-9h	22,22	19,50	D 140 x 32 x 18,0 x 14,5 171,39
UNJC 1"-8h	25,40	22,25	D 160 x 36 x 18,0 x 14,5 226,44

MANGO DELGADO PASOS NORMALES			M1D
UNJF 7/16-20h	11,11	9,90	D 100 x 22 x 8,0 x 6,2 58,56
UNJF 1/2-20h	12,70	11,50	D 100 x 22 x 9,0 x 7,0 62,36
UNJF 9/16-18h	14,29	12,90	D 100 x 22 x 11,0 x 9,0 76,62
UNJF 5/8-18h	15,87	14,50	D 100 x 22 x 12,0 x 9,0 86,26
UNJF 3/4-16h	19,05	17,50	D 110 x 25 x 14,0 x 11,0 110,36
UNJF 7/8-14h	22,22	20,40	D 125 x 25 x 18,0 x 14,5 138,77
UNJF 1"-12h	25,40	23,25	D 140 x 28 x 18,0 x 14,5 154,72

MACHOS PARA ROSCAR A MÁQUINA HSSCo

BSPP  **HSSCo 5%** **DIN 374** **FORMA C**

ROSCA CILÍNDRICA INGLESA PARA TUBO

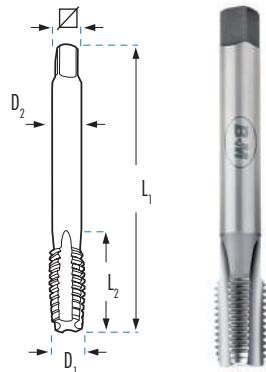

	D1 mm	L1 x L2 x D2 x ∇ mm	M1D €
Rp 1/16-28h.	7,72	D 90 x 16 x 6 x 4,9	
Rp 1/8-28h.	9,73	D 90 x 16 x 7 x 5,5	53,18
Rp 1/4-19h.	13,16	D 100 x 22 x 11 x 9,0	73,46
Rp 3/8-19h.	16,66	D 100 x 22 x 12 x 9,0	87,96
Rp 1/2-14h.	20,95	D 125 x 25 x 16 x 12,0	111,16
Rp 3/4-14h.	26,44	D 140 x 28 x 20 x 16,0	174,07
Rp 1"-11h.	33,25	D 160 x 30 x 25 x 20,0	270,08
Rp 1.1/4-11h.	41,91	D 170 x 30 x 32 x 24,0	
Rp 1.1/2-11h.	46,80	D 190 x 32 x 36 x 29,0	
Rp 2"-11h.	59,61	D 220 x 36 x 45 x 35,0	

BSPT  **HSSCo 5%** **DIN 5156** **FORMA C**

ROSCA CÓNICA INGLESA PARA TUBO

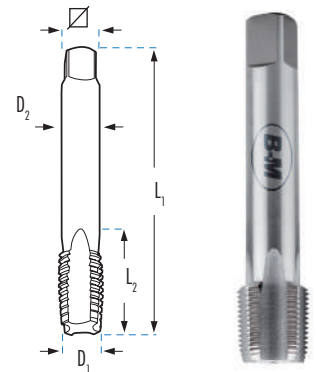

	D1 mm	∇	L1 x L2 x D2 x ∇ mm	M1D €
Rc 1/16-28h.	7,72		D 90 x 14 x 6 x 4	
Rc 1/8-28h.	9,73	8,30	D 90 x 15 x 7 x 5	54,41
Rc 1/4-19h.	13,16	11,00	D 100 x 19 x 11 x 9	78,26
Rc 3/8-19h.	16,66	14,50	D 100 x 21 x 12 x 9	108,76
Rc 1/2-14h.	20,95	18,10	D 125 x 26 x 16 x 12	151,12
Rc 5/8-14h.	22,91	21,00	D 140 x 36 x 18 x 19	243,77
Rc 3/4-14h.	26,44	23,50	D 140 x 28 x 20 x 16	235,69
Rc 7/8-14h.	30,20	28,25	D 160 x 36 x 22 x 18	410,13
Rc 1"-11h.	33,25	29,60	D 160 x 33 x 25 x 20	337,80

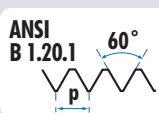
NPS (M)  **HSSCo 5%** **DIN 374** **FORMA C**

ROSCA CILÍNDRICA AMERICANA PARA TUBO

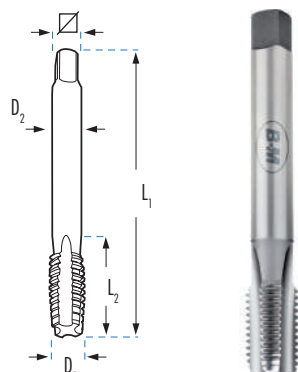

	D1 mm	∇	L1 x L2 x D2 x ∇ mm	M1D €
NPS 1/8-27h.	10,20	8,90	D 90 x 16 x 7 x 5,5	136,98
NPS 1/4-18h.	13,60	11,70	D 100 x 22 x 11 x 9,0	196,06
NPS 3/8-18h.	17,00	15,00	D 100 x 22 x 12 x 9,0	268,85
NPS 1/2-14h.	21,20	18,60	D 125 x 25 x 16 x 12,0	368,67
NPS 3/4-14h.	26,55	24,00	D 140 x 28 x 20 x 16,0	545,00
NPS 1"-11,5h.	33,20	30,00	D 160 x 30 x 25 x 20,0	704,79
NPS 1.1/4-11,5h.	41,60		D 170 x 30 x 32 x 24,0	
NPS 1.1/2-11,5h.	47,68		D 190 x 32 x 36 x 29,0	
NPS 2"-11,5h.	59,71		D 220 x 36 x 45 x 35,0	

NPT  **HSSCo 5%** **DIN 374** **FORMA C**

ROSCA CÓNICA AMERICANA PARA TUBO

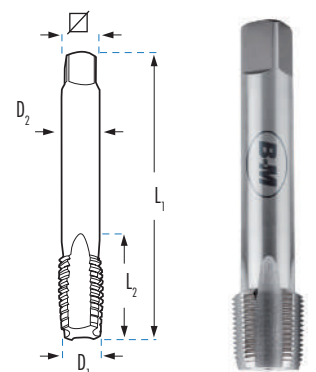

	D1 mm	∇	L1 x L2 x D2 x ∇ mm	M1D €
NPT 1/16-27h.	7,89	6,2	D 90 x 14 x 6 x 5	47,66
NPT 1/8-27h.	10,24	8,5	D 90 x 15 x 8 x 6	49,84
NPT 1/4-18h.	13,62	11,0	D 100 x 19 x 11 x 9	64,37
NPT 3/8-18h.	17,05	14,5	D 100 x 21 x 12 x 9	82,74
NPT 1/2-14h.	21,22	17,8	D 125 x 26 x 16 x 12	107,64
NPT 3/4-14h.	26,57	23,0	D 140 x 28 x 20 x 16	166,77
NPT 1"-11,5h.	33,23	29,0	D 160 x 33 x 25 x 20	216,76
NPT 1.1/4-11,5h.	41,98	37,5	D 170 x 36 x 32 x 24	295,95
NPT 1.1/2-11,5h.	48,05	44,0	D 190 x 37 x 36 x 29	466,01
NPT 2"-11,5h.	60,09	56,0	D 220 x 41 x 45 x 35	730,99

MACHOS PARA ROSCAR A MÁQUINA HSSCo

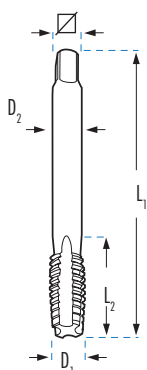
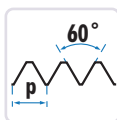
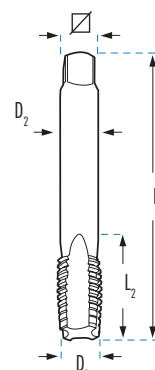
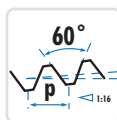
NPSF**HSSCo**
5%**DIN**
374**FORMA**
CROSCA PARA TUBO
AMERICANA CILÍNDRICA**NPTF****HSSCo**
5%**DIN**
374**FORMA**
CROSCA PARA TUBO
AMERICANA CÓNICA ESTANCA

				M1D
				€
NPSF 1/8-27h.	10,05	8,75	D 90 x 16 x 7 x 5,5	171,59
NPSF 1/4-18h.	13,33	11,30	D 100 x 22 x 11 x 9,0	236,51
NPSF 3/8-18h.	16,78	14,70	D 100 x 22 x 12 x 9,0	336,46
NPSF 1/2-14h.	20,87	18,20	D 125 x 25 x 16 x 12,0	419,58
NPSF 3/4-14h.	26,23	23,50	D 140 x 28 x 20 x 16,0	686,70
NPSF 1"-11,5h.	32,81	29,50	D 160 x 30 x 25 x 20,0	

				M1D
				€
NPTF 1/16-27h.	7,87	6,20	D 90 x 14 x 12,0 x 6	
NPTF 1/8-27h.	10,22	8,50	D 90 x 15 x 12,0 x 7	115,93
NPTF 1/4-18h.	13,58	11,00	D 100 x 21 x 17,5 x 11	162,65
NPTF 3/8-18h.	17,02	14,50	D 110 x 21 x 17,6 x 12	208,94
NPTF 1/2-14h.	21,21	17,80	D 140 x 27 x 22,8 x 16	272,00
NPTF 3/4-14h.	26,56	23,00	D 140 x 27 x 23,0 x 20	421,39

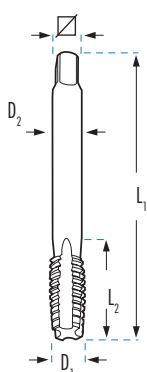
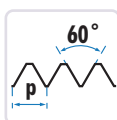
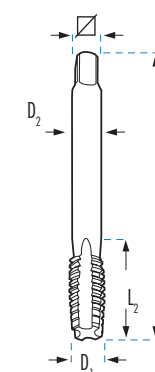
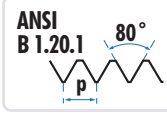
MF**HSSCo**
5%**TOL**
6H**FORMA**
C**DIN**
374ROSCA MÉTRICA FINA PARA
TUBO DE CONDUCCIÓN
ELÉCTRICA EN 60423**PG****HSSCo**
5%**DIN**
40430**FORMA**
CROSCA PARA TUBO
DE CONDUCCIÓN
ELÉCTRICA

				M1D
				€
MF 12 x 1,50	12	10,5	D 100 x 22 x 9 x 7,0	29,25
MF 16 x 1,50	16	14,5	D 100 x 22 x 12 x 9,0	41,19
MF 20 x 1,50	20	18,5	D 125 x 25 x 16 x 12,0	61,77
MF 25 x 1,50	25	23,5	D 140 x 28 x 18 x 14,5	142,28
MF 32 x 1,50	32	30,5	D 150 x 28 x 22 x 18,0	177,58
MF 40 x 1,50	40	38,5	D 170 x 30 x 32 x 24,0	299,09
MF 50 x 1,50	50	48,5	D 190 x 32 x 36 x 29,0	465,66
MF 63 x 1,50	63	61,5	D 275 x 36 x 50 x 39,0	

				M1D
				€
PG 7 - 20h.	12,5	11,50	D 100 x 22 x 9 x 7,0	50,87
PG 9 - 18h.	15,2	14,00	D 100 x 22 x 12 x 9,0	70,46
PG 11 - 18h.	18,6	17,25	D 110 x 25 x 14 x 11,0	91,67
PG 13,5 - 18h.	20,4	19,00	D 125 x 25 x 16 x 12,0	102,94
PG 16 - 18h.	22,5	21,25	D 125 x 25 x 18 x 14,5	121,15
PG 21 - 16h.	28,3	27,00	D 150 x 28 x 22 x 18,0	192,33
PG 29 - 16h.	37,0	35,50	D 170 x 30 x 28 x 22,0	325,13
PG 36 - 16h.	47,0	45,50	D 190 x 32 x 36 x 29,0	528,03
PG 42 - 16h.	54,0	52,50	D 190 x 32 x 40 x 32,0	838,60
PG 48 - 16h.	59,3	58,00	D 220 x 36 x 45 x 35,0	1.022,32

MACHOS MÁQUINA MÉTRICA NORMA ISO 529

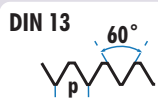
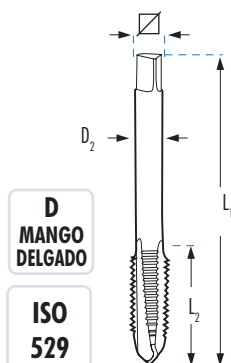
M
MFHSSCo
5%ISO
529TOL
6HD
MANGO
DELGADO

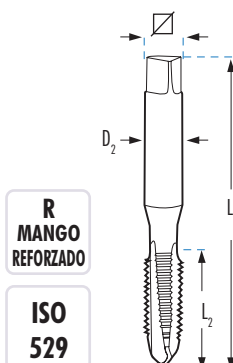
ISO
529R
MANGO
REFORZADO

ISO
529

			L1 x L2 x D2 x \square mm	M1RISO	M2RISO	M4RISO	M5RISO
				FORMA C	FORMA B	35°	DIEN TE ALTE RNO AI
				€	€	€	€
M 3x0,50	2,50	R	48 x 11 x 3,15 x 2,50	8,58	8,95	10,77	12,81
M 4x0,70	3,30	R	53 x 13 x 4,00 x 3,15	8,58	8,95	10,77	12,81
M 5x0,80	4,20	R	58 x 16 x 5,00 x 4,00	8,58	8,95	10,77	12,81
M 6x1,00	5,00	R	66 x 19 x 6,30 x 5,00	8,58	8,95	11,00	12,81
M 7x1,00	6,00	R	66 x 19 x 7,10 x 5,60		12,73	14,61	
M 8x1,00	7,00	R	69 x 19 x 8,00 x 6,30		17,56	18,02	
M 8x1,25	6,75	R	72 x 22 x 8,00 x 6,30	11,47	11,94	12,35	14,00
M 9x1,25	7,75	R	76 x 20 x 10,00 x 8,00		18,99	21,69	
M 10x1,00	9,00	R	76 x 20 x 10,00 x 8,00		20,14	22,00	
M 10x1,25	8,80	R	76 x 20 x 10,00 x 8,00		24,08	24,85	
M 10x1,50	8,50	R	80 x 24 x 10,00 x 8,00	14,58	15,19	15,92	17,66
MANGO DELGADO				M1DISO	M2DISO	M4DISO	M5DISO
M 12x1,00	11,00	D	84 x 24 x 9,00 x 7,10		27,74	28,42	
M 12x1,25	10,75	D	84 x 24 x 9,00 x 7,10		27,25	28,21	
M 12x1,50	10,50	D	89 x 29 x 9,00 x 7,10		24,31	26,18	
M 12x1,75	10,20	D	89 x 29 x 9,00 x 7,10	18,74	19,52	20,67	26,42
M 14x1,00	13,00	D	90 x 25 x 11,20 x 9,00		34,74	43,22	
M 14x1,25	12,80	D	90 x 25 x 11,20 x 9,00		29,34	36,74	
M 14x1,50	12,50	D	95 x 30 x 12,50 x 9,00		25,78	28,97	
M 14x2,00	12,00	D	95 x 30 x 11,20 x 9,00	22,41	23,34	28,26	
M 16x1,00	15,00	D	95 x 25 x 12,50 x 10,00		44,21	56,89	
M 16x1,25	14,75	D	102 x 32 x 12,50 x 10,00		49,01	63,08	
M 16x1,50	14,50	D	102 x 32 x 14,00 x 10,00		30,94	34,67	
M 16x2,00	14,00	D	102 x 32 x 12,50 x 10,00	27,83	28,98	32,78	
M 18x1,50	16,50	D	104 x 29 x 14,00 x 11,20		40,88	55,86	
M 18x2,50	15,50	D	112 x 37 x 14,00 x 11,20	41,90	43,64	54,56	
M 20x1,50	18,50	D	104 x 29 x 14,00 x 11,20		52,61	64,34	
M 20x2,50	17,50	D	112 x 37 x 14,00 x 11,20	46,83	48,78	60,97	
M 22x2,50	19,50	D	118 x 38 x 16,00 x 12,50	54,15	56,41	70,51	
M 24x3,00	21,00	D	130 x 45 x 18,00 x 14,00	61,17	63,72	79,64	
M 27x3,00	24,00	D	135 x 45 x 20,00 x 16,00	75,33	78,47	98,09	
M 30x3,50	26,50	D	138 x 48 x 20,00 x 16,00	111,92	116,59	145,73	

MACHOS MÁQUINA CORTOS DIN 352

M
MF

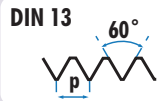

HSS

HSSCo
5%

DIN
352

TOL
6H

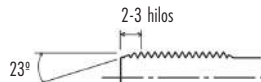

Ref. M03: Cono de entrada 2-3 hilos

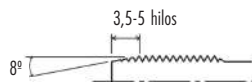

Ref. M02AT: Cono de entrada 3,5-5 hilos

D
MANGO
DELGADO

DIN
352

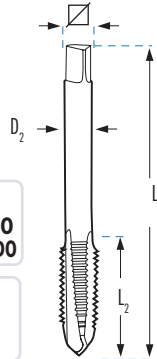

		$L_1 \times L_2 \times D_2 \times \nabla$ mm	M03	M02AT	M03X	M02DIN	M04DIN
			HSS €	ALTURA TERMINADA HSS €	INOX HSSCo €	FORMA B HSS €	 35° HSS €
M 3x0,50	2,50	D 40 x 11 x 3,50 x 2,70	7,58	10,43	13,53	9,84	11,85
M 4x0,70	3,30	D 45 x 13 x 4,50 x 3,40	7,57	10,42	13,53	9,84	11,85
M 5x0,80	4,20	D 50 x 16 x 6,00 x 4,90	8,10	11,15	14,09	9,84	11,85
M 6x1,00	5,00	D 50 x 19 x 6,00 x 4,90	8,10	11,15	14,04	9,84	12,11
M 7x1,00	6,00	D 50 x 19 x 6,00 x 4,90	9,86				
M 8x1,00	7,00	D 56 x 18 x 6,00 x 4,90	13,65				
M 8x1,25	6,75	D 56 x 22 x 6,00 x 4,90	9,85	13,57	16,34	13,14	14,68
M 9x1,25	7,75	D 63 x 18 x 7,00 x 5,50	16,14				
M 10x1,00	9,00	D 63 x 18 x 7,00 x 5,50	14,62				
M 10x1,25	8,80	D 70 x 24 x 7,00 x 5,50	14,82				
M 10x1,50	8,50	D 70 x 24 x 7,00 x 5,50	12,15	16,72	21,03	16,71	18,50
M 12x1,00	11,00	D 70 x 20 x 9,00 x 7,00	25,91				
M 12x1,25	10,75	D 70 x 20 x 9,00 x 7,00	25,84				
M 12x1,50	10,50	D 70 x 20 x 9,00 x 7,00	22,02				
M 12x1,75	10,20	D 75 x 29 x 9,00 x 7,00	17,09	23,54	30,11	21,48	24,09
M 14x1,00	13,00	D 70 x 20 x 11,00 x 9,00	40,39				
M 14x1,25	12,80	D 70 x 20 x 11,00 x 9,00	31,55				
M 14x1,50	12,50	D 70 x 20 x 11,00 x 9,00	24,53				
M 14x2,00	12,00	D 80 x 30 x 11,00 x 9,00	18,91	26,03	33,34	25,67	31,09
M 16x1,00	15,00	D 70 x 20 x 12,00 x 9,00	53,58				
M 16x1,25	14,75	D 70 x 20 x 12,00 x 9,00	56,40				
M 16x1,50	14,50	D 70 x 20 x 12,00 x 9,00	30,53				
M 16x2,00	14,00	D 80 x 32 x 12,00 x 9,00	27,06		45,70	31,89	36,05
M 18x1,50	16,50	D 80 x 22 x 14,00 x 11,00	40,22				
M 18x2,50	15,50	D 95 x 40 x 14,00 x 11,00	35,71		62,41	48,01	60,02
M 20x1,50	18,50	D 80 x 22 x 16,00 x 12,00	50,37				
M 20x2,50	17,50	D 95 x 40 x 16,00 x 12,00	40,06		69,27	53,66	67,07
M 22x2,50	19,50	D 100 x 40 x 18,00 x 14,50	53,36			62,03	77,56
M 24x3,00	21,00	D 110 x 50 x 18,00 x 14,50	63,65			70,10	87,61
M 27x3,00	24,00	D 110 x 50 x 20,00 x 16,00	80,48			90,48	99,32
M 30x3,50	26,50	D 125 x 50 x 22,00 x 18,00	103,55			123,93	127,28

MACHOS DE MÁQUINA Y COJINETES SERIE *Plus* Y *Super Plus*

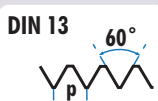

TOL
6H

PARA TRABAJOS DE ALTA PRODUCCIÓN
FABRICADOS EN ACERO SINTERIZADO

DIN
22568

TOL
6g

Vc
14 m/min

Vc
16 m/min

Vc
17 m/min

Vc
20 m/min

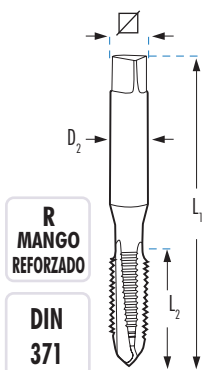
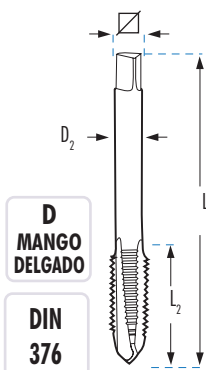

Plus *Plus* TiN *Plus* LUBE *Super Plus* ALTiN

CALIDAD	M2RP		M4RP		M2RT		M4RT		M2RHL		M4RHL		M2RSP		M4RSP		C5P
	★★	★★	★★★	★★★	★★★★	★★★★	★★★★	★★★★	★★★★	★★★★	★★★★	★★★★	★★★★	★★★★	★★★★	★★★★	
MATERIAL	HSS PM		HSS PM		HSSCo 5%		HSSCo 5%		HSS PM		HSS PM		HSS V3		HSS V3		HSS
ACABADO	BRILLANTE		BRILLANTE		TiN		TiN		HARD LUBE		HARD LUBE		ALTiN		ALTiN		BRILLANTE
ÁNGULO DE HÉLICE	FORMA B		FORMA B		FORMA B		FORMA B		FORMA B		FORMA B		FORMA B		FORMA B		
	L1 x L2 x D2 x mm		L1 x L2 x D2 x mm		L1 x L2 x D2 x mm		L1 x L2 x D2 x mm		L1 x L2 x D2 x mm		L1 x L2 x D2 x mm		L1 x L2 x D2 x mm		L1 x L2 x D2 x mm		Ø x L3 mm
	€		€		€		€		€		€		€		€		€
M 3x0,50	2,50	R	56 x 11 x 3,5 x 2,7	17,59	21,74	23,68	26,17	31,71	34,32	42,61	44,59	25 x 9	32,36				
M 4x0,70	3,30	R	63 x 13 x 4,5 x 3,4	17,97	21,74	24,06	27,29	32,19	34,80	42,61	44,59	25 x 9	32,36				
M 5x0,80	4,20	R	70 x 16 x 6,0 x 4,9	17,97	20,83	24,06	27,29	32,19	34,80	45,00	46,25	25 x 9	32,36				
M 6x1,00	5,00	R	80 x 17 x 6,0 x 4,9	19,76	22,88	27,70	30,00	35,34	36,84	45,00	46,25	25 x 9	32,36				
M 8x1,00	7,00	D	90 x 20 x 6,0 x 4,9	28,20	33,46	39,71	44,19	53,61	59,67			25 x 9	45,13				
M 8x1,25	6,80	R	90 x 20 x 8,0 x 6,2	23,13	26,58	32,38	35,22	44,94	46,88	57,13	60,88	25 x 9	35,10				
M 10x1,00	9,00	D	90 x 16 x 7,0 x 5,5	31,44	39,42	46,39	53,26	62,60	73,96			30 x 10	55,16				
M 10x1,50	8,50	R	100 x 22 x 10,0 x 8,0	27,22	30,94	38,14	41,76	55,73	58,34	68,08	72,63	30 x 10	48,27				
MANGO DELGADO			M2DP	M4DP	M2DT	M4DT	M2DHL	M4DHL	M2DSP	M4DSP							
M 12x1,50	10,50	D	100 x 22 x 9,0 x 7,0	37,30	45,09	50,24	56,56	67,52	77,44			38 x 10	57,34				
M 12x1,75	10,20	D	110 x 24 x 9,0 x 7,0	35,08	41,66	47,02	53,01	58,83	70,61	85,66	92,93	38 x 14	50,63				
M 14x1,50	12,50	D	100 x 22 x 11,0 x 9,0	44,19	55,42	59,08	65,26	79,41	91,07			38 x 10	59,94				
M 14x2,00	12,00	D	110 x 26 x 11,0 x 9,0	43,86	50,84	58,02	63,79	80,25	88,21	87,45	117,75	38 x 14	51,61				
M 16x1,50	14,50	D	100 x 22 x 12,0 x 9,0	55,28	68,16	71,01	81,19	78,41	91,53			45 x 14	82,34				
M 16x2,00	14,00	D	110 x 27 x 12,0 x 9,0	51,58	61,45	66,24	73,23	91,62	101,26	119,37	126,99	45 x 18	69,33				
M 18x2,50	15,50	D	125 x 30 x 14,0 x 11,0	73,11	82,59	90,46	98,69	129,43	137,52	177,19	191,70	45 x 18	69,33				
M 20x2,50	17,50	D	140 x 32 x 16,0 x 12,0	78,99	88,04	103,10	111,07	135,99	154,83	188,84	199,61	45 x 18	69,33				
M 22x2,50	19,50	D	140 x 32 x 18,0 x 14,5	95,56	108,64	116,52	124,72	159,50	174,05			55 x 22	103,06				
M 24x3,00	21,00	D	160 x 34 x 18,0 x 14,5	113,62	130,06	131,29	142,66	179,72	199,07			55 x 22	103,06				

MACHOS DE MÁQUINA PARA TRABAJOS ESPECIALES HSS-PM

INOX

M

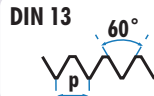

**TOL
6H**

**Vc
6 m/min**

**Vc
10 m/min**

**Vc
12 m/min**

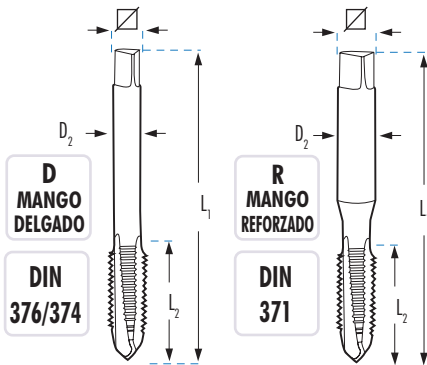

				M2RX	M4RX	M2RXT	M4RXT	M2RXHL	M4RXHL
CALIDAD				★★	★★	★★★	★★★	★★★★	★★★★
MATERIAL				HSS PM	HSS PM	HSSCo 5%	HSSCo 5%	HSS PM	HSS PM
ACABADO				OX	OX	TiN	TiN	HARD LUBE	HARD LUBE
ÁNGULO DE HÉLICE				FORMA B	FORMA B 35°	FORMA B	FORMA B 35°	FORMA B	FORMA B 35°
			$L_1 \times L_2 \times D_2 \times \angle$ mm	€	€	€	€	€	€
M 3x0,50	2,50	R	56 x 11 x 3,5 x 2,7	21,02	24,98	24,28	27,47	32,11	37,76
M 4x0,70	3,30	R	63 x 13 x 4,5 x 3,4	22,07	24,98	25,46	27,92	33,73	38,75
M 5x0,80	4,20	R	70 x 16 x 6,0 x 4,9	22,07	25,17	25,46	28,34	33,73	39,33
M 6x1,00	5,00	R	80 x 17 x 6,0 x 4,9	24,18	27,22	26,96	29,63	36,93	41,15
M 8x1,00	7,00	D	90 x 20 x 6,0 x 4,9	39,04	42,78				
M 8x1,25	6,80	R	90 x 20 x 8,0 x 6,2	26,97	31,01	31,16	34,14	41,23	47,39
M 10x1,00	9,00	D	90 x 16 x 7,0 x 5,5	40,24	42,96				
M 10x1,50	8,50	R	100 x 22 x 10,0 x 8,0	32,99	36,79	36,44	40,26	50,38	56,20
MANGO DELGADO				M2DX	M4DX	M2DXT	M4DXT	M2DXHL	M4DXHL
M 12x1,00	11,00	D	100 x 22 x 9,0 x 7,0	45,63	52,35				
M 12x1,50	10,50	D	100 x 22 x 9,0 x 7,0	46,32	54,77				
M 12x1,75	10,20	D	110 x 24 x 9,0 x 7,0	42,39	49,63	46,61	52,47	66,34	77,66
M 14x2,00	12,00	D	110 x 26 x 11,0 x 9,0	60,34	69,12	60,72	65,64	88,15	97,61
M 16x2,00	14,00	D	110 x 27 x 12,0 x 9,0	67,20	79,77	68,92	75,53	98,14	118,06
M 18x2,50	15,50	D	125 x 30 x 14,0 x 11,0	100,63	113,51	103,90	107,81	157,49	167,97
M 20x2,50	17,50	D	140 x 32 x 16,0 x 12,0	108,75	119,87	118,63	121,80	167,43	177,36
M 22x2,50	19,50	D	140 x 32 x 18,0 x 14,5	130,49	137,88	147,26	159,44		
M 24x3,00	21,00	D	160 x 34 x 18,0 x 14,5	137,19	157,47	150,13	163,09		
M 27x3,00	24,00	D	160 x 36 x 20,0 x 16,0	179,71	206,27				
M 30x3,50	26,50	D	180 x 40 x 22,0 x 18,0	229,81	263,78				



- Lubricación: **CUT MAGIC XTHICK**
- Se recomienda la aplicación del Aceite de corte CUT MAGIC XTHICK para optimizar el proceso de roscado en Inoxidables, Inconel, Titanio, Dúplex, etc...

Ref. ACXT00250

MACHOS *Super Plus* PARA EL ROSCADO DE ALEACIONES REFRACTARIAS

M

DIN 13

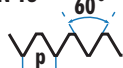
TOL
6HINOX
DUPLEX

Ni

INC

Ti

 ESPECIALMENTE RECOMENDADOS
 EN APLICACIONES AERONÁUTICAS
Vc
15
m/minINOX
DUPLEXVc
6
m/minNICKEL
INCONELVc
6
m/min

TITANIO

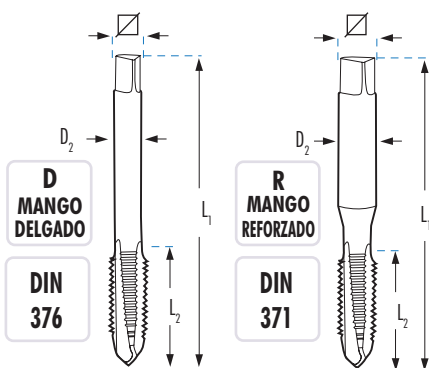

			M2RDU	M4RDU	M2RNI	M3RNI	M2RTIT	M3RTIT
CALIDAD			★★★★	★★★★	★★★★	★★★★	★★★★	★★★★
MATERIAL			HSS V3	HSS V3	HSS PM	HSS PM	HSS PM	HSS PM
ACABADO			TiCN	TiCN	BRILLANTE	BRILLANTE	OX	OX
ÁNGULO DE HÉLICE			FORMA B	41°	FORMA B	15°	FORMA B	15°
		L1 x L2 x D2 x ∇ mm	€	€	€	€	€	€
M 3x0,50	2,50	R 56 x 11 x 3,5 x 2,7	43,21	44,26	80,27	82,03	59,60	65,78
M 4x0,70	3,30	R 63 x 13 x 4,5 x 3,4	43,21	44,53	82,03	84,25	61,46	65,78
M 5x0,80	4,20	R 70 x 16 x 6,0 x 4,9	44,66	45,53	84,92	86,93	63,01	70,07
M 6x1,00	5,00	R 80 x 17 x 6,0 x 4,9	45,89	46,86	85,59	88,01	63,01	71,04
M 8x1,25	6,80	R 90 x 20 x 8,0 x 6,2	64,09	66,82	96,73	99,30	72,81	82,03
M 10x1,50	8,50	R 100 x 22 x 10,0 x 8,0	83,07	85,23	114,92	118,44	90,17	98,85
MANGO DELGADO			M2DDU	M4DDU	M2DNI	M3DNI	M2DTIT	M3DTIT
M 12x1,75	10,20	D 110 x 24 x 9,0 x 7,0	112,30	121,26	147,82	163,44	113,17	122,81
M 14x2,00	12,00	D 110 x 26 x 11,0 x 9,0						
M 16x2,00	14,00	D 110 x 27 x 12,0 x 9,0	165,14	176,59				
M 18x2,50	15,50	D 125 x 30 x 14,0 x 11,0						
M 20x2,50	17,50	D 140 x 32 x 16,0 x 12,0	244,53	264,13				
M 22x2,50	19,50	D 140 x 32 x 18,0 x 14,5						
M 24x3,00	21,00	D 160 x 34 x 18,0 x 14,5	331,21	336,89				
M 27x3,00	24,00	D 160 x 36 x 20,0 x 16,0	425,51	446,03				
M 30x3,50	26,50	D 180 x 40 x 22,0 x 18,0	502,54	525,85				

MACHOS DE MÁQUINA PARA ACEROS ESTRUCTURALES SUPER BLANDOS < DE 450 N/mm²



HSSCo
5%

OX

TOL
6H

APLICACIONES



ST52

Al

Geometría de corte específica para materiales blandos, no genera SOBREMEDIDA y se ajusta perfectamente a este tipo de materiales donde los machos convencionales, pueden provocar agrandamientos a la hora de generar la rosca.

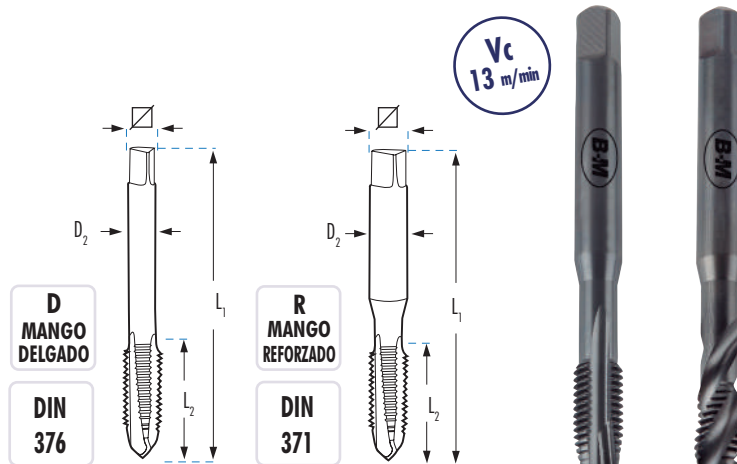





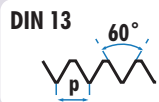
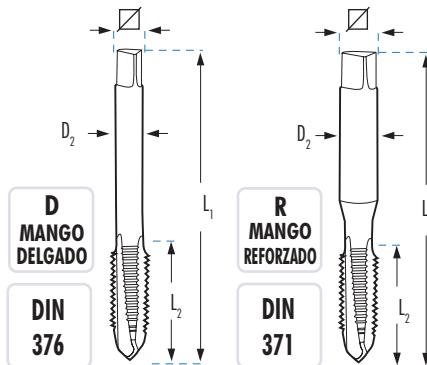

Icono	Ø	L1 x L2 x D2 x \square mm	M2RSS	M4RSS	
			FORMA B	35°	
			€	€	
M	3 x 0,50	2,50	R 56 x 11 x 3,5 x 2,7	14,97	20,00
M	4 x 0,70	3,30	R 63 x 13 x 4,5 x 3,4	15,67	20,01
M	5 x 0,80	4,20	R 70 x 16 x 6,0 x 4,9	15,69	19,19
M	6 x 1,00	5,00	R 80 x 17 x 6,0 x 4,9	17,21	21,04
M	8 x 1,25	6,80	R 90 x 20 x 8,0 x 6,2	19,31	23,80
M	10 x 1,50	8,50	R 100 x 22 x 10,0 x 8,0	23,78	28,19
MANGO DELGADO			M2DSS	M4DSS	
M	12 x 1,75	10,20	D 110 x 24 x 9,0 x 7,0	29,99	36,31
M	14 x 2,00	12,00	D 110 x 26 x 11,0 x 9,0	44,28	52,29
M	16 x 2,00	14,00	D 110 x 27 x 12,0 x 9,0	51,79	63,17
M	18 x 2,50	15,50	D 125 x 30 x 14,0 x 11,0	73,77	81,89
M	20 x 2,50	17,50	D 140 x 32 x 16,0 x 12,0	79,63	90,78
M	22 x 2,50	19,50	D 140 x 32 x 18,0 x 14,5	95,59	106,53
M	24 x 3,00	21,00	D 160 x 34 x 18,0 x 14,5	113,86	129,49
M	27 x 3,00	24,00	D 160 x 36 x 20,0 x 16,0	142,41	159,32
M	30 x 3,50	26,50	D 180 x 40 x 22,0 x 18,0	182,98	204,17

MACHOS DE MÁQUINA PARA TRABAJOS ESPECIALES HSS-V3

1200
 N/mm²

HSS
V3
TOL
6H
MATERIALES
DUROS

 Vc
 7
 m/min

 Vc
 9
 m/min

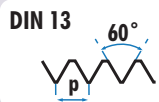
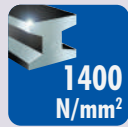
			M2RMD	M4RMD	M2RMDTX	M4RMDTX	
CALIDAD			★★★	★★★	★★★★	★★★★	
MATERIAL			HSS V3	HSS V3	HSS V3	HSS V3	
ACABADO			OX	OX	TINALOX	TINALOX	
ÁNGULO DE HÉLICE			FORMA B	 35°	FORMA B	 35°	
			L1 x L2 x D2 x 	€	€	€	€
M	3x0,50	2,50	R 56 x 11 x 3,5 x 2,7	18,45	20,20	27,06	31,82
M	4x0,70	3,30	R 63 x 13 x 4,5 x 3,4	18,51	20,27	28,43	33,32
M	5x0,80	4,20	R 70 x 16 x 6,0 x 4,9	18,51	21,26	28,43	33,32
M	6x1,00	5,00	R 80 x 17 x 6,0 x 4,9	21,01	21,97	31,14	35,04
M	8x1,25	6,80	R 90 x 20 x 8,0 x 6,2	22,45	25,92	34,76	39,95
M	10x1,50	8,50	R 100 x 22 x 10,0 x 8,0	25,86	29,85	43,98	49,06
MANGO DELGADO			M2DMD	M4DMD	M2DMDTX	M4DMDTX	
M	12x1,75	10,20	D 110 x 24 x 9,0 x 7,0	36,87	42,53	58,58	68,58
M	14x2,00	12,00	D 110 x 26 x 11,0 x 9,0	48,36	50,48	83,35	91,52
M	16x2,00	14,00	D 110 x 27 x 12,0 x 9,0	54,10	61,08	92,84	110,68
M	18x2,50	15,50	D 125 x 30 x 14,0 x 11,0	80,66	86,89	136,50	154,58
M	20x2,50	17,50	D 140 x 32 x 16,0 x 12,0	87,17	91,74	147,53	163,18

MACHOS DE MÁQUINA PARA MATERIALES TEMPLADOS (HARDOX 450/500)



TOL
6H

HSSE

HSS
PM

MD

MATERIALES
MUY
DUROS

48
HRc

48-62
HRc



MD

Vc
5 m/min

48
HRc

48-62
HRc

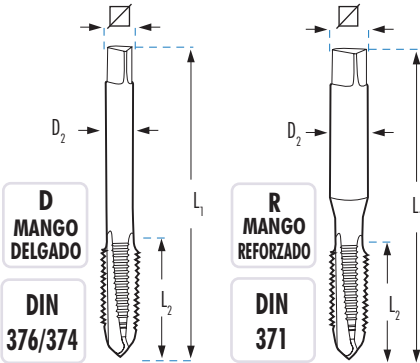

				M2RC	M3RC	M2HRC	M4HRC	M1RCM		M1RHMC	
				HSSE	HSSE	HSS PM	HSS PM	HSS PM		MD	
				TiAlN	TiAlN	TINALOX	TINALOX	TiCN		TiCN	
				FORMA B	FORMA B 15°	FORMA B	FORMA B 35°	FORMA C		FORMA C	
		L1 x L2 x D2 x ∅		€	€	€	€	€	€	€	€
M 3 x 0,50	2,50	R 56 x 11 x 3,5 x 2,7		29,52	31,40	32,64	36,56	2,60	47,28	2,60	130,98
M 4 x 0,70	3,30	R 63 x 13 x 4,5 x 3,4		29,58	33,44	33,90	37,97	3,40	41,59	3,40	130,98
M 5 x 0,80	4,20	R 70 x 16 x 6,0 x 4,9		29,86	32,68	34,23	38,34	4,30	46,47	4,30	130,98
M 6 x 1,00	5,00	R 80 x 17 x 6,0 x 4,9		32,28	36,18	35,69	39,97	5,10	59,50	5,10	163,73
M 8 x 1,25	6,80	R 90 x 20 x 8,0 x 6,2		37,28	42,54	44,37	49,71	6,90	66,00	6,90	184,26
M 10 x 1,50	8,50	R 100 x 22 x 10,0 x 8,0		44,63	52,70	53,11	55,77	8,60	85,56	8,60	282,73
		MANGO DELGADO		M2DC	M3DC	M2HDC	M4HDC	M1RCM		M1DHMC	
M 12 x 1,75	10,20	D 110 x 24 x 9,0 x 7,0		66,74	79,22	81,07	88,38	10,40	113,20 *	10,40	442,80
M 14 x 2,00	12,00	D 110 x 26 x 11,0 x 9,0		90,11	105,40	96,14	108,13	12,10	143,12 *	12,10	510,23
M 16 x 2,00	14,00	D 110 x 27 x 12,0 x 9,0		101,67	121,07	106,89	123,95	14,10	153,09 *	16,10	666,25
M 18 x 2,50	15,50	D 125 x 30 x 14,0 x 11,0		128,75	140,20	132,32	144,23			15,75	813,95
M 20 x 2,50	17,50	D 140 x 32 x 16,0 x 12,0		155,93	162,29	156,26	170,33			17,75	1.287,53
M 22 x 2,50	19,50	D 140 x 32 x 18,0 x 14,5		220,88	230,33						
M 24 x 3,00	21,00	D 160 x 34 x 18,0 x 14,5		226,13	236,63	235,97	257,22				
M 27 x 3,00	24,00	D 160 x 36 x 20,0 x 16,0		236,63	254,48						
M 30 x 3,50	26,50	D 180 x 40 x 22,0 x 18,0		253,31	268,13						

* Mango Reforzado: M12 - Ø 12 x 9
M14 - Ø 14 x 11
M16 - Ø 16 x 12





- Lubricación: **CUT MAGIC XTHICK**
- Se recomienda roscar la pieza sobre el mismo utillaje utilizado para el taladro previo y en la misma posición, para garantizar coaxialidad entre macho y orificio previo.

Ref. ACXT00250

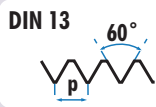
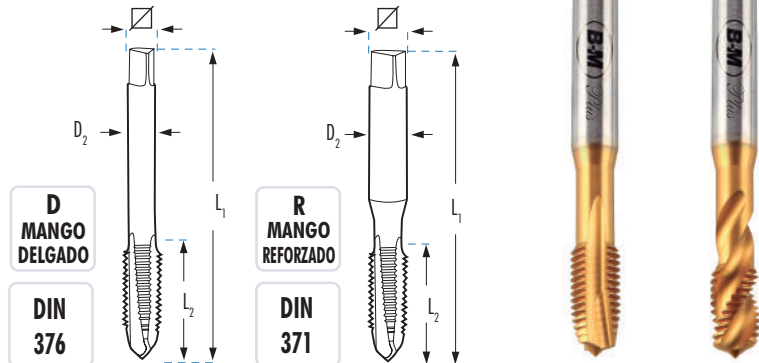
HRc	Vc (m/min)
48 Hrc	8 m/min
56 Hrc	6 m/min
62Hrc	3 m/min

MACHOS DE MÁQUINA TODO TERRENO
**TODO
TERRENO**

**HSSCo
5%**
TiN
**TOL
6H**
APLICACIONES
**1200
N/mm²**
Al
FUNDICIÓN
Ti
INOX
**Vc
13
m/min**

		L1 x L2 x D2 x ∇ mm	M2RD	M4RD
			FORMA B	 35°
			€	€
M 3 x 0,50	2,50	R 56 x 11 x 3,5 x 2,7	27,71	34,64
M 4 x 0,70	3,30	R 63 x 13 x 4,5 x 3,4	29,65	34,64
M 5 x 0,80	4,20	R 70 x 16 x 6,0 x 4,9	31,54	35,88
M 6 x 1,00	5,00	R 80 x 17 x 6,0 x 4,9	32,64	37,24
M 8 x 1,25	6,80	R 90 x 20 x 8,0 x 6,2	38,24	42,49
M 10 x 1,50	8,50	R 100 x 22 x 10,0 x 8,0	44,12	50,34
MANGO DELGADO			M2DD	M4DD
M 12 x 1,75	10,20	D 110 x 24 x 9,0 x 7,0	55,60	66,19
M 14 x 2,00	12,00	D 110 x 26 x 11,0 x 9,0	72,61	79,79
M 16 x 2,00	14,00	D 110 x 27 x 12,0 x 9,0	81,36	88,06
M 18 x 2,50	15,50	D 125 x 30 x 14,0 x 11,0	127,14	130,38
M 20 x 2,50	17,50	D 140 x 32 x 16,0 x 12,0	129,51	134,36

MACHOS DE MÁQUINA PARA TRABAJOS ESPECIALES HSSCo

AI
FUNDICIÓN
LATÓN
DIN 13 60°
HSSCo 5%
MD
TOL 6H

Vc
18 m/min

Vc
11 m/min

Vc
21 m/min

Vc
16 m/min

Vc
19 m/min

Vc
19 m/min

D
MANGO DELGADO

DIN
376

R
MANGO REFORZADO

DIN
371

		M5R	M6R	M1RFM	MHM1R	M1RL	M1RLCRN	
APLICACIÓN		AI	AI	FUNDICIÓN	FUNDICIÓN	LATÓN	LATÓN	
MATERIAL		HSSCo 5%	HSSCo 5%	HSSCo 5%	MD	HSSCo 5%	HSSCo 5%	
ACABADO		BRILLANTE	BRILLANTE	OX	BRILLANTE	BRILLANTE	CrN	
FORMA		DIENTE ALTERNO	2 CANALES	FORMA C	FORMA C	FORMA C	FORMA C	
		L1 x L2 x D2 x ∇ mm		€	€	€	€	
M 3x0,50	2,50	R 56 x 11 x 3,5 x 2,7	23,91	25,65	16,92	85,74	20,25	23,01
M 4x0,70	3,30	R 63 x 13 x 4,5 x 3,4	24,05	25,65	17,48	85,74	21,50	25,36
M 5x0,80	4,20	R 70 x 16 x 6,0 x 4,9	23,91	26,20	17,48	85,74	21,50	25,45
M 6x1,00	5,00	R 80 x 17 x 6,0 x 4,9	25,20	28,33	19,86	97,80	23,56	27,79
M 8x1,25	6,80	R 90 x 20 x 8,0 x 6,2	30,17	33,95	22,24	109,20	26,87	33,79
M 10x1,50	8,50	R 100 x 22 x 10,0 x 8,0	36,37	40,14	25,44	136,86	32,32	41,12
MANGO DELGADO		M5D	M6D	M1DFM	MHM1D	M1DL	M1DLCRN	
M 12x1,75	10,20	D 110 x 24 x 9,0 x 7,0	46,23	50,45	32,60	190,92	38,42	50,63
M 14x2,00	12,00	D 110 x 26 x 11,0 x 9,0	83,72	87,13	53,59	297,42	47,17	61,70
M 16x2,00	14,00	D 110 x 27 x 12,0 x 9,0	91,25	98,81	63,05	353,84	54,26	68,99
M 18x2,50	15,50	D 125 x 30 x 14,0 x 11,0			88,20	433,74	71,17	87,37
M 20x2,50	17,50	D 140 x 32 x 16,0 x 12,0			88,55	525,24	79,88	97,27



- Lubricación: **CUT MAGIC ALUMINIO**
- Se recomienda la aplicación del Aceite de corte CUT MAGIC ALUMINIO para optimizar el proceso de roscado en Aluminio y sus fundiciones.

MACHOS DE MÁQUINA PARA ROSCADO POR LAMINACIÓN

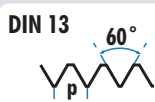
LAMINACIÓN

DIN 13
60°
HSSCo
5%
HSSCo
8%
TOL
6HX
APLICACIONES

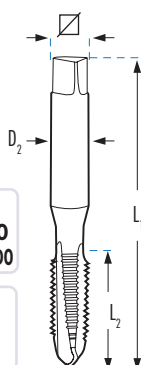
800
N/mm²
Al
FUNDICIÓN

1400
N/mm²
INOX
Plus
R
MANGO
REFORZADO
DIN
2174

				M07R	M07RT	M07RCR	M07RCCR	M09RCCR	M07RXTCR
		APLICACIÓN		LAMINACION	LAMINACION	LAMINACION	LAMINACION	LAMINACION	LAMINACION
		MATERIAL		HSSCo 5%	HSSCo 5%	HSSCo 5%	HSSCo 5%	HSSCo 8%	HSSCo 5%
		ACABADO		OX	TiN	OX	TiCN	TiCN	TiN
		FORMA							
			L1 x L2 x D2 x ∇ mm	€	€	€	€	€	€
M	3x0,50	2,75	R 56 x 11 x 3,5 x 2,7	33,82	36,72	37,22	46,70	112,36	83,79
M	3,5x0,60	3,20	R 56 x 11 x 3,5 x 2,7	35,55	40,49	38,45	49,43		
M	4x0,70	3,65	R 63 x 13 x 4,5 x 3,4	33,82	38,29	37,22	48,71	113,78	83,79
M	5x0,80	4,60	R 70 x 16 x 6,0 x 4,9	33,82	38,29	37,22	48,71	115,29	90,43
M	6x1,00	5,50	R 80 x 17 x 6,0 x 4,9	36,52	40,47	40,16	51,48	117,12	90,43
M	8x1,25	7,40	R 90 x 20 x 8,0 x 6,2	42,56	53,41	46,82	67,97	129,92	108,22
M	10x1,50	9,30	R 100 x 22 x 10,0 x 8,0	47,33	59,89	52,08	74,80	155,12	132,12
MANGO DELGADO				M07D	M07DT	M07DCR	M07DCCR	M09DCCR	M07DXTCR
M	12x1,75	11,20	D 110 x 24 x 9,0 x 7,0	55,79	78,32	59,09	85,66	183,62	172,05
M	14x2,00	13,05	D 110 x 26 x 11,0 x 9,0	100,57	123,69	104,48	139,06	228,52	247,51
M	16x2,00	15,05	D 110 x 27 x 12,0 x 9,0	118,06	139,31	122,63	147,21	314,30	251,80
M	18x2,50	16,80	D 125 x 30 x 14,0 x 11,0	135,48	166,58	140,72	173,94	372,40	
M	20x2,50	18,80	D 140 x 32 x 16,0 x 12,0	178,51	252,17	185,43	264,43	412,29	

MACHOS DE MÁQUINA HSSCo TOLERANCIAS ESPECIALES Y SOBREMEDIDAS



				M2R4H	M4R4H	M2R6G	M4R6G	M2R7G	M4R7G	M2R+0,1	M4R+0,1	M2R+0,2	M4R+0,2	
				TOL 4H	TOL 4H	TOL 6G	TOL 6G	TOL 7G	TOL 7G	TOL 6H (+0,1)	TOL 6H (+0,1)	TOL 6H (+0,2)	TOL 6H (+0,2)	
				HSSCo 5%	HSSCo 5%	HSSCo 5%	HSSCo 5%	HSSCo 5%	HSSCo 5%	HSSCo 5%	HSSCo 5%	HSSCo 5%	HSSCo 5%	
				BRILLANTE	BRILLANTE	BRILLANTE	BRILLANTE	BRILLANTE	BRILLANTE	BRILLANTE	BRILLANTE	BRILLANTE	BRILLANTE	
				FORMA B	FORMA B 35°	FORMA B	FORMA B 35°	FORMA B	FORMA B 35°	FORMA B	FORMA B 35°	FORMA B	FORMA B 35°	
				€	€	€	€	€	€	€	€	€	€	
M	3x0,50	2,50	R	56 x 11 x 3,5 x 2,7	23,14	28,61	16,98	20,20	23,14	28,61	23,89	31,87	27,41	33,94
M	4x0,70	3,30	R	63 x 13 x 4,5 x 3,4	23,68	28,61	16,98	20,20	23,68	28,61	24,45	31,87	28,04	33,94
M	5x0,80	4,20	R	70 x 16 x 6,0 x 4,9	23,68	27,42	16,98	19,82	23,68	27,42	24,45	30,52	28,04	32,49
M	6x1,00	5,00	R	80 x 17 x 6,0 x 4,9	26,02	30,08	18,28	21,77	26,02	30,08	26,85	33,50	30,82	35,66
M	8x1,00	7,00	D	90 x 20 x 6,0 x 4,9			35,60	39,36						
M	8x1,25	6,75	R	90 x 20 x 8,0 x 6,2	29,14	34,35	21,25	25,52	29,14	34,35	30,08	38,22	34,52	40,71
M	10x1,00	9,00	D	90 x 16 x 7,0 x 5,5			42,04	48,93						
M	10x1,50	8,50	R	100 x 22 x 10,0 x 8,0	35,83	40,77	26,15	29,18	35,83	40,77	37,01	45,33	42,48	48,26
		MANGO DELGADO		M2D4H	M4D4H	M2D6G	M4D6G	M2D7G	M4D7G	M2D+0,1	M4D+0,1	M2D+0,2	M4D+0,2	
M	12x1,50	10,50	D	100 x 22 x 9,0 x 7,0			76,60	90,81						
M	12x1,75	10,20	D	110 x 24 x 9,0 x 7,0	46,20	54,85	34,48	41,54	46,20	54,85	46,35	58,76	52,66	62,57
M	14x2,00	12,00	D	110 x 26 x 11,0 x 9,0			42,36	50,89			75,61	93,53	85,92	99,61
M	16x2,00	14,00	D	110 x 27 x 12,0 x 9,0			52,35	61,47			88,92	113,03	101,08	120,37
M	18x2,50	15,50	D	125 x 30 x 14,0 x 11,0			73,83	76,10			134,46	152,24	143,18	162,11
M	20x2,50	17,50	D	140 x 32 x 16,0 x 12,0			76,25	87,48			145,29	161,99	154,71	172,50

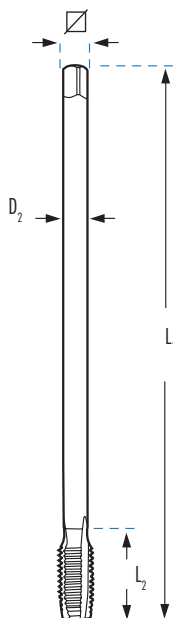

4H.- Para roscas muy precisas. Ajuste más exacto.
 6G.- Para roscas con recubrimientos. Espesores entre 20 - 40 μ
 7G.- Para roscas con recubrimientos. Espesores entre 40 - 50 μ
 6H. (+0,1)- Hay que añadir 0,10mm a la broca previa.
 6H. (+0,2)- Hay que añadir 0,20mm a la broca previa.

MACHOS DE MÁQUINA EXTRALARGOS HSSCo

FORMA
BHSSCo
5%

BRILLANTE

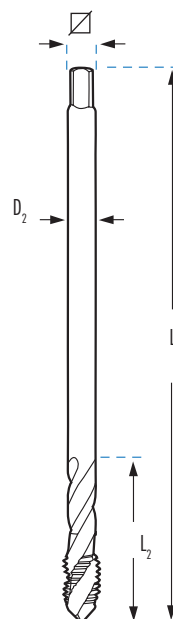

TOL
6HR
MANGO
REFORZADODIN
371D
MANGO
DELGADODIN
376

				M2L
			L1 x L2 x D2 x 	FORMA B
			mm	€
M2LM03X0,50	M 3x0,50	2,50	R 100 x 10 x 3,5 x 2,7	38,63
M2LM04X0,70	M 4x0,70	3,30	R 120 x 12 x 4,5 x 3,4	39,48
M2LM05X0,80	M 5x0,80	4,20	R 140 x 14 x 6,0 x 4,9	39,48
M2LM06X1,00-120	M 6x1,00	5,00	R 120 x 16 x 6,0 x 4,9	41,67
M2LM06X1,00	M 6x1,00	5,00	R 160 x 16 x 6,0 x 4,9	43,38
M2LM07X1,00	M 7x1,00	6,00	R 160 x 17 x 7,0 x 5,5	49,27
M2LM08X1,25-150	M 8x1,25	6,80	R 150 x 18 x 8,0 x 6,2	49,34
M2LM08X1,25	M 8x1,25	6,80	R 180 x 18 x 8,0 x 6,2	50,86
				M2L-D
				MANGO DELGADO
M2LM06X1,00D	M 6x1,00	5,00	D 160 x 16 x 4,5 x 3,4	45,03
M2LM08X1,25D	M 8x1,25	6,80	D 180 x 18 x 6,2 x 5,0	52,84
M2LM10X1,50-150	M 10x1,50	8,50	D 150 x 20 x 7,0 x 5,5	58,13
M2LM10X1,50	M 10x1,50	8,50	D 200 x 20 x 7,0 x 5,5	62,61
M2LM12X1,75-150	M 12x1,75	10,20	D 150 x 22 x 8,5 x 6,5	72,11
M2LM12X1,75	M 12x1,75	10,20	D 220 x 22 x 8,5 x 6,5	77,04
M2LM14X2,00	M 14x2,00	12,00	D 220 x 25 x 10,5 x 8,0	119,55
M2LM16X2,00	M 16x2,00	14,00	D 220 x 28 x 12,5 x 10,0	140,64
M2LM18X2,50	M 18x2,50	15,50	D 250 x 32 x 14,0 x 11,0	255,90
M2LM20X2,50	M 20x2,50	17,50	D 250 x 32 x 16,0 x 12,0	276,57
M2LM22X2,50	M 22x2,50	19,50	D 250 x 35 x 18,0 x 14,5	315,32
M2LM24X3,00	M 24x3,00	21,00	D 250 x 38 x 18,0 x 14,5	385,57

HSSCo
5%

BRILLANTE

TOL
6HR
MANGO
REFORZADODIN
371D
MANGO
DELGADODIN
376

				M4L
			L1 x L2 x D2 x 	FORMA B
			mm	€
M4LM03X0,50	M 3x0,50	2,50	R 100 x 10 x 3,5 x 2,7	47,80
M4LM04X0,70	M 4x0,70	3,30	R 120 x 12 x 4,5 x 3,4	47,80
M4LM05X0,80	M 5x0,80	4,20	R 140 x 14 x 6,0 x 4,9	45,79
M4LM06X1,00-120	M 6x1,00	5,00	R 120 x 16 x 6,0 x 4,9	47,21
M4LM06X1,00	M 6x1,00	5,00	R 160 x 16 x 6,0 x 4,9	50,23
M4LM07X1,00	M 7x1,00	6,00	R 160 x 17 x 7,0 x 5,5	57,03
M4LM08X1,25-150	M 8x1,25	6,80	R 150 x 18 x 8,0 x 6,2	57,86
M4LM08X1,25	M 8x1,25	6,80	R 180 x 18 x 8,0 x 6,2	61,04
				M4L-D
				MANGO DELGADO
M4LM06X1,00D	M 6x1,00	5,00	D 160 x 16 x 4,5 x 3,4	52,19
M4LM08X1,25D	M 8x1,25	6,80	D 180 x 18 x 6,2 x 5,0	62,15
M4LM10X1,50-150	M 10x1,50	8,50	D 150 x 20 x 7,0 x 5,5	65,48
M4LM10X1,50	M 10x1,50	8,50	D 200 x 20 x 7,0 x 5,5	70,74
M4LM12X1,75-150	M 12x1,75	10,20	D 150 x 22 x 8,5 x 6,5	80,18
M4LM12X1,75	M 12x1,75	10,20	D 220 x 22 x 8,5 x 6,5	91,51
M4LM14X2,00	M 14x2,00	12,00	D 220 x 25 x 10,5 x 8,0	133,96
M4LM16X2,00	M 16x2,00	14,00	D 220 x 28 x 12,5 x 10,0	194,13
M4LM18X2,50	M 18x2,50	15,50	D 250 x 32 x 14,0 x 11,0	289,75
M4LM20X2,50	M 20x2,50	17,50	D 250 x 32 x 16,0 x 12,0	308,37
M4LM22X2,50	M 22x2,50	19,50	D 250 x 35 x 18,0 x 14,5	345,44
M4LM24X3,00	M 24x3,00	21,00	D 250 x 38 x 18,0 x 14,5	393,79

MACHO TUERQUERO DE ROSCA MÉTRICA DIN 357



HSSCo
5%

BRILLANTE

TOL
6H

DIN
357

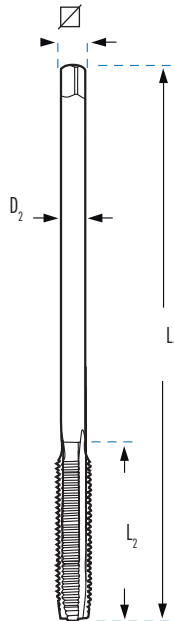

				MTU	
				FORMA A	
				€	
			L1 x L2 x D2 x ∇ mm		
M	3x0,50**	2,50	D 70 x 22 x 2,2	25,34	
M	4x0,70	3,30	D 90 x 25 x 2,8 x 2,1	25,34	
M	5x0,80	4,20	D 100 x 28 x 3,5 x 2,7	25,34	
M	6x1,00	5,00	D 110 x 32 x 4,5 x 3,4	25,34	
M	8x1,25	6,80	D 125 x 40 x 6,0 x 4,9	30,54	
M	10x1,50	8,50	D 140 x 45 x 7,0 x 5,5	29,85	
M	12x1,75	10,20	D 180 x 50 x 9,0 x 7,0	36,15	
M	14x2,00	12,00	D 200 x 56 x 11,0 x 9,0	57,13	
M	16x2,00	14,00	D 200 x 63 x 12,0 x 9,0	70,73	
M	18x2,50	15,50	D 220 x 63 x 14,0 x 11,0	95,15	
M	20x2,50	17,50	D 250 x 70 x 16,0 x 12,0	134,33*	
M	22x2,50	19,50	D 280 x 80 x 18,0 x 14,5	164,81*	
M	24x3,00	21,00	D 280 x 80 x 18,0 x 14,5	224,25*	

** Mango cilíndrico

*Hasta fin de existencias

MACHO DE MÁQUINA ROSCA TRAPEZOIDAL HSS

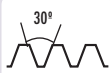

HSS

BRILLANTE



DIN
103

TOL
7H

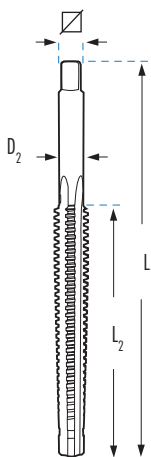

				MRTM	
				€	
			L1 x L2 x D2 x ∇ mm		
Tr	14 x 3	11,25	160 x 105 x 10,5 x 8,0	598,95	
Tr	16 x 4	12,25	205 x 110 x 11,5 x 9,0	623,53	
Tr	18 x 4	14,25	215 x 120 x 13,0 x 10,0	657,30	
Tr	20 x 4	16,25	230 x 130 x 15,0 x 12,0	660,38	
Tr	22 x 5	17,25	270 x 165 x 16,0 x 12,0	869,25	
Tr	24 x 5	19,25	280 x 165 x 18,0 x 14,5	985,98	
Tr	26 x 5	21,25	290 x 170 x 20,0 x 16,0	1.020,18	
Tr	28 x 5	23,25	300 x 180 x 22,0 x 18,0	1.155,64	
Tr	30 x 6	24,25	345 x 200 x 23,0 x 18,0	1.329,98	

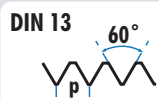
BROCA MACHO HSSCo

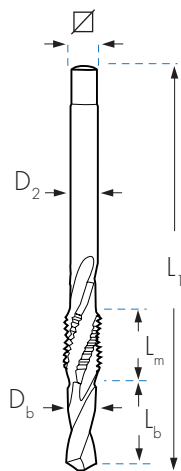
HSSCo
 5%

BRILLANTE
TOL
6H
R
MANGO
REFORZADO
DIN
371
D
MANGO
DELGADO
DIN
376

		M8M							
		Lb mm	Lm mm	L1 mm	Db mm	D2 mm	∇ mm	€	
M	3x0,50	R	9,0	12,5	62,0	2,5	3,5	2,7	38,84
M	4x0,70	R	10,0	16,0	66,0	3,30	4,5	3,4	38,84
M	5x0,80	R	12,5	18,0	75,5	4,20	6,0	4,9	40,36
M	6x1,00	R	14,0	20,0	81,0	5,00	6,0	4,9	44,57
M	8x1,00	R	20,0	14,0	91,0	7,00	6,0	4,9	52,32
M	8x1,25	R	20,0	14,0	91,0	6,75	8,0	6,2	50,25

MANGO DELGADO

M	8x1,25	D	20,0	14,0	91,0	6,75	6,0	4,9	54,29
M	10x1,00	D	20,0	15,0	95,0	9,00	7,0	5,5	64,94
M	10x1,50	D	25,0	18,0	105,0	8,50	7,0	5,5	68,93
M	12x1,50	D	24,0	18,0	110,0	10,50	9,0	7,0	75,23
M	12x1,75	D	28,0	20,0	118,0	12,50	11,0	9,0	74,79
M	14x1,50	D	28,0	20,0	118,0	12,50	11,0	9,0	119,05
M	14x2,00	D	28,0	22,0	130,0	12,00	11,0	9,0	135,41
M	16x2,00	D	36,0	24,0	139,0	14,00	12,0	9,0	178,09
M	18x2,50	D	40,0	26,0	151,0	15,50	14,0	11,0	259,75
M	20x2,50	D	45,0	30,0	168,0	17,50	16,0	2,0	373,02

Nota: Jamás emplee los Broca-Machos en agujeros ciegos o en pasantes más profundos que Lb

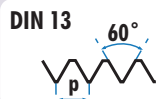
BROCA MACHO AVELLANADOR HSSCo STEP CUT
NEW

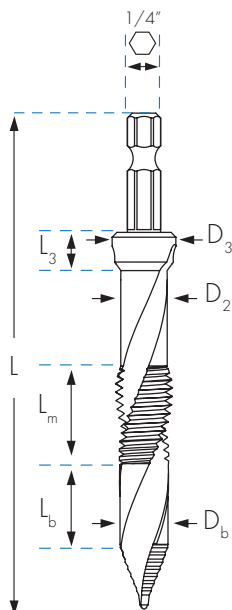
HSSCo
 5%

BRILLANTE
TOL
6H
D
MANGO
DELGADO
1/4"
STEP CUT

		MTKM									
		Lb mm	Lm mm	L3 mm	L mm	Db mm	D2 mm	D3 mm		€	
M	3x0,50	D	7,0	6,0	6,0	57,0	2,5	2,2	7,3	1/4"	28,21
M	4x0,70	D	7,0	8,5	6,0	62,0	3,3	3,0	7,3	1/4"	28,21
M	5x0,80	D	9,0	10,0	6,0	69,0	4,2	3,7	7,3	1/4"	29,44
M	6x1,00	D	10,0	12,0	6,0	73,0	5,0	4,5	7,3	1/4"	30,66
M	8x1,25	D	12,0	16,0	6,0	87,0	6,8	6,3	9,4	1/4"	42,38
M	10x1,50	D	14,0	20,0	6,0	96,0	8,5	8,0	11,4	1/4"	51,14
M	12x1,75	D	16,0	24,0	8,0	112,0	10,3	9,8	13,4	1/4"	56,36

Nota: Jamás emplee los Broca Macho Avellanador en agujeros ciegos o en pasantes más profundos que Lb

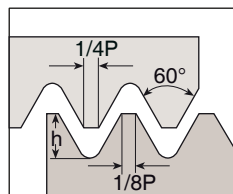
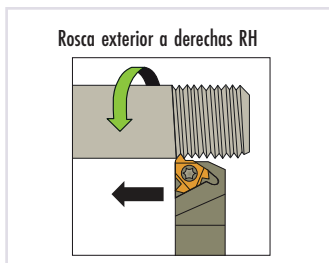
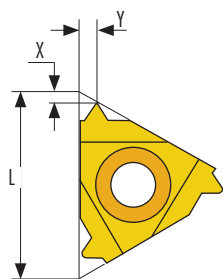
PLAQUITAS PARA ROSCADO DE EXTERIORES



Norma: R262 (DIN 13)
Tolerancia clase: 6g/6H

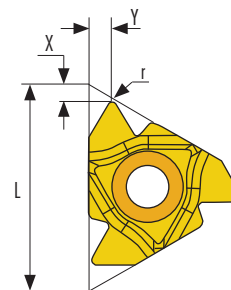

Perfil Total

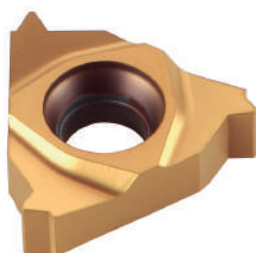
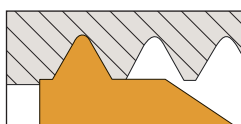

Perfil Parcial

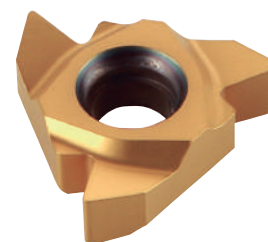
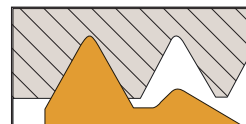

Rosca el perfil completo, terminando el diámetro exterior de la rosca.
Utilizaremos una plaquita diferente para cada paso.

No termina el diámetro exterior de la rosca.
La misma plaquita puede ser utilizada para una gama de diferentes pasos, que tengan el mismo ángulo de rosca.

PERFIL TOTAL 60°

ROSCADO EXTERIOR	L	PASO	h	X	Y	€
PRE-16-075		0,75	0,46	0,6	0,6	26,84*
PRE-16-100		1,00	0,61	0,7	0,7	26,84*
PRE-16-125		1,25	0,77	0,8	0,9	26,84*
PRE-16-150	16	1,50	0,92	0,8	1	26,84*
PRE-16-175		1,75	1,07	0,9	1,2	26,84*
PRE-16-200		2,00	1,23	1	1,3	26,84*
PRE-16-250		2,50	1,53	1,1	1,5	26,84*
PRE-16-300		3,00	1,84	1,2	1,6	26,84*

*Hasta fin de existencias

PERFIL PARCIAL 60°

ROSCADO EXTERIOR	L	RANGOS MÉTRICOS	RANGO PULGADAS	r	X	Y	€
PPRE-16-150	16	0,50-1,50	48 - 16	0,05	0,80	0,90	26,84*

*Hasta fin de existencias

PORTAHERRAMIENTAS DE ROSCADO DE EXTERIORES

ROSCADO EXTERIOR	H1=H=B=F	L1	L2	€
PEXT-25-16	25	153	30	196,21*

*Hasta fin de existencias

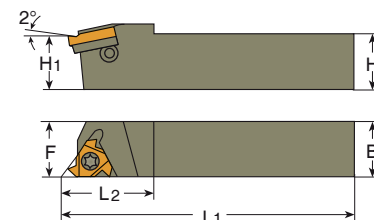

FÓRMULA MATEMÁTICA PARA OBTENER LA VELOCIDAD DE GIRO DE LA PIEZA (RPM)

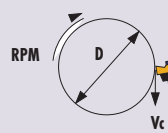

$$RPM = \frac{1000 \times Vc}{\pi \times D}$$

RPM: Revoluciones x minuto
Vc: Velocidad de Corte (m/min)
D: Diámetro Pieza (mm)
Las RPM-s se Obtienen en función de Vc y D

	Vc		Vc
ACERO BLANDO 70 kg/mm ²	25 m / min	ALUMINIO	50 m / min
ACERO TRATADO 120 kg/mm ²	13 m / min	TITANIO	18 m / min
INOXIDABLE	11 m / min	FUNDICIÓN	25 m / min
		LATÓN	50 m / min

PLAQUITAS PARA ROSCADO DE INTERIORES

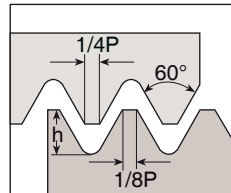
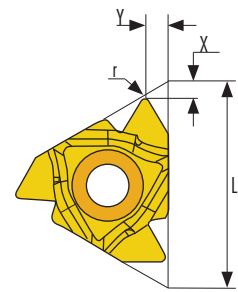
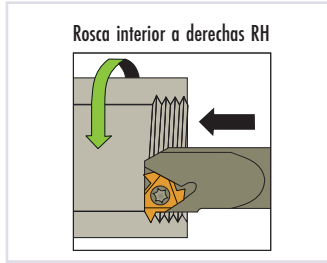
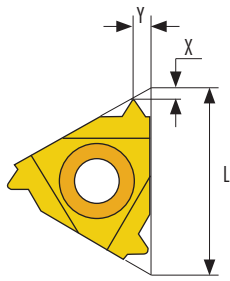

Norma: R262 (DIN 13)
Tolerancia clase: 6g/6H

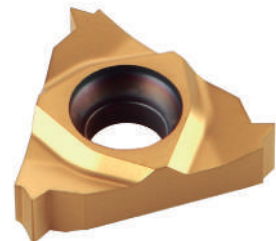
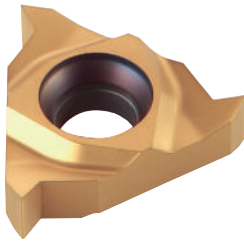

PERFIL TOTAL 60°

ROSCADO INTERIOR	L	PASO	h	X	Y	€
PRI-16-075	16	0,75	0,43	0,6	0,6	26,84*
PRI-16-100		1,00	0,58	0,6	0,7	26,84*
PRI-16-125		1,25	0,72	0,8	0,9	26,84*
PRI-16-150		1,50	0,87	0,8	1,0	26,84*
PRI-16-175		1,75	1,01	0,9	1,2	26,84*
PRI-16-200		2,00	1,15	1,0	1,3	26,84*
PRI-16-250		2,50	1,44	1,1	1,5	26,84*
PRI-16-300		3,00	1,73	1,1	1,5	26,84*

*Hasta fin de existencias

PERFIL PARCIAL 60°

ROSCADO INTERIOR	L	RANGOS MÉTRICOS	RANGO PULGADAS	r	X	Y	€
PPRI-16-150	16	0,50-1,50	48 - 16	0,05	0,80	0,90	26,84*
PPRI-16-300		1,75-3,00	14 - 8	0,16	1,20	1,70	26,84*

*Hasta fin de existencias

PORTAHERRAMIENTAS DE ROSCADO DE INTERIORES

ROSCADO INTERIOR	L	L1	D	D1	A	Ø MÍN. AGUJERO	€
PINT-25-16	200	45	25	24,6	22,6	29	236,46*

*Hasta fin de existencias

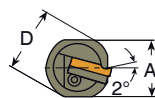
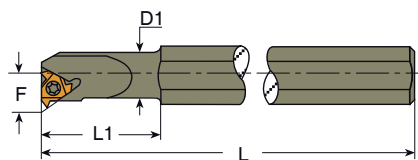

MACHOS DE MÁQUINA HSSCo EN ESTUCHES METÁLICOS

**USO
GENERAL**

**HSSCo
5%**



Ref. JM6



Ref. JM2





Ref. JM8



Ref. JM4



CONTENIDO

	FORMA C	FORMA B	 15°	 35°	 HSS	HSSCo 5% €
JM5	M3 - M4 - M5 - M6 M8 - M10 - M12	-	-	-	-	111,81
JM1	M3 - M4 - M5 - M6 M8 - M10 - M12	-	-	-	2.5/3.3/4.2/5.0/6.8/8.5/10.2 mm	133,74
JM6	-	M3 - M4 - M5 - M6 M8 - M10 - M12	-	-	-	119,13
JM2	-	M3 - M4 - M5 - M6 M8 - M10 - M12	-	-	2.5/3.3/4.2/5.0/6.8/8.5/10.2 mm	133,98
JM7	-	-	M3 - M4 - M5 - M6 M8 - M10 - M12	-	-	148,42
JM3	-	-	M3 - M4 - M5 - M6 M8 - M10 - M12	-	2.5/3.3/4.2/5.0/6.8/8.5/10.2 mm	177,35
JM8	-	-	-	M3 - M4 - M5 - M6 M8 - M10 - M12	-	150,98
JM4	-	-	-	M3 - M4 - M5 - M6 M8 - M10 - M12	2.5/3.3/4.2/5.0/6.8/8.5/10.2 mm	175,46



MACHOS DE MÁQUINA EN ESTUCHES METÁLICOS
Plus

Ref. JMPT2



CONTENIDO

	FORMA B	BRILLANTE	 35°	BRILLANTE	 HSSCo 5%	HSS PM €		TiN €
JMP6	M3 - M4 - M5 - M6 M8 - M10 - M12		-		-	124,14	JMPT6	179,05
JMP2	M3 - M4 - M5 - M6 M8 - M10 - M12		-		2.5/3.3/4.2/5.0/6.8/8.5/10.2 mm	162,80	JMPT2	217,85
JMP8	-		M3 - M4 - M5 - M6 M8 - M10 - M12		-	179,05	JMPT8	197,20
JMP4	-		M3 - M4 - M5 - M6 M8 - M10 - M12		2.5/3.3/4.2/5.0/6.8/8.5/10.2 mm	217,85	JMPT4	236,13

INOX
CONTENIDO

	FORMA B	OX	 35°	OX	 HSSCo 5%	HSS PM €		TiN €
JMX6	M3 - M4 - M5 - M6 M8 - M10 - M12		-		-	160,16	JMXT6	174,71
JMX2	M3 - M4 - M5 - M6 M8 - M10 - M12		-		2.5/3.3/4.2/5.0/6.8/8.5/10.2 mm	198,98	JMXT2	213,53
JMX8	-		M3 - M4 - M5 - M6 M8 - M10 - M12		-	182,77	JMXT8	201,50
JMX4	-		M3 - M4 - M5 - M6 M8 - M10 - M12		2.5/3.3/4.2/5.0/6.8/8.5/10.2 mm	221,57	JMXT4	240,29

1200
 N/mm²
CONTENIDO

	FORMA B	OX	 35°	OX	 HSSCo 5%	HSS V3 €		TINALOX €
JMMD6	M3 - M4 - M5 - M6 M8 - M10 - M12		-		-	145,58	JMMDT6	206,68
JMMD2	M3 - M4 - M5 - M6 M8 - M10 - M12		-		2.5/3.3/4.2/5.0/6.8/8.5/10.2 mm	184,39	JMMDT2	245,48
JMMD8	-		M3 - M4 - M5 - M6 M8 - M10 - M12		-	166,15	JMMDT8	238,33
JMMD4	-		M3 - M4 - M5 - M6 M8 - M10 - M12		2.5/3.3/4.2/5.0/6.8/8.5/10.2 mm	204,95	JMMDT4	277,13

MACHOS DE MÁQUINA EN ESTUCHES METÁLICOS

1400
N/mm²



Ref. JMC2

CONTENIDO

	FORMA B	TiCN	15° TiCN	HSSCo 5%	HSS-PM €
JMC6	M3 - M4 - M5 - M6 - M8 - M10 - M12	-	-	-	247,65
JMC2	M3 - M4 - M5 - M6 - M8 - M10 - M12	-	-	2.5/3.3/4.2/5.0/6.8/8.5/10.2 mm	286,46
JMC8	-	M3 - M4 - M5 - M6 - M8 - M10 - M12	-	-	281,89
JMC4	-	M3 - M4 - M5 - M6 - M8 - M10 - M12	2.5/3.3/4.2/5.0/6.8/8.5/10.2 mm	-	320,70

**TODO
TERRENO**

CONTENIDO

	FORMA B	TiN	35° TiN	HSSCo 5%	HSSCo 5% €
JMD6	M3 - M4 - M5 - M6 - M8 - M10 - M12	-	-	-	223,80
JMD2	M3 - M4 - M5 - M6 - M8 - M10 - M12	-	-	2.5/3.3/4.2/5.0/6.8/8.5/10.2 mm	262,61
JMD8	-	M3 - M4 - M5 - M6 - M8 - M10 - M12	-	-	252,38
JMD4	-	M3 - M4 - M5 - M6 - M8 - M10 - M12	2.5/3.3/4.2/5.0/6.8/8.5/10.2 mm	-	291,19

AI

CONTENIDO

	DIENTE ALTERNO	BRILLANTE	2 CANALES BRILLANTE	HSS	HSSCo 5% €
JMAL6	M3 - M4 - M5 - M6 - M8 - M10 - M12	-	-	-	177,20
JMAL2	M3 - M4 - M5 - M6 - M8 - M10 - M12	-	-	2.5/3.3/4.2/5.0/6.8/8.5/10.2 mm	216,00
JMAL8	-	M3 - M4 - M5 - M6 - M8 - M10 - M12	-	-	175,22
JMAL4	-	M3 - M4 - M5 - M6 - M8 - M10 - M12	2.5/3.3/4.2/5.0/6.8/8.5/10.2 mm	-	214,03

MACHOS DE MÁQUINA EN ESTUCHES
**USO
GENERAL**
CONTENIDO

	FORMA B	BRILLANTE	 35°	BRILLANTE	HSSCo 5% €
PT01	M4 - M5 - M6 - M8 - M10	M4 - M5 - M6 - M8 - M10	M4 - M5 - M6 - M8 - M10	M4 - M5 - M6 - M8 - M10	135,91



Ref. PT01

Plus
CONTENIDO

	FORMA B	BRILLANTE	 35°	BRILLANTE	HSS PM €	TiN €
PT02	M4 - M5 - M6 - M8 - M10	M4 - M5 - M6 - M8 - M10	M4 - M5 - M6 - M8 - M10	M4 - M5 - M6 - M8 - M10	170,97	PT03 251,09



Ref. PT03

INOX
CONTENIDO

	FORMA B	OX	 35°	OX	HSS PM €	TiN €
PT05	M4 - M5 - M6 - M8 - M10	M4 - M5 - M6 - M8 - M10	M4 - M5 - M6 - M8 - M10	M4 - M5 - M6 - M8 - M10	224,65	PT13 239,07

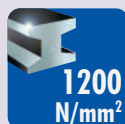

Ref. PT05

CONTENIDO

	FORMA B	OX	 35°	OX	HSS V3 €	TINALOX €
PT04	M4 - M5 - M6 - M8 - M10	M4 - M5 - M6 - M8 - M10	M4 - M5 - M6 - M8 - M10	M4 - M5 - M6 - M8 - M10	192,79	PT14 289,73



Ref. PT04

CONTENIDO

	FORMA B	TiCN	 15°	TiCN	HSS PM €
PT11	M4 - M5 - M6 - M8 - M10	M4 - M5 - M6 - M8 - M10	M4 - M5 - M6 - M8 - M10	M4 - M5 - M6 - M8 - M10	349,27



Ref. PT11

MACHOS DE MÁQUINA EN ESTUCHES



Ref. PT06

CONTENIDO

	DIENTE ALTERNO	2 CANALES	HSSCo 5% €
PT06	M4 - M5 - M6 M8 - M10	M4 - M5 - M6 M8 - M10	213,14



Ref. PT07

CONTENIDO

	FORMA C	HSSCo 5% €
PT07	M4 - M5 - M6 - M8 - M10 M4 - M5 - M6 - M8 - M10	161,08



Ref. PT10

CONTENIDO

	FORMA C	HSSCo 5% €
PT10	M4 - M5 - M6 - M8 - M10 M4 - M5 - M6 - M8 - M10	195,81



Ref. PT08

CONTENIDO

		HSSCo 5% €
PT08	M4 - M5 - M6 - M8 - M10 M4 - M5 - M6 - M8 - M10	294,81



Ref. PT09

CONTENIDO

		HSSCo 5% €
PT09	M4 - M5 - M6 - M8 - M10 M4 - M5 - M6 - M8 - M10	397,16



Ref. PT12

CONTENIDO

	FORMA B	 35°	HSSCo 5% €
PT12	M4 - M5 - M6 M8 - M10	M4 - M5 - M6 M8 - M10	220,24

EXPOSITORES DE METACRILATO PARA MACHOS DE MÁQUINA
EXPOSITOR DE METACRILATO

MM-03

Composición: Machos de máquina, Serie Normal

HSSCo
5%

Ref. MM-03

FORMA

B

Agujeros pasantes, Ref. M2

M4	M5	M6	M8	M10	M12	M14
5	10	10	10	10	5	4

Agujeros ciegos, Ref. M4

M4	M5	M6	M8	M10	M12	M14
5	10	10	10	10	5	4



35°

Dimensiones: ancho 240 x fondo 240 x alto 245 mm

2.091,99 €



Ref. MM-04

EXPOSITOR DE METACRILATO

MM-04

Composición: Machos de máquina, Serie Plus
Fabricados en Acero sinterizado PM
HSS
PM
Plus
FORMA

B

Agujeros pasantes, Ref. M2

M4	M5	M6	M8	M10	M12	M14
5	10	10	10	10	5	4

Agujeros ciegos, Ref. M4

M4	M5	M6	M8	M10	M12	M14
5	10	10	10	10	5	4



35°

Dimensiones: ancho 240 x fondo 240 x alto 245 mm

2.854,15 €

EXPOSITOR DE METACRILATO

MM-05

Composición: Machos de máquina para trabajos especiales

FORMA

B

Agujeros pasantes, Ref. M2



35°

Agujeros ciegos, Ref. M4

1200
N/mm²

M4	M5	M6	M8	M10	M12	M14
1	2	2	2	2	1	1

1200
N/mm²

M4	M5	M6	M8	M10	M12	M14
1	2	2	2	2	1	1



INOX

M4	M5	M6	M8	M10	M12	M14
1	2	2	2	2	1	1



INOX

M4	M5	M6	M8	M10	M12	M14
1	2	2	2	2	1	1



AI

M4	M5	M6	M8	M10	M12	M14
1	2	2	2	2	1	1



AI

M4	M5	M6	M8	M10	M12	M14
1	2	2	2	2	1	1



TiN

M4	M5	M6	M8	M10	M12	M14
1	2	2	2	2	1	1



TiN

M4	M5	M6	M8	M10	M12	M14
1	2	2	2	2	1	1

1400
N/mm²

M4	M5	M6	M8	M10	M12
1	2	2	2	2	1

1400
N/mm²

M4	M5	M6	M8	M10	M12
1	2	2	2	2	1

Dimensiones: ancho 240 x fondo 240 x alto 245 mm

3.565,05 €