

BLUE-MASTER[®]
by *celesa*



BITS PARA
PARAFUSOS

BITS INTERCAMBIÁVEIS
Plus

25mm
 COMPR.
 TOTAL
 (L.)

PHILLIPS

| € x Bit | L1 mm | 2 Uds | | 5 Uds | | 50 Uds | | 100 Uds | |
|---------|----------|-------|-------------|-------|-------------|--------|-------------|---------|-------------|
| | | | € | | € | | € | | € |
| Ph 0 | 25 | Ph0-2 | 1,55 | Ph0-5 | 1,36 | Ph0-50 | 1,21 | Ph0-100 | 1,16 |
| Ph 1 | 25 | Ph1-2 | 1,30 | Ph1-5 | 0,81 | Ph1-50 | 0,73 | Ph1-100 | 0,68 |
| Ph 2 | 25 | Ph2-2 | 1,30 | Ph2-5 | 0,81 | Ph2-50 | 0,73 | Ph2-100 | 0,68 |
| Ph 3 | 25 | Ph3-2 | 1,30 | Ph3-5 | 0,81 | Ph3-50 | 0,73 | Ph3-100 | 0,68 |

POZIDRIV

| € x Bit | L1 mm | 2 Uds | | 5 Uds | | 50 Uds | | 100 Uds | |
|---------|----------|-------|-------------|-------|-------------|--------|-------------|---------|-------------|
| | | | € | | € | | € | | € |
| Pz 0 | 25 | Pz0-2 | 1,55 | Pz0-5 | 1,36 | Pz0-50 | 1,21 | Pz0-100 | 1,16 |
| Pz 1 | 25 | Pz1-2 | 1,30 | Pz1-5 | 0,81 | Pz1-50 | 0,73 | Pz1-100 | 0,68 |
| Pz 2 | 25 | Pz2-2 | 1,30 | Pz2-5 | 0,81 | Pz2-50 | 0,73 | Pz2-100 | 0,68 |
| Pz 3 | 25 | Pz3-2 | 1,30 | Pz3-5 | 0,81 | Pz3-50 | 0,73 | Pz3-100 | 0,68 |

FENDA

| € x Bit | L1 mm | 2 Uds | | 5 Uds | | 50 Uds | | 100 Uds | |
|---------|----------|------------|-------------|------------|-------------|-------------|-------------|--------------|-------------|
| | | | € | | € | | € | | € |
| 0,5X3,0 | 25 | P0,5X3,0-2 | 1,76 | P0,5X3,0-5 | 1,52 | P0,5X3,0-50 | 1,38 | P0,5X3,0-100 | 1,31 |
| 0,6X3,5 | 25 | P0,6X3,5-2 | 1,76 | P0,6X3,5-5 | 1,52 | P0,6X3,5-50 | 1,38 | P0,6X3,5-100 | 1,31 |
| 0,5X4,0 | 25 | P0,5X4,0-2 | 1,76 | P0,5X4,0-5 | 1,52 | P0,5X4,0-50 | 1,38 | P0,5X4,0-100 | 1,31 |
| 0,6X4,5 | 25 | P0,6X4,5-2 | 1,76 | P0,6X4,5-5 | 1,52 | P0,6X4,5-50 | 1,38 | P0,6X4,5-100 | 1,31 |
| 0,8X4,0 | 25 | P0,8X4,0-2 | 1,76 | P0,8X4,0-5 | 1,52 | P0,8X4,0-50 | 1,38 | P0,8X4,0-100 | 1,31 |
| 0,8X5,0 | 25 | P0,8X5,0-2 | 1,76 | P0,8X5,0-5 | 1,52 | P0,8X5,0-50 | 1,38 | P0,8X5,0-100 | 1,31 |
| 0,8X5,5 | 25 | P0,8X5,5-2 | 1,76 | P0,8X5,5-5 | 1,52 | P0,8X5,5-50 | 1,38 | P0,8X5,5-100 | 1,31 |
| 1,0X5,5 | 25 | P1X5,5-2 | 1,76 | P1X5,5-5 | 1,52 | P1X5,5-50 | 1,38 | P1X5,5-100 | 1,31 |
| 1,0X6,0 | 25 | P1X6,0-2 | 1,76 | P1X6,0-5 | 1,52 | P1X6,0-50 | 1,38 | P1X6,0-100 | 1,31 |
| 1,2X6,5 | 25 | P1,2X6,5-2 | 1,76 | P1,2X6,5-5 | 1,52 | P1,2X6,5-50 | 1,38 | P1,2X6,5-100 | 1,31 |
| 1,2X8,0 | 25 | P1,2X8,0-2 | 1,76 | P1,2X8,0-5 | 1,52 | P1,2X8,0-50 | 1,38 | P1,2X8,0-100 | 1,31 |

BITS INTERCAMBIÁVEIS



25mm
COMPR.
TOTAL
(L)

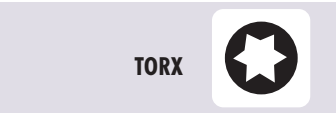

| € x Bit | | 2 Uds | | 5 Uds | | 50 Uds | | 100 Uds | |
|---------|-------|--------|------|--------|------|---------|------|----------|------|
| | L1 mm | | € | | € | | € | | € |
| T5 | 25 | PT5-2 | 2,32 | PT5-5 | 2,01 | PT5-50 | 1,82 | PT5-100 | 1,72 |
| T6 | 25 | PT6-2 | 2,32 | PT6-5 | 2,01 | PT6-50 | 1,82 | PT6-100 | 1,72 |
| T7 | 25 | PT7-2 | 2,32 | PT7-5 | 2,01 | PT7-50 | 1,82 | PT7-100 | 1,72 |
| T8 | 25 | PT8-2 | 2,32 | PT8-5 | 2,01 | PT8-50 | 1,82 | PT8-100 | 1,72 |
| T9 | 25 | PT9-2 | 2,32 | PT9-5 | 2,01 | PT9-50 | 1,82 | PT9-100 | 1,72 |
| T10 | 25 | PT10-2 | 1,91 | PT10-5 | 1,49 | PT10-50 | 1,33 | PT10-100 | 1,26 |
| T15 | 25 | PT15-2 | 1,91 | PT15-5 | 1,49 | PT15-50 | 1,33 | PT15-100 | 1,26 |
| T20 | 25 | PT20-2 | 1,91 | PT20-5 | 1,49 | PT20-50 | 1,33 | PT20-100 | 1,26 |
| T25 | 25 | PT25-2 | 1,91 | PT25-5 | 1,49 | PT25-50 | 1,33 | PT25-100 | 1,26 |
| T27 | 25 | PT27-2 | 1,91 | PT27-5 | 1,49 | PT27-50 | 1,33 | PT27-100 | 1,26 |
| T30 | 25 | PT30-2 | 1,91 | PT30-5 | 1,49 | PT30-50 | 1,33 | PT30-100 | 1,26 |
| T40 | 25 | PT40-2 | 1,91 | PT40-5 | 1,49 | PT40-50 | 1,33 | PT40-100 | 1,26 |

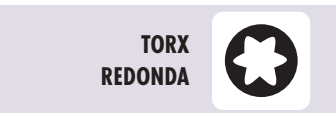

| € x Bit | | 2 Uds | | 5 Uds | | 50 Uds | | 100 Uds | |
|---------|-------|---------|------|---------|------|----------|------|-----------|------|
| | L1 mm | | € | | € | | € | | € |
| TR10 | 25 | PTR10-2 | 6,17 | PTR10-5 | 5,36 | PTR10-50 | 4,84 | PTR10-100 | 4,55 |
| TR15 | 25 | PTR15-2 | 6,17 | PTR15-5 | 5,36 | PTR15-50 | 4,84 | PTR15-100 | 4,55 |
| TR20 | 25 | PTR20-2 | 6,17 | PTR20-5 | 5,36 | PTR20-50 | 4,84 | PTR20-100 | 4,55 |
| TR25 | 25 | PTR25-2 | 6,17 | PTR25-5 | 5,36 | PTR25-50 | 4,84 | PTR25-100 | 4,55 |
| TR30 | 25 | PTR30-2 | 6,17 | PTR30-5 | 5,36 | PTR30-50 | 4,84 | PTR30-100 | 4,55 |
| TR40 | 25 | PTR40-2 | 6,17 | PTR40-5 | 5,36 | PTR40-50 | 4,84 | PTR40-100 | 4,55 |

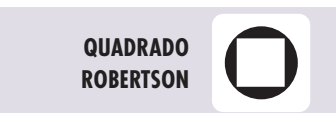

| € x Bit | | 2 Uds | | 5 Uds | | 50 Uds | | 100 Uds | |
|---------|-------|-------|------|-------|------|--------|------|---------|------|
| | L1 mm | | € | | € | | € | | € |
| Nº1 | 25 | PC1-2 | 2,48 | PC1-5 | 2,17 | PC1-50 | 1,95 | PC1-100 | 1,84 |
| Nº2 | 25 | PC2-2 | 2,48 | PC2-5 | 2,17 | PC2-50 | 1,95 | PC2-100 | 1,84 |
| Nº3 | 25 | PC3-2 | 2,48 | PC3-5 | 2,17 | PC3-50 | 1,95 | PC3-100 | 1,84 |

BITS INTERCAMBIÁVEIS
Plus

25mm
 COMPR.
 TOTAL
 (L)

**TORX DE
 SEGURANÇA**

| € x Bit | | 2 Uds | | 5 Uds | | 50 Uds | | 100 Uds | |
|---------|----------|---------|-------------|---------|-------------|----------|-------------|-----------|-------------|
| | L1 mm | | € | | € | | € | | € |
| TS10 | 25 | PTS10-2 | 3,31 | PTS10-5 | 2,87 | PTS10-50 | 2,59 | PTS10-100 | 2,44 |
| TS15 | 25 | PTS15-2 | 3,31 | PTS15-5 | 2,87 | PTS15-50 | 2,59 | PTS15-100 | 2,44 |
| TS20 | 25 | PTS20-2 | 3,31 | PTS20-5 | 2,87 | PTS20-50 | 2,59 | PTS20-100 | 2,44 |
| TS25 | 25 | PTS25-2 | 3,31 | PTS25-5 | 2,87 | PTS25-50 | 2,59 | PTS25-100 | 2,44 |
| TS27 | 25 | PTS27-2 | 3,31 | PTS27-5 | 2,87 | PTS27-50 | 2,59 | PTS27-100 | 2,44 |
| TS30 | 25 | PTS30-2 | 3,31 | PTS30-5 | 2,87 | PTS30-50 | 2,59 | PTS30-100 | 2,44 |
| TS40 | 25 | PTS40-2 | 3,31 | PTS40-5 | 2,87 | PTS40-50 | 2,59 | PTS40-100 | 2,44 |

**CABEÇA
 SEXTAVADA**

| € x Bit | | 2 Uds | | 5 Uds | | 50 Uds | | 100 Uds | |
|---------|----------|----------|-------------|----------|-------------|-----------|-------------|------------|-------------|
| | L1 mm | | € | | € | | € | | € |
| 2 mm | 25 | PHX2-2 | 1,83 | PHX2-5 | 1,66 | PHX2-50 | 1,48 | PHX2-100 | 1,42 |
| 2,5 mm | 25 | PHX2,5-2 | 1,83 | PHX2,5-5 | 1,66 | PHX2,5-50 | 1,48 | PHX2,5-100 | 1,42 |
| 3 mm | 25 | PHX3-2 | 1,83 | PHX3-5 | 1,66 | PHX3-50 | 1,48 | PHX3-100 | 1,42 |
| 4 mm | 25 | PHX4-2 | 1,83 | PHX4-5 | 1,66 | PHX4-50 | 1,48 | PHX4-100 | 1,42 |
| 5 mm | 25 | PHX5-2 | 1,83 | PHX5-5 | 1,66 | PHX5-50 | 1,48 | PHX5-100 | 1,42 |
| 6 mm | 25 | PHX6-2 | 1,83 | PHX6-5 | 1,66 | PHX6-50 | 1,48 | PHX6-100 | 1,42 |
| 8 mm | 25 | PHX8-2 | 2,17 | PHX8-5 | 1,97 | PHX8-50 | 1,90 | PHX8-100 | 1,79 |

**TRI
 WING**

| € x Bit | | 2 Uds | | 5 Uds | | 50 Uds | | 100 Uds | |
|---------|----------|---------|--------------|---------|-------------|----------|-------------|-----------|-------------|
| | L1 mm | | € | | € | | € | | € |
| Nº4 | 25 | PTRW4-2 | 10,92 | PTRW4-5 | 9,50 | PTRW4-50 | 8,55 | PTRW4-100 | 8,08 |
| Nº5 | 25 | PTRW5-2 | 10,92 | PTRW5-5 | 9,50 | PTRW5-50 | 8,55 | PTRW5-100 | 8,08 |
| Nº6 | 25 | PTRW6-2 | 10,92 | PTRW6-5 | 9,50 | PTRW6-50 | 8,55 | PTRW6-100 | 8,08 |
| Nº8 | 25 | PTRW8-2 | 10,92 | PTRW8-5 | 9,50 | PTRW8-50 | 8,55 | PTRW8-100 | 8,08 |

XZN

| € x Bit | | 2 Uds | | 5 Uds | | 50 Uds | | 100 Uds | |
|---------|----------|----------|-------------|----------|-------------|-----------|-------------|------------|-------------|
| | L1 mm | | € | | € | | € | | € |
| Nº4 | 25 | PXZN4-2 | 6,69 | PXZN4-5 | 5,83 | PXZN4-50 | 5,24 | PXZN4-100 | 4,95 |
| Nº5 | 25 | PXZN5-2 | 6,69 | PXZN5-5 | 5,83 | PXZN5-50 | 5,24 | PXZN5-100 | 4,95 |
| Nº6 | 25 | PXZN6-2 | 6,69 | PXZN6-5 | 5,83 | PXZN6-50 | 5,24 | PXZN6-100 | 4,95 |
| Nº8 | 25 | PXZN8-2 | 7,51 | PXZN8-5 | 6,53 | PXZN8-50 | 6,41 | PXZN8-100 | 6,29 |
| Nº10 | 25 | PXZN10-2 | 7,51 | PXZN10-5 | 6,53 | PXZN10-50 | 6,41 | PXZN10-100 | 6,29 |

BITS INTERCAMBIÁVEIS

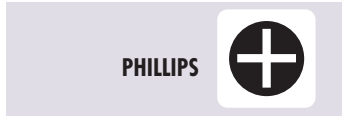

| € x Bit | | 2 Uds | | 5 Uds | | 50 Uds | |
|---------|-------|----------|-------------|----------|-------------|-----------|-------------|
| | L1 mm | | € | | € | | € |
| Ph 1 | 50 | Ph1X50-2 | 2,97 | Ph1X50-5 | 2,59 | Ph1X50-50 | 2,33 |
| Ph 2 | 50 | Ph2X50-2 | 2,97 | Ph2X50-5 | 2,59 | Ph2X50-50 | 2,33 |
| Ph 3 | 50 | Ph3X50-2 | 2,97 | Ph3X50-5 | 2,59 | Ph3X50-50 | 2,33 |
| Ph 4 | 50 | Ph4X50-2 | - | Ph4X50-5 | - | Ph4X50-50 | - |

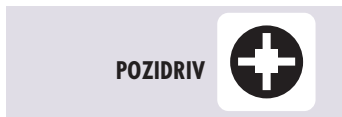

| € x Bit | | 2 Uds | | 5 Uds | | 50 Uds | |
|---------|-------|----------|-------------|----------|-------------|-----------|-------------|
| | L1 mm | | € | | € | | € |
| Pz 1 | 50 | Pz1X50-2 | 2,97 | Pz1X50-5 | 2,59 | Pz1X50-50 | 2,33 |
| Pz 2 | 50 | Pz2X50-2 | 2,97 | Pz2X50-5 | 2,59 | Pz2X50-50 | 2,33 |
| Pz 3 | 50 | Pz3X50-2 | 2,97 | Pz3X50-5 | 2,59 | Pz3X50-50 | 2,33 |
| Pz 4 | 50 | Pz4X50-2 | - | Pz4X50-5 | - | Pz4X50-50 | - |

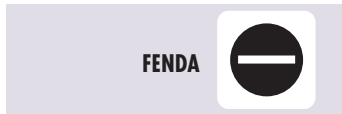

| € x Bit | | 2 Uds | | 5 Uds | | 50 Uds | |
|---------|-------|---------------|--------------|---------------|--------------|----------------|--------------|
| | L1 mm | | € | | € | | € |
| 0,5X4,0 | 50 | P0,5X4,0X50-2 | 4,69 | P0,5X4,0X50-5 | 4,06 | P0,5X4,0X50-50 | 3,64 |
| 0,5X3,0 | 50 | P0,5X3,0X50-2 | 4,69 | P0,5X3,0X50-5 | 4,06 | P0,5X3,0X50-50 | 3,64 |
| 0,6X3,5 | 50 | P0,6X3,5X50-2 | 4,69 | P0,6X3,5X50-5 | 4,06 | P0,6X3,5X50-50 | 3,64 |
| 0,6X4,5 | 50 | P0,6X4,5X50-2 | 4,69 | P0,6X4,5X50-5 | 4,06 | P0,6X4,5X50-50 | 3,64 |
| 0,8X4,0 | 50 | P0,8X4,0X50-2 | 4,69 | P0,8X4,0X50-5 | 4,06 | P0,8X4,0X50-50 | 3,64 |
| 0,8X5,0 | 50 | P0,8X5,0X50-2 | 4,69* | P0,8X5,0X50-5 | 4,06* | P0,8X5,0X50-50 | 3,64* |
| 0,8X5,5 | 50 | P0,8X5,5X50-2 | 4,69 | P0,8X5,5X50-5 | 4,06 | P0,8X5,5X50-50 | 3,64 |
| 1,0X5,5 | 50 | P1X5,5X50-2 | 4,69 | P1X5,5X50-5 | 4,06 | P1X5,5X50-50 | 3,64 |
| 1,0X6,0 | 50 | P1X6,0X50-2 | 4,69 | P1X6,0X50-5 | 4,06 | P1X6,0X50-50 | 3,64 |
| 1,2X6,5 | 50 | P1,2X6,5X50-2 | 4,69 | P1,2X6,5X50-5 | 4,06 | P1,2X6,5X50-50 | 3,64 |
| 1,2X8,0 | 50 | P1,2X8,0X50-2 | 4,69 | P1,2X8,0X50-5 | 4,06 | P1,2X8,0X50-50 | 3,64 |

*Ate o fim das existencias

BITS INTERCAMBIÁVEIS
Plus

50mm
 COMPR.
 TOTAL
 (L.)

TORX

| € x Bit | | 2 Uds | | 5 Uds | | 50 Uds | |
|---------|----------|-----------|------|-----------|------|------------|------|
| | L1 mm | | € | | € | | € |
| T 5 | 50 | PT5X50-2 | 6,00 | PT5X50-5 | 4,57 | PT5X50-50 | 4,23 |
| T 6 | 50 | PT6X50-2 | 6,00 | PT6X50-5 | 4,57 | PT6X50-50 | 4,23 |
| T 7 | 50 | PT7X50-2 | 6,00 | PT7X50-5 | 4,57 | PT7X50-50 | 4,23 |
| T 8 | 50 | PT8X50-2 | 6,00 | PT8X50-5 | 4,57 | PT8X50-50 | 4,23 |
| T 9 | 50 | PT9X50-2 | 6,00 | PT9X50-5 | 4,57 | PT9X50-50 | 4,23 |
| T 10 | 50 | PT10X50-2 | 5,52 | PT10X50-5 | 4,30 | PT10X50-50 | 3,87 |
| T 15 | 50 | PT15X50-2 | 5,52 | PT15X50-5 | 4,30 | PT15X50-50 | 3,87 |
| T 20 | 50 | PT20X50-2 | 5,52 | PT20X50-5 | 4,30 | PT20X50-50 | 3,87 |
| T 25 | 50 | PT25X50-2 | 5,52 | PT25X50-5 | 4,30 | PT25X50-50 | 3,87 |
| T 27 | 50 | PT27X50-2 | 5,52 | PT27X50-5 | 4,30 | PT27X50-50 | 3,87 |
| T 30 | 50 | PT30X50-2 | 5,52 | PT30X50-5 | 4,30 | PT30X50-50 | 3,87 |
| T 40 | 50 | PT40X50-2 | 5,52 | PT40X50-5 | 4,30 | PT40X50-50 | 3,87 |

**QUADRADO
ROBERTSON**

| € x Bit | | 2 Uds | | 5 Uds | | 50 Uds | |
|---------|----------|----------|------|----------|------|-----------|------|
| | L1 mm | | € | | € | | € |
| Nº1 | 50 | PC1X50-2 | 7,20 | PC1X50-5 | 6,26 | PC1X50-50 | 5,64 |
| Nº2 | 50 | PC2X50-2 | 7,20 | PC2X50-5 | 6,26 | PC2X50-50 | 5,64 |
| Nº3 | 50 | PC3X50-2 | 7,20 | PC3X50-5 | 6,26 | PC3X50-50 | 5,64 |

SEXTAVADA

| € x Bit | | 2 Uds | | 5 Uds | | 50 Uds | |
|---------|----------|-------------|------|-------------|------|--------------|------|
| | L1 mm | | € | | € | | € |
| 2 mm | 50 | PHX2X50-2 | 5,83 | PHX2X50-5 | 5,07 | PHX2X50-50 | 4,56 |
| 2,5 mm | 50 | PHX2,5X50-2 | 5,83 | PHX2,5X50-5 | 5,07 | PHX2,5X50-50 | 4,56 |
| 3 mm | 50 | PHX3X50-2 | 5,83 | PHX3X50-5 | 5,07 | PHX3X50-50 | 4,56 |
| 4 mm | 50 | PHX4X50-2 | 5,83 | PHX4X50-5 | 5,07 | PHX4X50-50 | 4,56 |
| 5 mm | 50 | PHX5X50-2 | 5,83 | PHX5X50-5 | 5,07 | PHX5X50-50 | 4,56 |
| 6 mm | 50 | PHX6X50-2 | 5,83 | PHX6X50-5 | 5,07 | PHX6X50-50 | 4,56 |
| 8 mm | 50 | PHX8X50-2 | 7,47 | PHX8X50-5 | 6,84 | PHX8X50-50 | 5,85 |

BITS INTERCAMBIÁVEIS

Plus ★★ **70mm** COMPR. TOTAL (L₁)

PHILLIPS



| € x Bit | | 2 Uds | | 5 Uds | |
|---------|-------|----------|-------------|----------|-------------|
| | L1 mm | | € | | € |
| Ph 1 | 70 | Ph1X70-2 | 6,97 | Ph1X70-5 | 6,07 |
| Ph 2 | 70 | Ph2X70-2 | 6,97 | Ph2X70-5 | 6,07 |
| Ph 3 | 70 | Ph3X70-2 | 6,97 | Ph3X70-5 | 6,07 |
| Ph 4 | 70 | Ph4X70-2 | - | Ph4X70-5 | - |

POZIDRIV



| € x Bit | | 2 Uds | | 5 Uds | |
|---------|-------|----------|-------------|----------|-------------|
| | L1 mm | | € | | € |
| Pz 1 | 70 | Pz1X70-2 | 7,04 | Pz1X70-5 | 6,12 |
| Pz 2 | 70 | Pz2X70-2 | 7,04 | Pz2X70-5 | 6,12 |
| Pz 3 | 70 | Pz3X70-2 | 7,04 | Pz3X70-5 | 6,12 |
| Pz 4 | 70 | Pz4X70-2 | - | Pz4X70-5 | - |

Plus ★★ **90mm** COMPR. TOTAL (L₁)

PHILLIPS



| € x Bit | | 2 Uds | | 5 Uds | |
|---------|-------|----------|-------------|----------|-------------|
| | L1 mm | | € | | € |
| Ph 1 | 90 | Ph1X90-2 | 8,59 | Ph1X90-5 | 7,48 |
| Ph 2 | 90 | Ph2X90-2 | 8,59 | Ph2X90-5 | 7,48 |
| Ph 3 | 90 | Ph3X90-2 | 8,59 | Ph3X90-5 | 7,48 |
| Ph 4 | 90 | Ph4X90-2 | - | Ph4X90-5 | - |

POZIDRIV



| € x Bit | | 2 Uds | | 5 Uds | |
|---------|-------|----------|-------------|----------|-------------|
| | L1 mm | | € | | € |
| Pz 1 | 90 | Pz1X90-2 | 8,67 | Pz1X90-5 | 7,55 |
| Pz 2 | 90 | Pz2X90-2 | 8,67 | Pz2X90-5 | 7,55 |
| Pz 3 | 90 | Pz3X90-2 | 8,67 | Pz3X90-5 | 7,55 |
| Pz 4 | 90 | Pz4X90-2 | - | Pz4X90-5 | - |

BITS INTERCAMBIÁVEIS
TiN

25mm
 COMPR.
 TOTAL
 (L.)

PHILLIPS

| € x Bit | | 2 Uds | | 5 Uds | | 50 Uds | |
|---------|-------|--------|-------------|--------|-------------|---------|-------------|
| | L1 mm | | € | | € | | € |
| Ph 1 | 25 | Ph1T-2 | 3,51 | Ph1T-5 | 2,65 | Ph1T-50 | 2,38 |
| Ph 2 | 25 | Ph2T-2 | 3,51 | Ph2T-5 | 2,65 | Ph2T-50 | 2,38 |
| Ph 3 | 25 | Ph3T-2 | 3,51 | Ph3T-5 | 2,65 | Ph3T-50 | 2,38 |

POZIDRIV

| € x Bit | | 2 Uds | | 5 Uds | | 50 Uds | |
|---------|-------|--------|-------------|--------|-------------|---------|-------------|
| | L1 mm | | € | | € | | € |
| Pz 1 | 25 | Pz1T-2 | 3,54 | Pz1T-5 | 2,67 | Pz1T-50 | 2,41 |
| Pz 2 | 25 | Pz2T-2 | 3,54 | Pz2T-5 | 2,67 | Pz2T-50 | 2,41 |
| Pz 3 | 25 | Pz3T-2 | 3,54 | Pz3T-5 | 2,67 | Pz3T-50 | 2,41 |

FENDA

| € x Bit | | 2 Uds | | 5 Uds | | 50 Uds | |
|---------|-------|-------------|-------------|-------------|-------------|--------------|-------------|
| | L1 mm | | € | | € | | € |
| 0,6X4,5 | 25 | PO,6X4,5T-2 | 3,80 | PO,6X4,5T-5 | 3,29 | PO,6X4,5T-50 | 2,96 |
| 0,8X5,5 | 25 | PO,8X5,5T-2 | 3,80 | PO,8X5,5T-5 | 3,29 | PO,8X5,5T-50 | 2,96 |
| 1,0X5,5 | 25 | P1X5,5T-2 | 3,80 | P1X5,5T-5 | 3,29 | P1X5,5T-50 | 2,96 |
| 1,2X6,5 | 25 | P1,2X6,5T-2 | 3,80 | P1,2X6,5T-5 | 3,29 | P1,2X6,5T-50 | 2,96 |

TORX

| € x Bit | | 2 Uds | | 5 Uds | | 50 Uds | |
|---------|-------|---------|-------------|---------|-------------|----------|-------------|
| | L1 mm | | € | | € | | € |
| T 10 | 25 | PT10T-2 | 3,65 | PT10T-5 | 3,28 | PT10T-50 | 2,87 |
| T 15 | 25 | PT15T-2 | 3,65 | PT15T-5 | 3,28 | PT15T-50 | 2,87 |
| T 20 | 25 | PT20T-2 | 3,65 | PT20T-5 | 3,28 | PT20T-50 | 2,87 |
| T 25 | 25 | PT25T-2 | 3,65 | PT25T-5 | 3,28 | PT25T-50 | 2,87 |
| T 27 | 25 | PT27T-2 | 3,65 | PT27T-5 | 3,28 | PT27T-50 | 2,87 |
| T 30 | 25 | PT30T-2 | 3,65 | PT30T-5 | 3,28 | PT30T-50 | 2,87 |
| T 40 | 25 | PT40T-2 | 3,65 | PT40T-5 | 3,28 | PT40T-50 | 2,87 |

BITS INTERCAMBIÁVEIS

TiN  **50mm** COMPR. TOTAL (L.)



PHILLIPS 



| € x Bit | L1 mm | 2 Uds | € | 5 Uds | € | 50 Uds | € |
|---------|-------|-----------|-------------|-----------|-------------|------------|-------------|
| Ph 1 | 50 | Ph1Tx50-2 | 8,09 | Ph1Tx50-5 | 7,03 | Ph1Tx50-50 | 6,31 |
| Ph 2 | 50 | Ph2Tx50-2 | 8,09 | Ph2Tx50-5 | 7,03 | Ph2Tx50-50 | 6,31 |
| Ph 3 | 50 | Ph3Tx50-2 | 8,09 | Ph3Tx50-5 | 7,03 | Ph3Tx50-50 | 6,31 |

POZIDRIV 



| € x Bit | L1 mm | 2 Uds | € | 5 Uds | € | 50 Uds | € |
|---------|-------|-----------|-------------|-----------|-------------|------------|-------------|
| Pz 1 | 50 | Pz1Tx50-2 | 8,17 | Pz1Tx50-5 | 7,10 | Pz1Tx50-50 | 6,37 |
| Pz 2 | 50 | Pz2Tx50-2 | 8,17 | Pz2Tx50-5 | 7,10 | Pz2Tx50-50 | 6,37 |
| Pz 3 | 50 | Pz3Tx50-2 | 8,17 | Pz3Tx50-5 | 7,10 | Pz3Tx50-50 | 6,37 |

TORX 



| € x Bit | L1 mm | 2 Uds | € | 5 Uds | € | 50 Uds | € |
|---------|-------|------------|--------------|------------|--------------|-------------|-------------|
| T 10 | 50 | PT10Tx50-2 | 11,57 | PT10Tx50-5 | 10,06 | PT10Tx50-50 | 9,05 |
| T 15 | 50 | PT15Tx50-2 | 11,57 | PT15Tx50-5 | 10,06 | PT15Tx50-50 | 9,05 |
| T 20 | 50 | PT20Tx50-2 | 11,57 | PT20Tx50-5 | 10,06 | PT20Tx50-50 | 9,05 |
| T 25 | 50 | PT25Tx50-2 | 11,57 | PT25Tx50-5 | 10,06 | PT25Tx50-50 | 9,05 |
| T 27 | 50 | PT27Tx50-2 | 11,57 | PT27Tx50-5 | 10,06 | PT27Tx50-50 | 9,05 |
| T 30 | 50 | PT30Tx50-2 | 11,57 | PT30Tx50-5 | 10,06 | PT30Tx50-50 | 9,05 |
| T 40 | 50 | PT40Tx50-2 | 11,57 | PT40Tx50-5 | 10,06 | PT40Tx50-50 | 9,05 |

PORTA-BITS MÁGNÉTICOS

PORTA-BITS MÁGNÉTICOS

| | L1 mm | TIPO DE CABO | € |
|-----------|----------|--------------------|--------|
| PMGx51 | 51 | MAGNÉTICO SEM ANEL | 6,99 |
| PMGx58 | 58 | MAGNÉTICO SEM ANEL | 7,26 |
| PMGx74 | 74 | MAGNÉTICO COM ANEL | 11,97 |
| PMGx100 | 100 | MAGNÉTICO COM ANEL | 14,48 |
| PMGx150 | 150 | MAGNÉTICO COM ANEL | 16,13 |
| PMGx200 | 200 | MAGNÉTICO COM ANEL | 19,09 |
| PMGx250 | 250 | MAGNÉTICO COM ANEL | 29,36 |
| PMGSDSx78 | 78 | SDS PLUS | 20,03 |
| PBERx74 | 74 | BERILIO | 51,40* |
| PDESSx70 | 70 | 5/16" DESSOUTTER | 31,67* |
| P7x74 | 74 | 7mm Fein | 34,40* |

*Ate o fim das existencias



PORTA-BITS MAGNÉTICO COM MUDANÇA RÁPIDA APTO PARA BITS DE 1/4" COM COLARINHO

| | L1 mm | TIPO DE CABO | € |
|-----------|----------|---|-------|
| PCR60 | 60 | Mudança rápida 1/4" Apto para bits de 1/4" com colarinho | 17,81 |
| PCR74 | 74 | Mudança rápida 1/4" Apto para bits de 1/4" com colarinho | 18,34 |
| PCRSDSX80 | 80 | SDS PLUS | 29,21 |



PORTA-BITS MAGNÉTICO COM ANEL MAGNÉTICO FRONTAL PARA SUJEÇÃO DE PARAFUSOS

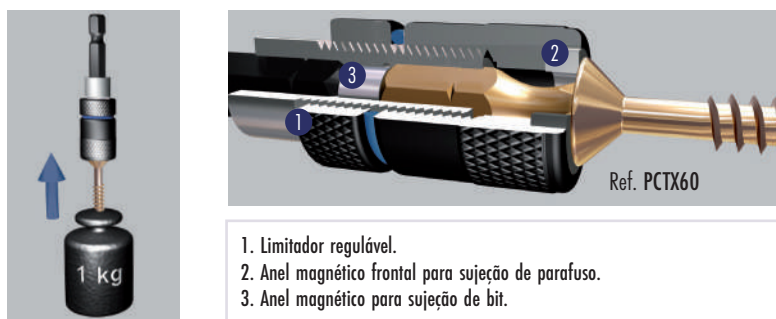

| | L1 mm | TIPO DE CABO | € |
|--------|----------|------------------------------------|-------|
| PCTX60 | 60 | Porta-bits com limitador regulável | 16,77 |



CHAVES DE CAIXA MAGNÉTICAS SEXTAVADAS



SEXTAVADA MÁGNÉTICA



| | mm | " | | €/ 1U. |
|-------------|------|------------|---|--------|
| PLIHX5-2 | 5,0 | | 2 | 6,35 |
| PLIHX5,5-2 | 5,5 | | 2 | 6,35 |
| PLIHX6-2 | 6,0 | | 2 | 6,35 |
| PLIHX1/4-2 | | 1/4"=6,35 | 2 | 6,35 |
| PLIHX7-2 | 7,0 | | 2 | 6,49 |
| PLIHX5/16-2 | | 5/16"=7,93 | 2 | 6,49 |
| PLIHX8-2 | 8,0 | | 2 | 6,49 |
| PLIHX3/8-2 | | 3/8"=9,52 | 2 | 6,49 |
| PLIHX10-2 | 10,0 | | 2 | 6,65 |
| PLIHX11-2 | 11,0 | | 2 | 6,84 |
| PLIHX12-2 | 12,0 | | 2 | 6,90 |
| PLIHX13-2 | 13,0 | | 2 | 7,23 |

ESTOJOS DE 7 PEÇAS DE CHAVES DE CAIXA MAGNÉTICAS SEXTAVADAS

| REFERÊNCIA | EPLL |
|------------|---|
| Nº CHAVES | 7 |
| CONTEÚDO | HX1/4 - HX7 - HX8 - HX3/8 HX10 - HX12 - HX13 |
| P.V.P. € | 47,09 |



CHAVE DE BITS COM ROQUETE + ARMAZÉM DE BITS E EXPOSITOR PARA CHAVES



1. Alta qualidade e rendimento.
2. Giro a direitas e esquerdas.
3. Cabo telescópico ajustável em comprimento.
4. Feito em aço e plástico de alta resistência.

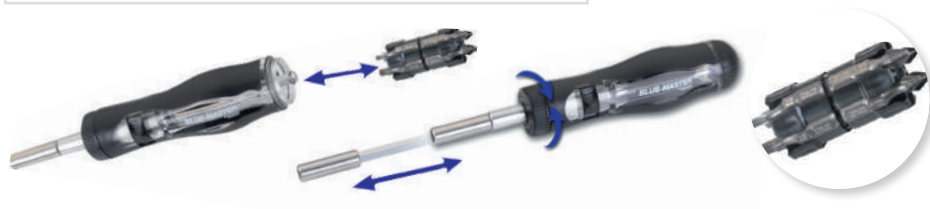
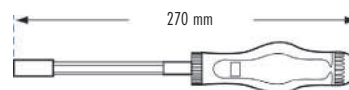
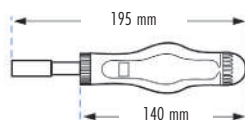

DTRC

- Conteúdo da chave:
- PH1 - PH2
 - PZ1 - PZ2
 - T15 - T20 - T25 - T30

35,77 €

ESTOJOS DE BITS INTERCAMBIÁVEIS

ESTOJOS DE 7 PEÇAS QUALIDADE PLUS E TIN



Ref. EPT1





| REFERÊNCIA | EPT1 | EPT2 | EPT3 |
|------------|---|---|--|
| Nº PEÇAS | 7 | 7 | 7 |
| CONTEÚDO | PH1 - PH2 PZ1 - PZ2 0,8x5,5 - 1,2x6,5 1 Porta-bits PMG | T10 - T15 T20 - T25 T30 - T40 1 Porta-bits PMG | PH1 - PH2 - PH3 PZ1 - PZ2 - PZ3 1 Porta-bits PMG |
| P.V.P. € | 12,45 | 16,78 | 14,92 |







Ref. EPTT1

| REFERÊNCIA | EPTT1 | EPTT2 | EPTT3 |
|------------|---|---|--|
| Nº PEÇAS | 7 | 7 | 7 |
| CONTEÚDO | PH1 - PH2 PZ1 - PZ2 0,8x5,5 - 1,2x6,5 1 Porta-bits PMG | T10 - T15 T20 - T25 T30 - T40 1 Porta-bits PMG | PH1 - PH2 - PH3 PZ1 - PZ2 - PZ3 1 Porta-bits PMG |
| P.V.P. € | 35,31 | 40,95 | 34,04 |





ESTOJOS DE BITS INTERCAMBIÁVEIS
ESTOJOS DE 12 PEÇAS QUALIDADE PLUS E TIN

| | | | |
|---|------------|---|---|
|  Ref. EPT4 | REFERÊNCIA | EPT4 | EPT5 |
| | Nº PEÇAS | 12 | 12 |
|  Plus | CONTEÚDO | + PH1 - PH2(2) - PH3 + PZ1 - PZ2(2) - PZ3 - 0,6x4,5 - 0,8x5,5 - 1,2x6,5 1 Porta-bits PMG | ★ T10 - T15(2) ★ T20(2) - T25(2) T27 - T30(2) - T40 1 Porta-bits PMG |
| | P.V.P. € | 16,70 | 22,93 |
|  Ref. EPTT4 | REFERÊNCIA | EPTT4 | EPTT5 |
| | Nº PEÇAS | 12 | 12 |
|  TiN | CONTEÚDO | + PH1 - PH2(2) - PH3 + PZ1 - PZ2(2) - PZ3 - 0,6x4,5 - 0,8x5,5 - 1,2x6,5 1 Porta-bits PCT | ★ T10 - T15(2) ★ T20(2) - T25(2) T27 - T30(2) - T40 1 Porta-bits PCT |
| | P.V.P. € | 44,47 | 52,31 |

ESTOJOS DE 31 PEÇAS QUALIDADE PLUS E TIN

| | | |
|---|------------|--|
|  Ref. EPT6 | REFERÊNCIA | EPT6 |
| | Nº PEÇAS | 31 |
|  Plus | CONTEÚDO | + PH1(3) - PH2(3) - PH3(3) + PZ1(3) - PZ2(3) - PZ3(3) - 0,6x4,5 - 0,8x5,5 - 1,2x6,5 ★ T10 - T15 - T20 - T25 - T30 - T40 ○ H3 - H4 - H5 1 Porta-bits PMG |
| | P.V.P. € | 47,72 |
|  Ref. EPTT6 | REFERÊNCIA | EPTT6 |
| | Nº PEÇAS | 31 |
|  TiN | CONTEÚDO | + PH1(3) - PH2(3) - PH3(3) + PZ1(3) - PZ2(3) - PZ3(3) - 0,6x4,5 - 0,8x5,5 - 1,2x6,5 ★ T10 - T15 - T20 - T25 - T30 - T40 ○ H3 - H4 - H5 1 Porta-bits PCT |
| | P.V.P. € | 101,25 |

ESTOJOS DE 36 PEÇAS QUALIDADE PLUS E TIN

| | | |
|--|------------|--|
|  Ref. EPT7 | REFERÊNCIA | EPT7 |
| | Nº PEÇAS | 36 |
|  Plus | CONTEÚDO | + PH1(3) - PH2(3) - PH3(3) + PZ1(3) - PZ2(3) - PZ3(3) - 0,5 x 4 - 0,6 x 4,5 - 0,8 x 5 - 0,8 x 5,5 - 1 x 6 - 1,2 x 6,5 - 1,2 x 8 ★ T10 - T15 - T20 - T25 - T27 - T30 - T40 ○ H2 - H2,5 - H3 - H4 - H5 - H6 - H8 1 Porta-bits PMG |
| | P.V.P. € | 60,43 |
|  Ref. EPTT7 | REFERÊNCIA | EPTT7* |
| | Nº PEÇAS | 36 |
|  TiN | CONTEÚDO | + PH1(3) - PH2(3) - PH3(3) + PZ1(3) - PZ2(3) - PZ3(3) - 0,5 x 4 - 0,6 x 4,5 - 0,8 x 5 - 0,8 x 5,5 - 1 x 6 - 1,2 x 6,5 - 1,2 x 8 ★ T10 - T15 - T20 - T25 - T27 - T30 - T40 ○ H2 - H2,5 - H3 - H4 - H5 - H6 - H8 1 Porta-bits PCT |
| | P.V.P. € | 123,99* |

*Ate o fim das existencias

ESTOJOS DE BITS INTERCAMBIÁVEIS

ESTOJOS DE 45 E 80 PEÇAS QUALIDADE *Plus*



Ref. EPT45



Ref. EPT80



| | | |
|------------|---|---|
| REFERÊNCIA | EPT45 | |
| Nº PEÇAS | 45 | |
| CONTEÚDO | <ul style="list-style-type: none"> PH1(2) - PH2(2) - PH3(2) PZ1(2) - PZ2(2) - PZ3(2) 0,5x3-0,6x4,5-0,8x5,5(2)-1,2x6,5-1,6x8 H2,5 - H3 - H4 - H5 - H6 - H7 T10 - T15 - T20 - T25 - T30 - T40 | <ul style="list-style-type: none"> Chaves de caixa sextavadas (mm): 5 - 6 - 7 - 8 - 9 - 10 - 11 - 12 - 13 - 14 1 Adaptador para chaves de caixa 1 Adaptador para bits 1 Porta-bits magnético PCR 1 Chave de roquete de 72 dentes 1 Chave de parafusos |
| P.V.P. € | 151,21 | |



| | | |
|------------|---|---|
| REFERÊNCIA | EPT80* | |
| Nº PEÇAS | 80 | |
| CONTEÚDO | <ul style="list-style-type: none"> PH0 - PH1 - PH2(4) - PH3(2) PZ1 - PZ2(4) - PZ3(2) 0,5x3-0,6x4,5-0,8x5,5(2)-1,2x6,5-1,6x8 H2 - H2,5 - H3 - H4 - H5 - H6 - H7 - H8 TW1 - TW2 - TW3 - TW4 - TW5 TQ5 - TQ6 - TQ8 - TQ10 T5 - T6 - T7 - T8 - T9 - T10 - T15 T20(2) - T25(2) - T27 - T30 - T40 TS10 - TS15 - TS20 - TS25 - TS30 - TS40 | <ul style="list-style-type: none"> C0 - C1 - C2 - C3 SP4 - SP6 - SP8 - SP10 HS3 - HS4 - HS5 - HS6 1 Porta-bits magnético PCR 1 Chave de parafusos PH1 - PH2 PZ1 - PZ2 T15 - T20 - T25 - T30 |
| P.V.P. € | 155,24* | |

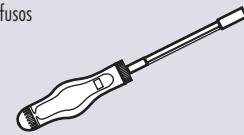

*Ate o fim das existencias

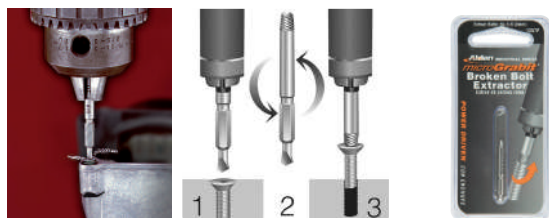
EXTRATORES DE MÁQUINAS PARA PARAFUSOS QUEBRADOS
MICRO GRABIT

| | | EP |
|--------|----|-------|
| | | € |
| EP451C | M3 | 55,10 |
| EP452C | M4 | 55,10 |
| EP453C | M5 | 55,10 |
| EP454C | M6 | 55,10 |

1. Furar no parafuso.
2. Dar a volta.
3. Extrair.

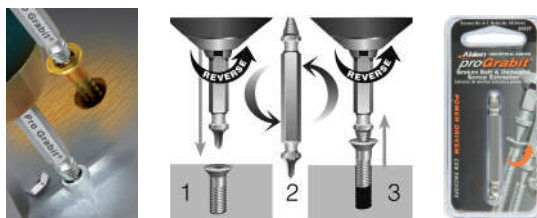
PRO GRABIT COM CORPO SEXTAVADO 1/4"

| | | EP |
|---------|-----|-------|
| | | € |
| EP8401C | M5 | 43,70 |
| EP8402C | M6 | 51,63 |
| EP8403C | M8 | 51,63 |
| EP8404C | M10 | 54,18 |

1. Furar no parafuso.
2. Dar a volta.
3. Extrair.

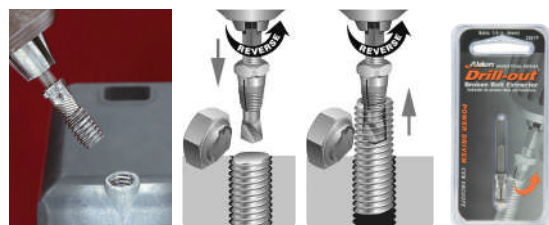
DRILL OUT EXTRATOR DE PARAFUSOS QUEBRADOS COM BROCA GUIA (M6-M12)

| | | EP |
|--------|-----|-------|
| | | € |
| EP205C | M6 | 53,42 |
| EP312C | M8 | 64,73 |
| EP375C | M10 | 64,73 |
| EP500C | M12 | 72,86 |

X-OUT EXTRATOR DE PARAFUSOS QUEBRADOS COM CABO SEXTAVADO (M3-M5)

| | | EP |
|---------|----|-------|
| | | € |
| EP3701C | M3 | 43,70 |
| EP3702C | M4 | 43,70 |
| EP3703C | M5 | 48,57 |

ESTOJOS DE EXTRATORES DE MÁQUINA PARA PARAFUSOS QUEBRADOS
MICRO GRABIT

DRILL-OUT

| | |
|------------|-------------|
| REFERÊNCIA | EP450C |
| Nº PEÇAS | 4 |
| CONTEÚDO | M3-M4-M5-M6 |
| P.V.P. € | 226,00 |

| | |
|------------|---------------|
| REFERÊNCIA | EP401C |
| Nº PEÇAS | 4 |
| CONTEÚDO | M6-M8-M10-M12 |
| P.V.P. € | 265,87 |

EXTRATORES LAMINADOS MANUAIS PARA PARAFUSOS QUEBRADOS

JOGOS DE EXTRATORES CLÁSSICOS DE PARAFUSOS

Fazer um furo no centro com a broca BLUE-MASTER recomendada, introduzir o extrator no furo, girar o extrator à esquerda até extrair o estrator.

| REFERÊNCIA | EX/1-5 | EX/1-6 | EX/1-8 |
|------------|--------------|--------------|--------------|
| Nº PEÇAS | 5 | 6 | 8 |
| CONTEÚDO | M3 - M18 | M3 - M24 | M3 - M45 |
| P.V.P. € | 23,38 | 31,64 | 73,03 |

Ref. EX/1-6



| | Para PARAFUSOS | mm | mm | L1 mm | Ø min mm | Ø max. mm | EX € |
|------|----------------|------|------|-------|----------|-----------|--------------|
| EX/1 | M3 - M6 | 3,2 | 2,5 | 51 | 1,75 | 3,95 | 2,90 |
| EX/2 | M6 - M8 | 4,0 | 3,0 | 60 | 2,20 | 4,80 | 2,90 |
| EX/3 | M8 - M11 | 5,1 | 4,5 | 68 | 3,30 | 6,40 | 3,44 |
| EX/4 | M11 - M14 | 6,2 | 6,0 | 76 | 4,75 | 8,40 | 4,26 |
| EX/5 | M14 - M18 | 8,6 | 8,0 | 86 | 6,35 | 11,00 | 5,54 |
| EX/6 | M18 - M24 | 12,0 | 11,0 | 95 | 9,50 | 15,00 | 9,38 |
| EX/7 | M24 - M33 | 15,9 | 14,0 | 105 | 12,70 | 19,00 | 25,40 |
| EX/8 | M33 - M45 | 20,0 | 21,0 | 111 | 19,00 | 25,00 | 41,61 |

| REFERÊNCIA | EXTT |
|----------------|--------------------------|
| Nº PEÇAS | 10 |
| EXTRATORES | EX/1-EX/2-EX/3-EX/4-EX/5 |
| BROCAS PREVIAS | Ref. BC3 Ø2,5-3-4,5-6-8 |
| P.V.P. € | 39,01 |

EXTRATORES MANUAIS FRESADOS PARA PARAFUSOS QUEBRADOS



| | Para PARAFUSOS | mm | mm | L1 mm | Ø min mm | Ø max. mm | EFX € |
|-------|----------------|------|------|-------|----------|-----------|--------------|
| EFX/1 | M3-M6 | 2,9 | 2,0 | 50 | 1,9 | 3,2 | 3,69 |
| EFX/2 | M6-M8 | 3,9 | 3,2 | 60 | 2,8 | 5,0 | 3,69 |
| EFX/3 | M8-M11 | 4,8 | 4,0 | 68 | 3,2 | 6,5 | 4,35 |
| EFX/4 | M11-M14 | 6,7 | 6,4 | 75 | 5,2 | 9,0 | 5,40 |
| EFX/5 | M14-M18 | 8,5 | 7,1 | 85 | 6,4 | 11,0 | 7,00 |
| EFX/6 | M18-M25 | 11,8 | 9,5 | 95 | 9,4 | 15,0 | 11,88 |
| EFX/7 | M25-M35 | 14,3 | 12,7 | 106 | 12,8 | 19,0 | 32,16 |
| EFX/8 | M35-M45 | 19,5 | 19,5 | 110 | 19,3 | 25,0 | 52,67 |

Ref. EFX/1-5



| REFERÊNCIA | EFX/1-5 |
|------------|--------------|
| Nº PEÇAS | 5 |
| CONTEÚDO | M3 - M18 |
| P.V.P. € | 28,16 |

BROCA PARA METAL DIN 338

Ref. BH2

HSS



OX



| | Ø mm | L1 x L2 mm | mm | BH2 € |
|---------|-------|------------|------|--------------|
| BH20200 | 2,00 | 61 x 33 | 1/4" | 7,52 |
| BH20300 | 3,00 | 61 x 33 | 1/4" | 7,69 |
| BH20400 | 4,00 | 75 x 43 | 1/4" | 8,14 |
| BH20500 | 5,00 | 86 x 52 | 1/4" | 10,12 |
| BH20600 | 6,00 | 93 x 57 | 1/4" | 10,93 |
| BH20700 | 7,00 | 109 x 69 | 1/4" | 13,78 |
| BH20800 | 8,00 | 117 x 75 | 1/4" | 15,47 |
| BH20900 | 9,00 | 125 x 81 | 1/4" | 17,40 |
| BH21000 | 10,00 | 133 x 87 | 1/4" | 19,38 |



| REFERÊNCIA | BH29335 | BH29333 |
|------------|----------------|-----------------------|
| Nº BROCAS | 5 | 8 |
| QUALIDADE | HSS | HSS |
| CONTEÚDO | Ø 3-4-5-6-8 mm | Ø 3-4-5-6-7-8-9-10 mm |
| P.V.P. € | 53,15 | 71,10 |

FERRAMENTAS COM CABO SEXTAVADO 1/4"
BROCA PARA METAL EXTRA-CURTA
HSS-G

Ref. BC59

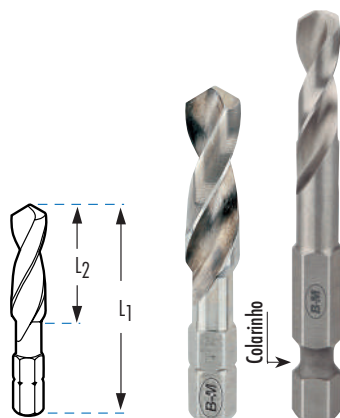
BROCA-MACHO ESCAREADOR
HSS-G

Ref. MAHM

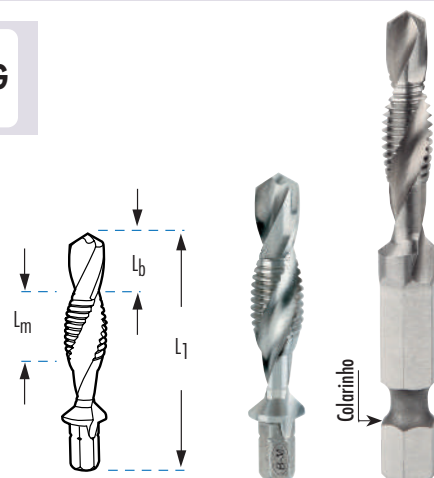

| | | | | BC59 | BC59CR |
|----------|-------|------------|------|-------|--------|
| | Ø mm | L1 x L2 mm | | € | € |
| BC590100 | 1,00 | 34 x 12 | 1/4" | 7,52 | - |
| BC590150 | 1,50 | 34 x 12 | 1/4" | 7,52 | - |
| BC590200 | 2,00 | 34 x 12 | 1/4" | 7,52 | 7,52 |
| BC590250 | 2,50 | 36 x 14 | 1/4" | 7,52 | 7,52 |
| BC590300 | 3,00 | 38 x 16 | 1/4" | 7,52 | 7,52 |
| BC590330 | 3,30 | 40 x 18 | 1/4" | 7,52 | 7,52 |
| BC590350 | 3,50 | 40 x 18 | 1/4" | 7,52 | 7,52 |
| BC590400 | 4,00 | 44 x 20 | 1/4" | 7,52 | 7,52 |
| BC590420 | 4,20 | 45 x 20 | 1/4" | 7,52 | 7,52 |
| BC590450 | 4,50 | 46 x 24 | 1/4" | 7,52 | 7,52 |
| BC590500 | 5,00 | 50 x 26 | 1/4" | 7,52 | 7,52 |
| BC590550 | 5,50 | 50 x 26 | 1/4" | 8,21 | 8,21 |
| BC590600 | 6,00 | 50 x 26 | 1/4" | 8,21 | 8,21 |
| BC590650 | 6,50 | 50 x 30 | 1/4" | 8,21 | 8,21 |
| BC590680 | 6,80 | 50 x 30 | 1/4" | 8,21 | 8,21 |
| BC590700 | 7,00 | 50 x 30 | 1/4" | 8,21 | 8,21 |
| BC590750 | 7,50 | 51 x 32 | 1/4" | 9,29 | 9,29 |
| BC590800 | 8,00 | 51 x 32 | 1/4" | 9,29 | 9,29 |
| BC590850 | 8,50 | 53 x 33 | 1/4" | 9,29 | 9,29 |
| BC590900 | 9,00 | 53 x 33 | 1/4" | 11,21 | 11,21 |
| BC590950 | 9,50 | 54 x 38 | 1/4" | 11,21 | 11,21 |
| BC591000 | 10,00 | 54 x 38 | 1/4" | 11,21 | 11,21 |
| BC591020 | 10,20 | 54 x 38 | 1/4" | 11,21 | 11,21 |

| | | | MAHM | MAHMCRCR | |
|--|-----------------|--------------|------|----------|-------|
| | L1 x Lb x Lm mm | | € | € | |
| | M 3 x 0,50 | 36 x 5 x 6 | 1/4" | 24,53 | 24,53 |
| | M 4 x 0,70 | 39 x 6 x 7 | 1/4" | 24,53 | 24,53 |
| | M 5 x 0,80 | 41 x 8 x 8 | 1/4" | 25,60 | 25,60 |
| | M 6 x 1,00 | 44 x 8 x 10 | 1/4" | 26,66 | 26,66 |
| | M 8 x 1,25 | 50 x 10 x 11 | 1/4" | 36,86 | 36,86 |
| | M 10 x 1,50 | 59 x 11 x 11 | 1/4" | 44,47 | 44,47 |



| | |
|-------------------|------------------|
| REFERÊNCIA | MAH9327CR |
| Nº BROCAS | 5 |
| REFERÊNCIA BROCAS | MAHMCRCR |
| CONTEÚDO | M4-M5-M6-M8-M10 |
| P.V.P. € | 182,64 |

MACHO HSS-G
HSS-G

Ref. M

| | | | M | MCR | |
|--|-------------|---------|------|-------|-------|
| | L1 x L2 mm | | € | € | |
| | M 3 x 0,50 | 33 x 11 | 1/4" | 8,90 | 8,90 |
| | M 4 x 0,70 | 35 x 12 | 1/4" | 8,90 | 8,90 |
| | M 5 x 0,80 | 36 x 15 | 1/4" | 11,34 | 11,34 |
| | M 6 x 1,00 | 39 x 18 | 1/4" | 11,34 | 11,34 |
| | M 8 x 1,25 | 40 x 19 | 1/4" | 15,70 | 15,70 |
| | M 10 x 1,50 | 41 x 21 | 1/4" | 19,39 | 19,39 |

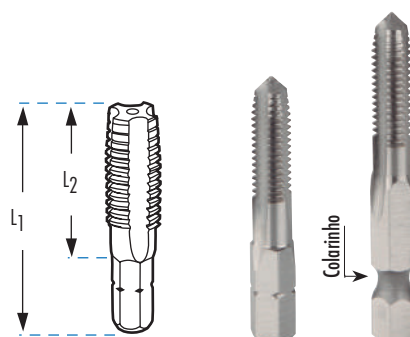

FERRAMENTAS COM CABO SEXTAVADO 1/4"

BROCA MACHO HSSCo STEP CUT

NEW

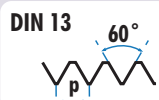

HSSCo
5%

BRILHANTE

TOL
6H

D
CABO
FINO



Ref. MTKM

STEP CUT

| | | | | | | | | | | MTKM | |
|---|---------|---|------|------|-----|-------|------|-----|------|------|-------|
| | | | | | | | | | | € | |
| M | 3x0,50 | D | 7,0 | 6,0 | 6,0 | 57,0 | 2,5 | 2,2 | 7,3 | 1/4" | 28,21 |
| M | 4x0,70 | D | 7,0 | 8,5 | 6,0 | 62,0 | 3,3 | 3,0 | 7,3 | 1/4" | 28,21 |
| M | 5x0,80 | D | 9,0 | 10,0 | 6,0 | 69,0 | 4,2 | 3,7 | 7,3 | 1/4" | 29,44 |
| M | 6x1,00 | D | 10,0 | 12,0 | 6,0 | 73,0 | 5,0 | 4,5 | 7,3 | 1/4" | 30,66 |
| M | 8x1,25 | D | 12,0 | 16,0 | 6,0 | 87,0 | 6,8 | 6,3 | 9,4 | 1/4" | 42,38 |
| M | 10x1,50 | D | 14,0 | 20,0 | 6,0 | 96,0 | 8,5 | 8,0 | 11,4 | 1/4" | 51,14 |
| M | 12x1,75 | D | 16,0 | 24,0 | 8,0 | 112,0 | 10,3 | 9,8 | 13,4 | 1/4" | 56,36 |

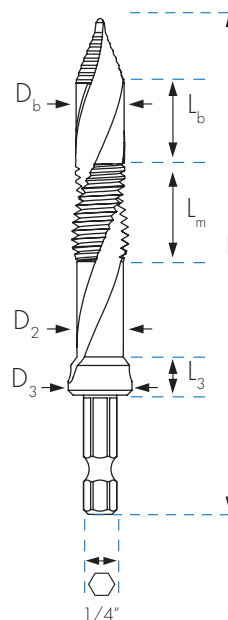

ESCREADOR DE 3 CANAIS

HSS-G

Ref. AV22

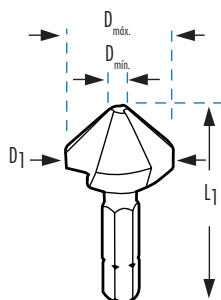

ESCREADOR PARA REBARBAR

HSS



Ref. AV1...CR

Ref. AV101CR
Ref. AV102CR

Ref. AV103CR
Ref. AV104CR

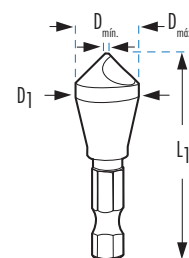

| | | | | | AV22 |
|-------|----|----------------|------|-------|------|
| D1 | L1 | D min. -D max. | | € | |
| 6,30 | 31 | 1,50 - 5,8 | 1/4" | 22,65 | |
| 8,30 | 31 | 2,00 - 7,8 | 1/4" | 22,65 | |
| 10,40 | 34 | 2,50 - 10,0 | 1/4" | 24,27 | |
| 12,40 | 35 | 2,80 - 12,0 | 1/4" | 25,89 | |
| 16,50 | 40 | 3,20 - 16,0 | 1/4" | 27,73 | |
| 20,50 | 41 | 3,50 - 20,0 | 1/4" | 33,27 | |

| | | | | | AV1...CR |
|---------|-------|----|----------------|------|----------|
| | D1 | L1 | D min. -D max. | | € |
| AV101CR | 10,00 | 40 | 2,0 - 5,0 | 1/4" | 22,66 |
| AV102CR | 14,00 | 42 | 5,0 - 10,0 | 1/4" | 28,33 |
| AV103CR | 17,00 | 45 | 5,0 - 13,0 | 1/4" | 50,73 |
| AV104CR | 25,00 | 55 | 7,0 - 20,0 | 1/4" | 90,60 |

FERRAMENTAS COM CABO SEXTAVADO 1/4"
BROCA PARA PAREDE

Ref. BWH

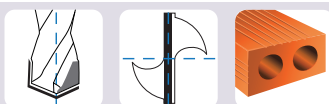

BROCA PARA MADEIRA

Ref. BMH

CV



| BWH | | | | |
|-------|------|------------|---|-------|
| | Ø mm | L1 x L2 mm |  | € |
| BWH03 | 3 | 70 x 30 | 1/4" | 3,23 |
| BWH04 | 4 | 70 x 30 | 1/4" | 3,50 |
| BWH05 | 5 | 85 x 45 | 1/4" | 3,79 |
| BWH06 | 6 | 100 x 50 | 1/4" | 4,21 |
| BWH07 | 7 | 100 x 50 | 1/4" | 4,95 |
| BWH08 | 8 | 120 x 70 | 1/4" | 5,72 |
| BWH09 | 9 | 120 x 70 | 1/4" | 6,85 |
| BWH10 | 10 | 120 x 70 | 1/4" | 7,67 |
| BWH11 | 11 | 150 x 80 | 1/4" | 9,54 |
| BWH12 | 12 | 150 x 80 | 1/4" | 10,78 |
| BWH13 | 13 | 150 x 80 | 1/4" | 13,27 |
| BWH14 | 14 | 150 x 80 | 1/4" | 15,46 |

| BMH | | | | |
|-------|------|------------|---|-------|
| | Ø mm | L1 x L2 mm |  | € |
| BMH03 | 3 | 59 x 35 | 1/4" | 2,07 |
| BMH04 | 4 | 74 x 41 | 1/4" | 2,17 |
| BMH05 | 5 | 82 x 55 | 1/4" | 2,15 |
| BMH06 | 6 | 88 x 58 | 1/4" | 2,90 |
| BMH07 | 7 | 110 x 70 | 1/4" | 3,29 |
| BMH08 | 8 | 110 x 70 | 1/4" | 3,42 |
| BMH09 | 9 | 110 x 70 | 1/4" | 3,56 |
| BMH10 | 10 | 115 x 75 | 1/4" | 3,94 |
| BMH11 | 11 | 135 x 85 | 1/4" | 4,60 |
| BMH12 | 12 | 135 x 85 | 1/4" | 5,40 |
| BMH13 | 13 | 135 x 90 | 1/4" | 8,45 |
| BMH14 | 14 | 145 x 95 | 1/4" | 10,51 |



| REFERÊNCIA | BWH9318 | BWH9327 | BWH9319 | BMH9335 | BMH9333 |
|------------|------------------------|-------------------------|-------------------------------------|------------------------|-------------------------------------|
| Nº BROCAS | 5 | 5 | 8 | 5 | 8 |
| APLICAÇÃO | PAREDE | PAREDE | PAREDE | MADEIRA | MADEIRA |
| CONTEÚDO | Ø 3 - 4 - 5 - 6 - 8 mm | Ø 4 - 5 - 6 - 8 - 10 mm | Ø 3 - 4 - 5 - 6 - 7 - 8 - 9 - 10 mm | Ø 3 - 4 - 5 - 6 - 8 mm | Ø 3 - 4 - 5 - 6 - 7 - 8 - 9 - 10 mm |
| P.V.P. € | 27,28 | 32,92 | 37,70 | 16,93 | 22,33 |

ESTOJOS DE FERRAMENTAS COM CABO SEXTAVADO 1/4"

Ref. EB



Ref. EMBP

CONTEÚDO

| |  HSS-G |  HSS-G |  |  | € |
|------|---|---|---|---|--------|
| EM | M3 - M4 - M5 - M6 M8 - M10 | - | - | - | 72,19 |
| EMBP | M3 - M4 - M5 - M6 M8 - M10 | Ø 2,50 - 3,30 - 4,20 5 - 6,80 - 8,50 | - | - | 104,08 |
| EBM | - | - | M3 - M4 - M5 - M6 M8 - M10 | - | 158,91 |
| EA | - | - | - | Ø 6,30 - 8,30 - 10,40 12,40 - 16,50 - 20,50 | 145,70 |
| EB | - | Ø 1 - 10 mm x 0,50 | - | - | 121,39 |