

**BLUE-MASTER®**  
by *celesa*



INSERTI PER  
AVVITATORE

**INSERTI INTERCAMBIABILI PER AVVITATORE**

Inserti per Avvitatore

Rosa

 25mm  
 LUNG.  
 TOTALE  
 (L<sub>1</sub>)

**PHILLIPS**

€ x Inserto		2 U.		5 U.		50 U.		100 U.	
	L1 mm		€		€		€		€
Ph 0	25	Ph0-2	<b>1,63</b>	Ph0-5	<b>1,44</b>	Ph0-50	<b>1,28</b>	Ph0-100	<b>1,22</b>
Ph 1	25	Ph1-2	<b>1,38</b>	Ph1-5	<b>0,85</b>	Ph1-50	<b>0,77</b>	Ph1-100	<b>0,72</b>
Ph 2	25	Ph2-2	<b>1,38</b>	Ph2-5	<b>0,85</b>	Ph2-50	<b>0,77</b>	Ph2-100	<b>0,72</b>
Ph 3	25	Ph3-2	<b>1,38</b>	Ph3-5	<b>0,85</b>	Ph3-50	<b>0,77</b>	Ph3-100	<b>0,72</b>

**POZIDRIV**

€ x Inserto		2 U.		5 U.		50 U.		100 U.	
	L1 mm		€		€		€		€
Pz 0	25	Pz0-2	<b>1,63</b>	Pz0-5	<b>1,44</b>	Pz0-50	<b>1,28</b>	Pz0-100	<b>1,22</b>
Pz 1	25	Pz1-2	<b>1,38</b>	Pz1-5	<b>0,85</b>	Pz1-50	<b>0,77</b>	Pz1-100	<b>0,72</b>
Pz 2	25	Pz2-2	<b>1,38</b>	Pz2-5	<b>0,85</b>	Pz2-50	<b>0,77</b>	Pz2-100	<b>0,72</b>
Pz 3	25	Pz3-2	<b>1,38</b>	Pz3-5	<b>0,85</b>	Pz3-50	<b>0,77</b>	Pz3-100	<b>0,72</b>

**TESTA  
PIATTA**

€ x Inserto		2 U.		5 U.		50 U.		100 U.	
	L1 mm		€		€		€		€
0,5X3,0	25	P0,5X3,0-2	<b>1,85</b>	P0,5X3,0-5	<b>1,60</b>	P0,5X3,0-50	<b>1,45</b>	P0,5X3,0-100	<b>1,37</b>
0,6X3,5	25	P0,6X3,5-2	<b>1,85</b>	P0,6X3,5-5	<b>1,60</b>	P0,6X3,5-50	<b>1,45</b>	P0,6X3,5-100	<b>1,37</b>
0,5X4,0	25	P0,5X4,0-2	<b>1,85</b>	P0,5X4,0-5	<b>1,60</b>	P0,5X4,0-50	<b>1,45</b>	P0,5X4,0-100	<b>1,37</b>
0,6X4,5	25	P0,6X4,5-2	<b>1,85</b>	P0,6X4,5-5	<b>1,60</b>	P0,6X4,5-50	<b>1,45</b>	P0,6X4,5-100	<b>1,37</b>
0,8X4,0	25	P0,8X4,0-2	<b>1,85</b>	P0,8X4,0-5	<b>1,60</b>	P0,8X4,0-50	<b>1,45</b>	P0,8X4,0-100	<b>1,37</b>
0,8X5,0	25	P0,8X5,0-2	<b>1,85</b>	P0,8X5,0-5	<b>1,60</b>	P0,8X5,0-50	<b>1,45</b>	P0,8X5,0-100	<b>1,37</b>
0,8X5,5	25	P0,8X5,5-2	<b>1,85</b>	P0,8X5,5-5	<b>1,60</b>	P0,8X5,5-50	<b>1,45</b>	P0,8X5,5-100	<b>1,37</b>
1,0X5,5	25	P1X5,5-2	<b>1,85</b>	P1X5,5-5	<b>1,60</b>	P1X5,5-50	<b>1,45</b>	P1X5,5-100	<b>1,37</b>
1,0X6,0	25	P1X6,0-2	<b>1,85</b>	P1X6,0-5	<b>1,60</b>	P1X6,0-50	<b>1,45</b>	P1X6,0-100	<b>1,37</b>
1,2X6,5	25	P1,2X6,5-2	<b>1,85</b>	P1,2X6,5-5	<b>1,60</b>	P1,2X6,5-50	<b>1,45</b>	P1,2X6,5-100	<b>1,37</b>
1,2X8,0	25	P1,2X8,0-2	<b>1,85</b>	P1,2X8,0-5	<b>1,60</b>	P1,2X8,0-50	<b>1,45</b>	P1,2X8,0-100	<b>1,37</b>

**INSERTI INTERCAMBIABILI PER AVVITATORE**



**25mm**  
LUNG.  
TOTALE  
(L<sub>1</sub>)

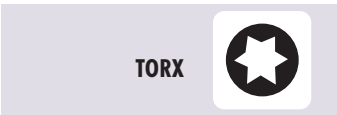

€ x Inserto		2 U.		5 U.		50 U.		100 U.	
	L1 mm		€		€		€		€
T5	25	PT5-2	2,43	PT5-5	2,11	PT5-50	1,90	PT5-100	1,80
T6	25	PT6-2	2,43	PT6-5	2,11	PT6-50	1,90	PT6-100	1,80
T7	25	PT7-2	2,43	PT7-5	2,11	PT7-50	1,90	PT7-100	1,80
T8	25	PT8-2	2,43	PT8-5	2,11	PT8-50	1,90	PT8-100	1,80
T9	25	PT9-2	2,43	PT9-5	2,11	PT9-50	1,90	PT9-100	1,80
T10	25	PT10-2	2,00	PT10-5	1,56	PT10-50	1,39	PT10-100	1,32
T15	25	PT15-2	2,00	PT15-5	1,56	PT15-50	1,39	PT15-100	1,32
T20	25	PT20-2	2,00	PT20-5	1,56	PT20-50	1,39	PT20-100	1,32
T25	25	PT25-2	2,00	PT25-5	1,56	PT25-50	1,39	PT25-100	1,32
T27	25	PT27-2	2,00	PT27-5	1,56	PT27-50	1,39	PT27-100	1,32
T30	25	PT30-2	2,00	PT30-5	1,56	PT30-50	1,39	PT30-100	1,32
T40	25	PT40-2	2,00	PT40-5	1,56	PT40-50	1,39	PT40-100	1,32

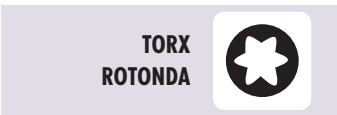

€ x Inserto		2 U.		5 U.		50 U.		100 U.	
	L1 mm		€		€		€		€
TR10	25	PTR10-2	6,47	PTR10-5	5,62	PTR10-50	5,07	PTR10-100	4,77
TR15	25	PTR15-2	6,47	PTR15-5	5,62	PTR15-50	5,07	PTR15-100	4,77
TR20	25	PTR20-2	6,47	PTR20-5	5,62	PTR20-50	5,07	PTR20-100	4,77
TR25	25	PTR25-2	6,47	PTR25-5	5,62	PTR25-50	5,07	PTR25-100	4,77
TR30	25	PTR30-2	6,47	PTR30-5	5,62	PTR30-50	5,07	PTR30-100	4,77
TR40	25	PTR40-2	6,47	PTR40-5	5,62	PTR40-50	5,07	PTR40-100	4,77

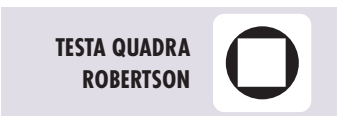

€ x Inserto		2 U.		5 U.		50 U.		100 U.	
	L1 mm		€		€		€		€
N°1	25	PC1-2	2,60	PC1-5	2,27	PC1-50	2,04	PC1-100	1,93
N°2	25	PC2-2	2,60	PC2-5	2,27	PC2-50	2,04	PC2-100	1,93
N°3	25	PC3-2	2,60	PC3-5	2,27	PC3-50	2,04	PC3-100	1,93

**INSERTI INTERCAMBIABILI PER AVVITATORE**
**Plus**

**25mm**  
 LUNG.  
 TOTALE  
 (L.)

Inserti per Avvitatore

Rosa

**TORX®**  
**TAMPER RESISTANT**

€ x Insetto		2 U.		5 U.		50 U.		100 U.	
	L1 mm		€		€		€		€
TS10	25	PTS10-2	<b>3,47</b>	PTS10-5	<b>3,01</b>	PTS10-50	<b>2,71</b>	PTS10-100	<b>2,56</b>
TS15	25	PTS15-2	<b>3,47</b>	PTS15-5	<b>3,01</b>	PTS15-50	<b>2,71</b>	PTS15-100	<b>2,56</b>
TS20	25	PTS20-2	<b>3,47</b>	PTS20-5	<b>3,01</b>	PTS20-50	<b>2,71</b>	PTS20-100	<b>2,56</b>
TS25	25	PTS25-2	<b>3,47</b>	PTS25-5	<b>3,01</b>	PTS25-50	<b>2,71</b>	PTS25-100	<b>2,56</b>
TS27	25	PTS27-2	<b>3,47</b>	PTS27-5	<b>3,01</b>	PTS27-50	<b>2,71</b>	PTS27-100	<b>2,56</b>
TS30	25	PTS30-2	<b>3,47</b>	PTS30-5	<b>3,01</b>	PTS30-50	<b>2,71</b>	PTS30-100	<b>2,56</b>
TS40	25	PTS40-2	<b>3,47</b>	PTS40-5	<b>3,01</b>	PTS40-50	<b>2,71</b>	PTS40-100	<b>2,56</b>

**TESTA**  
**ESAGONALE**

€ x Insetto		2 U.		5 U.		50 U.		100 U.	
	L1 mm		€		€		€		€
2 mm	25	PHX2-2	<b>1,92</b>	PHX2-5	<b>1,74</b>	PHX2-50	<b>1,55</b>	PHX2-100	<b>1,49</b>
2,5 mm	25	PHX2,5-2	<b>1,92</b>	PHX2,5-5	<b>1,74</b>	PHX2,5-50	<b>1,55</b>	PHX2,5-100	<b>1,49</b>
3 mm	25	PHX3-2	<b>1,92</b>	PHX3-5	<b>1,74</b>	PHX3-50	<b>1,55</b>	PHX3-100	<b>1,49</b>
4 mm	25	PHX4-2	<b>1,92</b>	PHX4-5	<b>1,74</b>	PHX4-50	<b>1,55</b>	PHX4-100	<b>1,49</b>
5 mm	25	PHX5-2	<b>1,92</b>	PHX5-5	<b>1,74</b>	PHX5-50	<b>1,55</b>	PHX5-100	<b>1,49</b>
6 mm	25	PHX6-2	<b>1,92</b>	PHX6-5	<b>1,74</b>	PHX6-50	<b>1,55</b>	PHX6-100	<b>1,49</b>
8 mm	25	PHX8-2	<b>2,27</b>	PHX8-5	<b>2,07</b>	PHX8-50	<b>1,94</b>	PHX8-100	<b>1,88</b>

**TRI**  
**WING**

€ x Insetto		2 U.		5 U.		50 U.		100 U.	
	L1 mm		€		€		€		€
N°4	25	PTRW4-2	<b>11,45</b>	PTRW4-5	<b>9,95</b>	PTRW4-50	<b>8,96</b>	PTRW4-100	<b>8,46</b>
N°5	25	PTRW5-2	<b>11,45</b>	PTRW5-5	<b>9,95</b>	PTRW5-50	<b>8,96</b>	PTRW5-100	<b>8,46</b>
N°6	25	PTRW6-2	<b>11,45</b>	PTRW6-5	<b>9,95</b>	PTRW6-50	<b>8,96</b>	PTRW6-100	<b>8,46</b>
N°8	25	PTRW8-2	<b>11,45</b>	PTRW8-5	<b>9,95</b>	PTRW8-50	<b>8,96</b>	PTRW8-100	<b>8,46</b>

**XZN**

€ x Insetto		2 U.		5 U.		50 U.		100 U.	
	L1 mm		€		€		€		€
N°4	25	PXZN4-2	<b>7,02</b>	PXZN4-5	<b>6,10</b>	PXZN4-50	<b>5,49</b>	PXZN4-100	<b>5,19</b>
N°5	25	PXZN5-2	<b>7,02</b>	PXZN5-5	<b>6,10</b>	PXZN5-50	<b>5,49</b>	PXZN5-100	<b>5,19</b>
N°6	25	PXZN6-2	<b>7,02</b>	PXZN6-5	<b>6,10</b>	PXZN6-50	<b>5,49</b>	PXZN6-100	<b>5,19</b>
N°8	25	PXZN8-2	<b>11,00</b>	PXZN8-5	<b>9,58</b>	PXZN8-50	<b>8,30</b>	PXZN8-100	<b>8,14</b>
N°10	25	PXZN10-2	<b>11,00</b>	PXZN10-5	<b>9,58</b>	PXZN10-50	<b>8,30</b>	PXZN10-100	<b>8,14</b>

**INSERTI INTERCAMBIABILI PER AVVITATORE**



**Plus** ★★ **50mm**  
LUNG. TOTALE (L<sub>1</sub>)

**PHILLIPS**



€ x Insetto		2 U.		5 U.		50 U.	
	L1 mm		€		€		€
Ph 1	50	Ph1X50-2	<b>3,14</b>	Ph1X50-5	<b>2,74</b>	Ph1X50-50	<b>2,46</b>
Ph 2	50	Ph2X50-2	<b>3,14</b>	Ph2X50-5	<b>2,74</b>	Ph2X50-50	<b>2,46</b>
Ph 3	50	Ph3X50-2	<b>3,14</b>	Ph3X50-5	<b>2,74</b>	Ph3X50-50	<b>2,46</b>
Ph 4	50	Ph4X50-2	-	Ph4X50-5	-	Ph4X50-50	-

**POZIDRIV**



€ x Insetto		2 U.		5 U.		50 U.	
	L1 mm		€		€		€
Pz 1	50	Pz1X50-2	<b>3,14</b>	Pz1X50-5	<b>2,74</b>	Pz1X50-50	<b>2,46</b>
Pz 2	50	Pz2X50-2	<b>3,14</b>	Pz2X50-5	<b>2,74</b>	Pz2X50-50	<b>2,46</b>
Pz 3	50	Pz3X50-2	<b>3,14</b>	Pz3X50-5	<b>2,74</b>	Pz3X50-50	<b>2,46</b>
Pz 4	50	Pz4X50-2	-	Pz4X50-5	-	Pz4X50-50	-

**TESTA PIATTA**



€ x Insetto		2 U.		5 U.		50 U.	
	L1 mm		€		€		€
0,5X4,0	50	P0,5X4,0X50-2	<b>4,90</b>	P0,5X4,0X50-5	<b>4,26</b>	P0,5X4,0X50-50	<b>3,81</b>
0,5X3,0	50	P0,5X3,0X50-2	<b>4,90</b>	P0,5X3,0X50-5	<b>4,26</b>	P0,5X3,0X50-50	<b>3,81</b>
0,6X3,5	50	P0,6X3,5X50-2	<b>4,90</b>	P0,6X3,5X50-5	<b>4,26</b>	P0,6X3,5X50-50	<b>3,81</b>
0,6X4,5	50	P0,6X4,5X50-2	<b>4,90</b>	P0,6X4,5X50-5	<b>4,26</b>	P0,6X4,5X50-50	<b>3,81</b>
0,8X4,0	50	P0,8X4,0X50-2	<b>4,90</b>	P0,8X4,0X50-5	<b>4,26</b>	P0,8X4,0X50-50	<b>3,81</b>
0,8X5,0	50	P0,8X5,0X50-2	<b>4,90*</b>	P0,8X5,0X50-5	<b>4,26*</b>	P0,8X5,0X50-50	<b>3,81*</b>
0,8X5,5	50	P0,8X5,5X50-2	<b>4,90</b>	P0,8X5,5X50-5	<b>4,26</b>	P0,8X5,5X50-50	<b>3,81</b>
1,0X5,5	50	P1X5,5X50-2	<b>4,90</b>	P1X5,5X50-5	<b>4,26</b>	P1X5,5X50-50	<b>3,81</b>
1,0X6,0	50	P1X6,0X50-2	<b>4,90</b>	P1X6,0X50-5	<b>4,26</b>	P1X6,0X50-50	<b>3,81</b>
1,2X6,5	50	P1,2X6,5X50-2	<b>4,90</b>	P1,2X6,5X50-5	<b>4,26</b>	P1,2X6,5X50-50	<b>3,81</b>
1,2X8,0	50	P1,2X8,0X50-2	<b>4,90</b>	P1,2X8,0X50-5	<b>4,26</b>	P1,2X8,0X50-50	<b>3,81</b>

\*Fino ad esaurimento scorte

**INSERTI INTERCAMBIABILI PER AVVITATORE**

 50mm  
 LUNG.  
 TOTALE  
 (L<sub>1</sub>)

**TORX**

€ x Insetto		2 U.		5 U.		50 U.	
	L1 mm		€		€		€
T 5	50	PT5X50-2	<b>6,28</b>	PT5X50-5	<b>5,47</b>	PT5X50-50	<b>4,95</b>
T 6	50	PT6X50-2	<b>6,28</b>	PT6X50-5	<b>5,47</b>	PT6X50-50	<b>4,95</b>
T 7	50	PT7X50-2	<b>6,28</b>	PT7X50-5	<b>5,47</b>	PT7X50-50	<b>4,95</b>
T 8	50	PT8X50-2	<b>6,28</b>	PT8X50-5	<b>5,47</b>	PT8X50-50	<b>4,95</b>
T 9	50	PT9X50-2	<b>6,28</b>	PT9X50-5	<b>5,47</b>	PT9X50-50	<b>4,95</b>
T 10	50	PT10X50-2	<b>5,79</b>	PT10X50-5	<b>5,03</b>	PT10X50-50	<b>4,53</b>
T 15	50	PT15X50-2	<b>5,79</b>	PT15X50-5	<b>5,03</b>	PT15X50-50	<b>4,53</b>
T 20	50	PT20X50-2	<b>5,79</b>	PT20X50-5	<b>5,03</b>	PT20X50-50	<b>4,53</b>
T 25	50	PT25X50-2	<b>5,79</b>	PT25X50-5	<b>5,03</b>	PT25X50-50	<b>4,53</b>
T 27	50	PT27X50-2	<b>5,79</b>	PT27X50-5	<b>5,03</b>	PT27X50-50	<b>4,53</b>
T 30	50	PT30X50-2	<b>5,79</b>	PT30X50-5	<b>5,03</b>	PT30X50-50	<b>4,53</b>
T 40	50	PT40X50-2	<b>5,79</b>	PT40X50-5	<b>5,03</b>	PT40X50-50	<b>4,53</b>

**TESTA QUADRA  
ROBERTSON**

€ x Insetto		2 U.		5 U.		50 U.	
	L1 mm		€		€		€
N°1	50	PC1X50-2	<b>7,54</b>	PC1X50-5	<b>6,56</b>	PC1X50-50	<b>5,91</b>
N°2	50	PC2X50-2	<b>7,54</b>	PC2X50-5	<b>6,56</b>	PC2X50-50	<b>5,91</b>
N°3	50	PC3X50-2	<b>7,54</b>	PC3X50-5	<b>6,56</b>	PC3X50-50	<b>5,91</b>

**ESAGONALE**

€ x Insetto		2 U.		5 U.		50 U.	
	L1 mm		€		€		€
2 mm	50	PHX2X50-2	<b>6,11</b>	PHX2X50-5	<b>5,31</b>	PHX2X50-50	<b>4,78</b>
2,5 mm	50	PHX2,5X50-2	<b>6,11</b>	PHX2,5X50-5	<b>5,31</b>	PHX2,5X50-50	<b>4,78</b>
3 mm	50	PHX3X50-2	<b>6,11</b>	PHX3X50-5	<b>5,31</b>	PHX3X50-50	<b>4,78</b>
4 mm	50	PHX4X50-2	<b>6,11</b>	PHX4X50-5	<b>5,31</b>	PHX4X50-50	<b>4,78</b>
5 mm	50	PHX5X50-2	<b>6,11</b>	PHX5X50-5	<b>5,31</b>	PHX5X50-50	<b>4,78</b>
6 mm	50	PHX6X50-2	<b>6,11</b>	PHX6X50-5	<b>5,31</b>	PHX6X50-50	<b>4,78</b>
8 mm	50	PHX8X50-2	<b>7,82</b>	PHX8X50-5	<b>7,17</b>	PHX8X50-50	<b>6,13</b>

**INSERTI INTERCAMBIABILI PER AVVITATORE**



**70mm**  
LUNG.  
TOTALE  
(L<sub>1</sub>)



PHILLIPS



€ x Bit		2 Uds		5 Uds	
	L1 mm		€		€
Ph 1	70	Ph1X70-2	<b>7,37</b>	Ph1X70-5	<b>6,41</b>
Ph 2	70	Ph2X70-2	<b>7,37</b>	Ph2X70-5	<b>6,41</b>
Ph 3	70	Ph3X70-2	<b>7,37</b>	Ph3X70-5	<b>6,41</b>
Ph 4	70	Ph4X70-2	-	Ph4X70-5	-

POZIDRIV



€ x Bit		2 Uds		5 Uds	
	L1 mm		€		€
Pz 1	70	Pz1X70-2	<b>7,37</b>	Pz1X70-5	<b>6,41</b>
Pz 2	70	Pz2X70-2	<b>7,37</b>	Pz2X70-5	<b>6,41</b>
Pz 3	70	Pz3X70-2	<b>7,37</b>	Pz3X70-5	<b>6,41</b>
Pz 4	70	Pz4X70-2	-	Pz4X70-5	-



**90mm**  
LUNG.  
TOTALE  
(L<sub>1</sub>)



PHILLIPS



€ x Bit		2 Uds		5 Uds	
	L1 mm		€		€
Ph 1	90	Ph1X90-2	<b>9,09</b>	Ph1X90-5	<b>7,91</b>
Ph 2	90	Ph2X90-2	<b>9,09</b>	Ph2X90-5	<b>7,91</b>
Ph 3	90	Ph3X90-2	<b>9,09</b>	Ph3X90-5	<b>7,91</b>
Ph 4	90	Ph4X90-2	-	Ph4X90-5	-

POZIDRIV



€ x Bit		2 Uds		5 Uds	
	L1 mm		€		€
Pz 1	90	Pz1X90-2	<b>9,09</b>	Pz1X90-5	<b>7,91</b>
Pz 2	90	Pz2X90-2	<b>9,09</b>	Pz2X90-5	<b>7,91</b>
Pz 3	90	Pz3X90-2	<b>9,09</b>	Pz3X90-5	<b>7,91</b>
Pz 4	90	Pz4X90-2	-	Pz4X90-5	-

**INSERTI INTERCAMBIABILI PER AVVITATORE**
**TiN**

**25mm**  
 LUNG.  
 TOTALE  
 (L.)

**PHILLIPS**

€ x Insetto		2 U.		5 U.		50 U.	
	L1 mm		€		€		€
Ph 1	25	Ph1T-2	<b>3,71</b>	Ph1T-5	<b>2,80</b>	Ph1T-50	<b>2,52</b>
Ph 2	25	Ph2T-2	<b>3,71</b>	Ph2T-5	<b>2,80</b>	Ph2T-50	<b>2,52</b>
Ph 3	25	Ph3T-2	<b>3,71</b>	Ph3T-5	<b>2,80</b>	Ph3T-50	<b>2,52</b>

**POZIDRIV**

€ x Insetto		2 U.		5 U.		50 U.	
	L1 mm		€		€		€
Pz 1	25	Pz1T-2	<b>3,71</b>	Pz1T-5	<b>2,80</b>	Pz1T-50	<b>2,52</b>
Pz 2	25	Pz2T-2	<b>3,71</b>	Pz2T-5	<b>2,80</b>	Pz2T-50	<b>2,52</b>
Pz 3	25	Pz3T-2	<b>3,71</b>	Pz3T-5	<b>2,80</b>	Pz3T-50	<b>2,52</b>

**TESTA PIATTA**

€ x Insetto		2 U.		5 U.		50 U.	
	L1 mm		€		€		€
0,6X4,5	25	PO,6X4,5T-2	<b>3,97</b>	PO,6X4,5T-5	<b>3,45</b>	PO,6X4,5T-50	<b>3,10</b>
0,8X5,5	25	PO,8X5,5T-2	<b>3,97</b>	PO,8X5,5T-5	<b>3,45</b>	PO,8X5,5T-50	<b>3,10</b>
1,0X5,5	25	P1X5,5T-2	<b>3,97</b>	P1X5,5T-5	<b>3,45</b>	P1X5,5T-50	<b>3,10</b>
1,2X6,5	25	P1,2X6,5T-2	<b>3,97</b>	P1,2X6,5T-5	<b>3,45</b>	P1,2X6,5T-50	<b>3,10</b>

**TORX**

€ x Insetto		2 U.		5 U.		50 U.	
	L1 mm		€		€		€
T 10	25	PT10T-2	<b>4,02</b>	PT10T-5	<b>3,51</b>	PT10T-50	<b>3,15</b>
T 15	25	PT15T-2	<b>4,02</b>	PT15T-5	<b>3,51</b>	PT15T-50	<b>3,15</b>
T 20	25	PT20T-2	<b>4,02</b>	PT20T-5	<b>3,51</b>	PT20T-50	<b>3,15</b>
T 25	25	PT25T-2	<b>4,02</b>	PT25T-5	<b>3,51</b>	PT25T-50	<b>3,15</b>
T 27	25	PT27T-2	<b>4,02</b>	PT27T-5	<b>3,51</b>	PT27T-50	<b>3,15</b>
T 30	25	PT30T-2	<b>4,02</b>	PT30T-5	<b>3,51</b>	PT30T-50	<b>3,15</b>
T 40	25	PT40T-2	<b>4,02</b>	PT40T-5	<b>3,51</b>	PT40T-50	<b>3,15</b>



**INSERTI INTERCAMBIABILI PER AVVITATORE**

**TiN**



**50mm**  
LUNG.  
TOTALE  
(L<sub>1</sub>)



**PHILLIPS**



€ x Insetto		2 U.		5 U.		50 U.	
	L1 mm		€		€		€
Ph 1	50	Ph1Tx50-2	<b>8,56</b>	Ph1Tx50-5	<b>7,44</b>	Ph1Tx50-50	<b>6,67</b>
Ph 2	50	Ph2Tx50-2	<b>8,56</b>	Ph2Tx50-5	<b>7,44</b>	Ph2Tx50-50	<b>6,67</b>
Ph 3	50	Ph3Tx50-2	<b>8,56</b>	Ph3Tx50-5	<b>7,44</b>	Ph3Tx50-50	<b>6,67</b>

**POZIDRIV**



€ x Insetto		2 U.		5 U.		50 U.	
	L1 mm		€		€		€
Pz 1	50	Pz1Tx50-2	<b>8,56</b>	Pz1Tx50-5	<b>7,44</b>	Pz1Tx50-50	<b>6,67</b>
Pz 2	50	Pz2Tx50-2	<b>8,56</b>	Pz2Tx50-5	<b>7,44</b>	Pz2Tx50-50	<b>6,67</b>
Pz 3	50	Pz3Tx50-2	<b>8,56</b>	Pz3Tx50-5	<b>7,44</b>	Pz3Tx50-50	<b>6,67</b>

**TORX**



€ x Insetto		2 U.		5 U.		50 U.	
	L1 mm		€		€		€
T 10	50	PT10Tx50-2	<b>12,13</b>	PT10Tx50-5	<b>10,54</b>	PT10Tx50-50	<b>9,48</b>
T 15	50	PT15Tx50-2	<b>12,13</b>	PT15Tx50-5	<b>10,54</b>	PT15Tx50-50	<b>9,48</b>
T 20	50	PT20Tx50-2	<b>12,13</b>	PT20Tx50-5	<b>10,54</b>	PT20Tx50-50	<b>9,48</b>
T 25	50	PT25Tx50-2	<b>12,13</b>	PT25Tx50-5	<b>10,54</b>	PT25Tx50-50	<b>9,48</b>
T 27	50	PT27Tx50-2	<b>12,13</b>	PT27Tx50-5	<b>10,54</b>	PT27Tx50-50	<b>9,48</b>
T 30	50	PT30Tx50-2	<b>12,13</b>	PT30Tx50-5	<b>10,54</b>	PT30Tx50-50	<b>9,48</b>
T 40	50	PT40Tx50-2	<b>12,13</b>	PT40Tx50-5	<b>10,54</b>	PT40Tx50-50	<b>9,48</b>

**PORTAINSERI MAGNETICI**
**PORTAINSERI MAGNETICI**

	L1 mm	TIPO DI CODOLO	€
PMGx51	51	MAGNETICO SENZA ANELLO	6,94
PMGx58	58	MAGNETICO SENZA ANELLO	7,12
PMGx74	74	MAGNETICO CON ANELLO	12,54
PMGx100	100	MAGNETICO CON ANELLO	14,48
PMGx150	150	MAGNETICO CON ANELLO	16,01
PMGx200	200	MAGNETICO CON ANELLO	19,09
PMGx250	250	MAGNETICO CON ANELLO	29,36
PMGSDSx78	78	SDS PLUS	25,94
PBERx74	74	BERILIO	53,84*
PDESSx70	70	5/16" DESSOUTTER	33,17*
P7x74	74	7mm Fein	36,04*

\*Fino ad esaurimento scorte

**PORTAINSERI MAGNETICO A CAMBIO RAPIDO (ADATTO PER INSERTE DI 1/4" CON COLLO)**

	L1 mm	TIPO DI CODOLO	€
PCR60	60	Cambio rapido 1/4" Adatto per inserti di 1/4" con collo	18,65
PCR74	74	Cambio rapido 1/4" Adatto per inserti di 1/4" con collo	19,22
PCRSDSX80	80	SDS PLUS	37,81

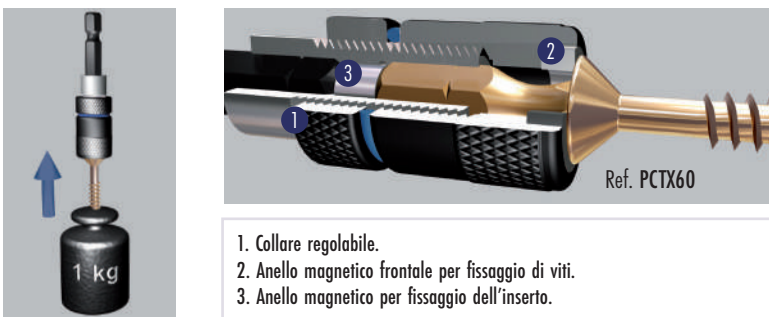
**PORTAINSERI MAGNETICO CON ANELLO MAGNETICO FRONTALE SUPPLEMENTARE PER FISSAGGIO DI VITI**

	L1 mm	TIPO DI CODOLO	€
PCTX60	60	Portainseri con collare regolabile	17,57



### BUSSOLE MAGNETICHE ESAGONALI

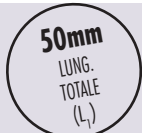

#### BUSSOLE MAGNETICHE ESAGONALI



	mm	"		€/ 10.
PLIHX5-2	5,0		2	6,85
PLIHX5,5-2	5,5		2	6,85
PLIHX6-2	6,0		2	6,85
PLIHX1/4-2		1/4"=6,35	2	6,85
PLIHX7-2	7,0		2	7,00
PLIHX5/16-2		5/16"=7,93	2	7,00
PLIHX8-2	8,0		2	7,00
PLIHX3/8-2		3/8"=9,52	2	7,00
PLIHX10-2	10,0		2	7,16
PLIHX11-2	11,0		2	7,16
PLIHX12-2	12,0		2	7,16
PLIHX13-2	13,0		2	7,16

#### SET DI 7 PEZZI DI BUSSOLE MAGNETICHE ESAGONALI

REFERENZA	EPLL
N° PEZZI	7
CONTENUTO	HX1/4 - HX7 - HX8 - HX3/8 HX10 - HX12 - HX13
P.V.P. €	49,34



#### GIRAVITE A CRICCHETTO CON STOCCAGGIO DI INSERTE ED ESPOSITORE PER GIRAVITI



- Alta qualità e rendimento.
- Rotazione a destra e a sinistra.
- Telescopico regolabile in lunghezza.
- Fabbricato in acciaio e plastica ad alta resistenza.

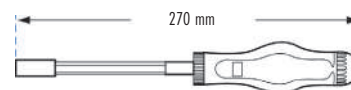
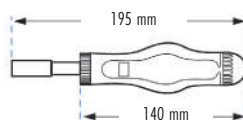

#### DTRC

- Contenuto del giravite
- PH1 - PH2
  - PZ1 - PZ2
  - T15 - T20 - T25 - T30

37,49 €

### SET DI INSERTE INTERCAMBIABILI PER AVVITATORE

#### SET DI 7 PEZZI QUALITÀ PLUS E TITANIO



Ref. EPT1

REFERENZA	EPT1	EPT2	EPT3
N° PEZZI	7	7	7
CONTENUTO	PH1 - PH2 PZ1 - PZ2 0,8x5,5 - 1,2x6,5 1 Portainseriti PMG	T10 - T15 T20 - T25 T30 - T40 1 Portainseriti PMG	PH1 - PH2 - PH3 PZ1 - PZ2 - PZ3 1 Portainseriti PMG
P.V.P. €	13,03	17,58	15,63



Ref. EPTT1

REFERENZA	EPTT1	EPTT2	EPTT3
N° PEZZI	7	7	7
CONTENUTO	PH1 - PH2 PZ1 - PZ2 0,8x5,5 - 1,2x6,5 1 Portainseriti PMG	T10 - T15 T20 - T25 T30 - T40 1 Portainseriti PMG	PH1 - PH2 - PH3 PZ1 - PZ2 - PZ3 1 Portainseriti PMG
P.V.P. €	37,00	42,90	35,67

**SET DI INSERTI INTERCAMBIABILI PER AVVITATORE**
**SET DI 12 PEZZI QUALITÀ PLUS E TiN**

Ref. EPT4

REFERENZA

N° PEZZI

CONTENUTO



P.V.P. €

**EPT4**

12

+ PH1 - PH2(2) - PH3  
 + PZ1 - PZ2(2) - PZ3  
 - 0,6x4,5 - 0,8x5,5 - 1,2x6,5  
 1Portainseriti PMG

**17,48****EPT5**

12

☆ T10 - T15(2)  
 ☆ T20(2) - T25(2)  
 T27 - T30(2) - T40  
 1Portainseriti PMG

**24,01**

Ref. EPTT4

REFERENZA

N° PEZZI

CONTENUTO



P.V.P. €

**EPTT4**

12

+ PH1 - PH2(2) - PH3  
 + PZ1 - PZ2(2) - PZ3  
 - 0,6x4,5 - 0,8x5,5 - 1,2x6,5  
 1Portainseriti PCT

**46,58****EPTT5**

12

T10 - T15(2)  
 ☆ T20(2) - T25(2)  
 T27 - T30(2) - T40  
 1Portainseriti PCT

**54,81**
**SET DI 31 PEZZI QUALITÀ PLUS E TiN**

Ref. EPT6

REFERENZA

N° PEZZI

CONTENUTO



P.V.P. €

**EPT6**

31

+ PH1(3) - PH2(3) - PH3(3)  
 + PZ1(3) - PZ2(3) - PZ3(3)  
 - 0,6x4,5 - 0,8x5,5 - 1,2x6,5  
 ☆ T10 - T15 - T20 - T25 - T30 - T40  
 ○ H3 - H4 - H5  
 1Portainseriti PMG

**50,00**

REFERENZA

N° PEZZI

CONTENUTO



P.V.P. €

**EPTT6**

31

+ PH1(3) - PH2(3) - PH3(3)  
 + PZ1(3) - PZ2(3) - PZ3(3)  
 - 0,6x4,5 - 0,8x5,5 - 1,2x6,5  
 ☆ T10 - T15 - T20 - T25 - T30 - T40  
 ○ H3 - H4 - H5  
 1Portainseriti PCT

**106,07**
**SET DI 36 PEZZI QUALITÀ PLUS E TiN**

Ref. EPT7

REFERENZA

N° PEZZI

CONTENUTO



P.V.P. €

**EPT7**

36

+ PH1(3) - PH2(3) - PH3(3)  
 + PZ1(3) - PZ2(3) - PZ3(3)  
 - 0,5 x 4 - 0,6 x 4,5 - 0,8 x 5 - 0,8 x 5,5 - 1 x 6 - 1,2 x 6,5 - 1,2 x 8  
 ☆ T10 - T15 - T20 - T25 - T27 - T30 - T40  
 ○ H2 - H2,5 - H3 - H4 - H5 - H6 - H8  
 1Portainseriti PMG

**63,30**

Ref. EPTT7

REFERENZA

N° PEZZI

CONTENUTO



P.V.P. €

**EPTT7\***

36

+ PH1(3) - PH2(3) - PH3(3)  
 + PZ1(3) - PZ2(3) - PZ3(3)  
 - 0,5 x 4 - 0,6 x 4,5 - 0,8 x 5 - 0,8 x 5,5 - 1 x 6 - 1,2 x 6,5 - 1,2 x 8  
 ☆ T10 - T15 - T20 - T25 - T27 - T30 - T40  
 ○ H2 - H2,5 - H3 - H4 - H5 - H6 - H8  
 1Portainseriti PCT

**129,90\***

\*Fino ad esaurimento scorte

**SET DI INSERTI INTERCAMBIABILI PER AVVITATORE**

SET DI 45 E 80 PEZZI QUALITÀ *Plus*



Ref. EPT45



Ref. EPT80



REFERENZA	EPT45	
N° PEZZI	45	
CONTENUTO	<ul style="list-style-type: none"> <li> PH1(2) - PH2(2) - PH3(2)</li> <li> PZ1(2) - PZ2(2) - PZ3(2)</li> <li> 0,5x3-0,6x4,5-0,8x5,5(2)-1,2x6,5-1,6x8</li> <li> H2,5 - H3 - H4 - H5 - H6 - H7</li> <li> T10 - T15 - T20 - T25 - T30 - T40</li> </ul>	<ul style="list-style-type: none"> <li> Chiavi di bussola esagonali (mm): 5 - 6 - 7 - 8 - 9 - 10 - 11 - 12 - 13 - 14</li> <li> 1 Adattatore per bussola</li> <li> 1 Adattatore per inserti</li> <li> 1 Portainseri Magnetico PCR</li> <li> 1 Chiave a cricchetto con 72 denti</li> <li> 1 Giravite</li> </ul>
P.V.P. €	<b>158,41</b>	



REFERENZA	EPT80*	
N° PEZZI	80	
CONTENUTO	<ul style="list-style-type: none"> <li> PH0 - PH1 - PH2(4) - PH3(2)</li> <li> PZ1 - PZ2(4) - PZ3(2)</li> <li> 0,5x3-0,6x4,5-0,8x5,5(2)-1,2x6,5-1,6x8</li> <li> H2 - H2,5 - H3 - H4 - H5 - H6 - H7 - H8</li> <li> TW1 - TW2 - TW3 - TW4 - TW5</li> <li> TQ5 - TQ6 - TQ8 - TQ10</li> <li> T5 - T6 - T7 - T8 - T9 - T10 - T15 T20(2) - T25(2) - T27 - T30 - T40</li> <li> TS10 - TS15 - TS20 - TS25 - TS30 - TS40</li> </ul>	<ul style="list-style-type: none"> <li> C0 - C1 - C2 - C3</li> <li> SP4 - SP6 - SP8 - SP10</li> <li> HS3 - HS4 - HS5 - HS6</li> <li> 1 Portainseri Magnetico PCR</li> <li> 1 Giravite</li> <li> PH1 - PH2</li> <li> PZ1 - PZ2</li> <li> T15 - T20 - T25 - T30</li> </ul>
P.V.P. €	<b>155,24*</b>	

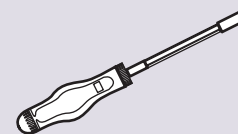

\*Fino ad esaurimento scorte

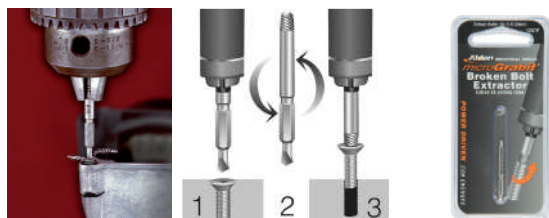
**ESTRATTORI A MACCHINA PER VITI ROTTE**
**MICRO GRABIT**

		EP
		€
EP451C	M3	55,10
EP452C	M4	55,10
EP453C	M5	55,10
EP454C	M6	55,10

1. Perforare la vite.
2. Girare.
3. Estrarre.

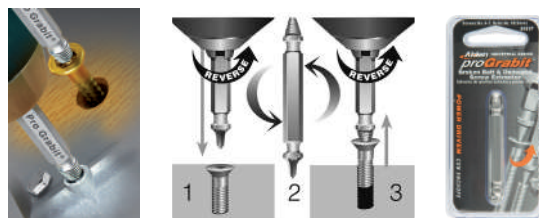
**PRO GRABIT CON CORPO ESAGONALE 1/4"**

		EP
		€
EP8401C	M5	43,70
EP8402C	M6	51,63
EP8403C	M8	51,63
EP8404C	M10	54,18

1. Perforare la vite.
2. Girare.
3. Estrarre.

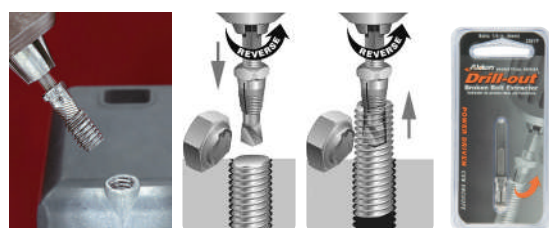
**DRILL-OUT ESTRATTORE DI VITI ROTTE CON PUNTA PILOTA (M6-M12)**

		EP
		€
EP205C	M6	53,42
EP312C	M8	64,73
EP375C	M10	64,73
EP500C	M12	72,86

**X-OUT ESTRATTORE DI VITI ROTTE CON CODOLO ESAGONALE (M3-M5)**

		EP
		€
EP3701C	M3	43,70
EP3702C	M4	43,70
EP3703C	M5	48,57

**SERIE DI ESTRATTORI A MACCHINA PER VITI ROTTE**

REFERENCIA	EP450C
Nº PIEZAS	4
CONTENIDO	M3-M4-M5-M6
P.V.P. €	226,00



REFERENCIA	EP401C
Nº PIEZAS	4
CONTENIDO	M6-M8-M10-M12
P.V.P. €	265,87



**ESTRATTORI A MANO LAMINATI PER VITI ROTTE**

**SERIE DI ESTRATTORI CLASSICI PER VITI**

Realizzare un foro centrale con la punta Blue-Master raccomandata; introdurre l'estrattore nel foro, girare l'estrattore verso sinistra fino ad estrarre la vite.

REFERENZA	EX/1-5	EX/1-6	EX/1-8
N° PEZZI	5	6	8
CONTENUTO	M3 - M18	M3 - M24	M3 - M45
P.V.P. €	<b>22,96</b>	<b>31,07</b>	<b>71,73</b>

Ref. EX/1-6



	Per VITI	mm	mm	L1 mm	Ø min mm	Ø max. mm	EX €
EX/1	M3 - M6	3,2	2,5	51	1,75	3,95	<b>3,06</b>
EX/2	M6 - M8	4,0	3,0	60	2,20	4,80	<b>3,06</b>
EX/3	M8 - M11	5,1	4,5	68	3,30	6,40	<b>3,60</b>
EX/4	M11 - M14	6,2	6,0	76	4,75	8,40	<b>4,47</b>
EX/5	M14 - M18	8,6	8,0	86	6,35	11,00	<b>5,82</b>
EX/6	M18 - M24	12,0	11,0	95	9,50	15,00	<b>9,82</b>
EX/7	M24 - M33	15,9	14,0	105	12,70	19,00	<b>26,63</b>
EX/8	M33 - M45	20,0	21,0	111	19,00	25,00	<b>43,60</b>

REFERENZA	EXTT
N° PEZZI	10
ESTRATTORI PUNTE PRECEDENTI	EX/1-EX/2-EX/3-EX/4-EX/5 Ref. BC3 Ø2,5-3-4,5-6-8
P.V.P. €	<b>40,87</b>



**ESTRATTORI A MANO PER VITI ROTTE**



	Per VITI	mm	mm	L1 mm	Ø min mm	Ø max. mm	EFX €
EFX/1	M3-M6	2,9	2,0	50	1,9	3,2	<b>3,85</b>
EFX/2	M6-M8	3,9	3,2	60	2,8	5,0	<b>3,85</b>
EFX/3	M8-M11	4,8	4,0	68	3,2	6,5	<b>4,56</b>
EFX/4	M11-M14	6,7	6,4	75	5,2	9,0	<b>5,67</b>
EFX/5	M14-M18	8,5	7,1	85	6,4	11,0	<b>7,35</b>
EFX/6	M18-M25	11,8	9,5	95	9,4	15,0	<b>12,43</b>
EFX/7	M25-M35	14,3	12,7	106	12,8	19,0	<b>33,68</b>
EFX/8	M35-M45	19,5	19,5	110	19,3	25,0	<b>55,17</b>

Ref. EFX/1-5



REFERENZA	EFX/1-5
N° PEZZI	5
CONTENUTO	M3 - M18
P.V.P. €	<b>29,49</b>

**PUNTE PER METALLO EXTRA CORTE**

Ref. BH2

HSS



OX



	Ø mm	L1 x L2 mm	mm	BH2 €
BH20200	2,00	61 x 33	1/4"	<b>6,00</b>
BH20300	3,00	61 x 33	1/4"	<b>6,00</b>
BH20400	4,00	75 x 43	1/4"	<b>6,95</b>
BH20500	5,00	86 x 52	1/4"	<b>8,64</b>
BH20600	6,00	93 x 57	1/4"	<b>9,32</b>
BH20700	7,00	109 x 69	1/4"	<b>11,74</b>
BH20800	8,00	117 x 75	1/4"	<b>13,19</b>
BH20900	9,00	125 x 81	1/4"	<b>14,84</b>
BH21000	10,00	133 x 87	1/4"	<b>16,51</b>



REFERENZA	BH29335	BH29333
N° PUNTE	5	8
QUALITÀ	HSS	HSS
CONTENUTO	Ø 3-4-5-6-8 mm	Ø 3-4-5-6-7-8-9-10 mm
P.V.P. €	<b>53,15</b>	<b>71,10</b>

**UTENSILI A CODOLO ESAGONALE 1/4"**
**PUNTA PER METALLO EXTRA CORTA**
**HSS-G**

Ref. BC59

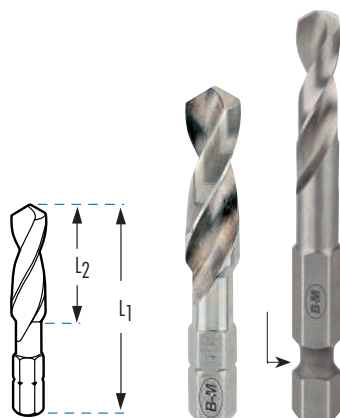
**PUNTE-MASCHI SVASATORI**
**HSS-G**

Ref. MAHM

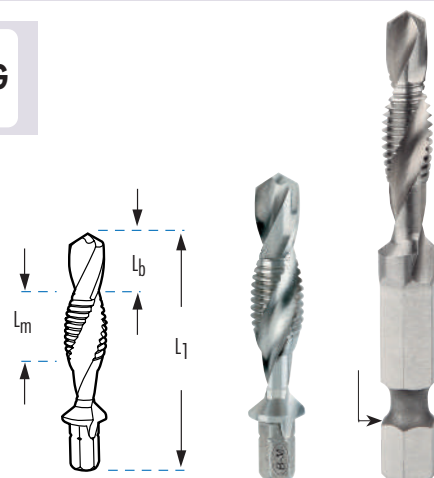

				BC59	BC59CR
	Ø mm	L1 x L2 mm		€	€
BC590100	1,00	34 x 12	1/4"	7,21	-
BC590150	1,50	34 x 12	1/4"	7,21	-
BC590200	2,00	34 x 12	1/4"	7,21	7,21
BC590250	2,50	36 x 14	1/4"	7,21	7,21
BC590300	3,00	38 x 16	1/4"	7,21	7,21
BC590330	3,30	40 x 18	1/4"	7,21	7,21
BC590350	3,50	40 x 18	1/4"	7,21	7,21
BC590400	4,00	44 x 20	1/4"	7,21	7,21
BC590420	4,20	45 x 20	1/4"	7,21	7,21
BC590450	4,50	46 x 24	1/4"	7,21	7,21
BC590500	5,00	50 x 26	1/4"	7,21	7,21
BC590550	5,50	50 x 26	1/4"	7,53	7,53
BC590600	6,00	50 x 26	1/4"	7,53	7,53
BC590650	6,50	50 x 30	1/4"	7,53	7,53
BC590680	6,80	50 x 30	1/4"	7,53	7,53
BC590700	7,00	50 x 30	1/4"	7,53	7,53
BC590750	7,50	51 x 32	1/4"	8,80	8,80
BC590800	8,00	51 x 32	1/4"	8,80	8,80
BC590850	8,50	53 x 33	1/4"	8,80	8,80
BC590900	9,00	53 x 33	1/4"	10,14	10,14
BC590950	9,50	54 x 38	1/4"	10,14	10,14
BC591000	10,00	54 x 38	1/4"	10,14	10,14
BC591020	10,20	54 x 38	1/4"	10,14	10,14

			MAHM	MAHMCR	
	L1 x Lb x Lm mm		€	€	
	M 3 x 0,50	36 x 5 x 6	1/4"	20,36	20,36
	M 4 x 0,70	39 x 6 x 7	1/4"	20,36	20,36
	M 5 x 0,80	41 x 8 x 8	1/4"	20,36	20,36
	M 6 x 1,00	44 x 8 x 10	1/4"	20,36	20,36
	M 8 x 1,25	50 x 10 x 11	1/4"	28,16	28,16
	M 10 x 1,50	59 x 11 x 11	1/4"	33,96	33,96



REFERENZA	<b>MAH9327CR</b>
N° PUNTE	5
REFERENZA PUNTE	MAHMCR
CONTENUTO	M4-M5-M6-M8-M10
P.V.P. €	143,56

**MASCHI HSS-G**
**HSS-G**

Ref. M

			M	MCR	
	L1 x L2 mm		€	€	
	M 3 x 0,50	33 x 11	1/4"	7,59	7,59
	M 4 x 0,70	35 x 12	1/4"	7,59	7,59
	M 5 x 0,80	36 x 15	1/4"	9,65	9,65
	M 6 x 1,00	39 x 18	1/4"	9,65	9,65
	M 8 x 1,25	40 x 19	1/4"	13,38	13,38
	M 10 x 1,50	41 x 21	1/4"	16,53	16,53

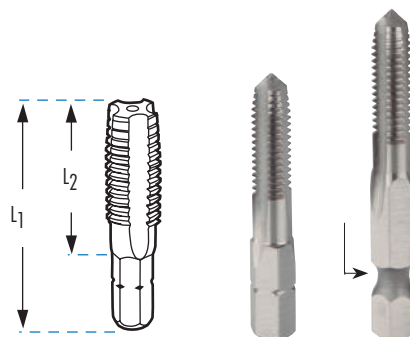



**UTENSILI A CODOLO ESAGONALE 1/4"**

**BROCA MACHO HSSCo STEP CUT**

**NEW**

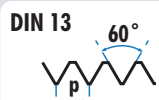

**HSSCo**  
5%

**BRILLANTE**

**TOL**  
6H

**D**  
CODOLO  
SOTTILE



Ref. MTKM

**STEP CUT**

										MTKM	
										€	
M	3x0,50	D	7,0	6,0	6,0	57,0	2,5	2,2	7,3	1/4"	23,41
M	4x0,70	D	7,0	8,5	6,0	62,0	3,3	3,0	7,3	1/4"	23,41
M	5x0,80	D	9,0	10,0	6,0	69,0	4,2	3,7	7,3	1/4"	23,41
M	6x1,00	D	10,0	12,0	6,0	73,0	5,0	4,5	7,3	1/4"	23,41
M	8x1,25	D	12,0	16,0	6,0	87,0	6,8	6,3	9,4	1/4"	32,39
M	10x1,50	D	14,0	20,0	6,0	96,0	8,5	8,0	11,4	1/4"	39,05
M	12x1,75	D	16,0	24,0	8,0	112,0	10,3	9,8	13,4	1/4"	56,36

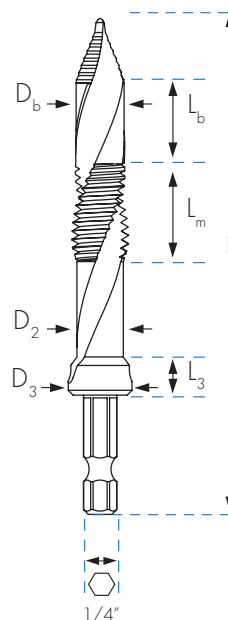

**SVASATORE A 3 TAGLIANTI**

**HSS-G**

Ref. AV22

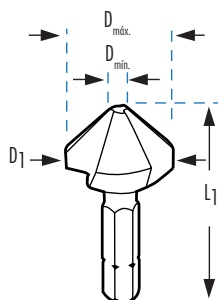

AV22				
D1 mm	L1 mm	D min. -D max. mm		€
6,30	31	1,50 - 5,8	1/4"	19,05
8,30	31	2,00 - 7,8	1/4"	19,05
10,40	34	2,50 - 10,0	1/4"	20,43
12,40	35	2,80 - 12,0	1/4"	21,80
16,50	40	3,20 - 16,0	1/4"	24,38
20,50	41	3,50 - 20,0	1/4"	26,78

**SVASATORE A SBAVARE**

**HSS**



Ref. AV1...CR



Ref. AV101CR  
Ref. AV102CR

Ref. AV103CR  
Ref. AV104CR

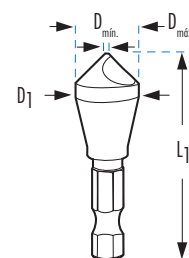

AV1...CR					
	D1 mm	L1 mm	D min. -D max. mm		€
AV101CR	10,00	40	2,0 - 5,0	1/4"	19,32
AV102CR	14,00	42	5,0 - 10,0	1/4"	24,14
AV103CR	17,00	45	5,0 - 13,0	1/4"	43,25
AV104CR	25,00	55	7,0 - 20,0	1/4"	77,25

**UTENSILI A CODOLO ESAGONALE 1/4"**
**PUNTA PER MURO**

Ref. BWH

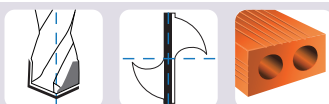
**PUNTA PER LEGNO**

Ref. BMH

CV



BWH				
	Ø mm	L1 x L2 mm		€
BWH03	3	70 x 30	1/4"	3,39
BWH04	4	70 x 30	1/4"	3,66
BWH05	5	85 x 45	1/4"	3,97
BWH06	6	100 x 50	1/4"	4,42
BWH07	7	100 x 50	1/4"	5,19
BWH08	8	120 x 70	1/4"	6,00
BWH09	9	120 x 70	1/4"	7,18
BWH10	10	120 x 70	1/4"	8,03
BWH11	11	150 x 80	1/4"	10,01
BWH12	12	150 x 80	1/4"	11,31
BWH13	13	150 x 80	1/4"	13,90
BWH14	14	150 x 80	1/4"	16,19

BMH				
	Ø mm	L1 x L2 mm		€
BMH03	3	59 x 35	1/4"	2,15
BMH04	4	74 x 41	1/4"	2,28
BMH05	5	82 x 55	1/4"	2,26
BMH06	6	88 x 58	1/4"	3,03
BMH07	7	110 x 70	1/4"	3,44
BMH08	8	110 x 70	1/4"	3,58
BMH09	9	110 x 70	1/4"	3,73
BMH10	10	115 x 75	1/4"	4,14
BMH11	11	135 x 85	1/4"	4,83
BMH12	12	135 x 85	1/4"	5,65
BMH13	13	135 x 90	1/4"	8,85
BMH14	14	145 x 95	1/4"	11,03



REFERENZA	BWH9318	BWH9327	BWH9319	BMH9335	BMH9333
N° PUNTE	5	5	8	5	8
APLICACIÓN	MURO	MURO	MURO	LEGNO	LEGNO
CONTENUTO	Ø 3 - 4 - 5 - 6 - 8 mm	Ø 4 - 5 - 6 - 8 - 10 mm	Ø 3 - 4 - 5 - 6 - 7 - 8 - 9 - 10 mm	Ø 3 - 4 - 5 - 6 - 8 mm	Ø 3 - 4 - 5 - 6 - 7 - 8 - 9 - 10 mm
P.V.P. €	28,58	34,48	39,47	17,73	23,38

**ASSORTIMENTI DI UTENSILI A CODOLO ESAGONALE 1/4"**

Ref. EB



Ref. EMBP

**CONTENUTO**

	HSS-G	HSS-G			€
EM	M3 - M4 - M5 - M6 M8 - M10	-	-	-	62,66
EMBP	M3 - M4 - M5 - M6 M8 - M10	Ø 2,50 - 3,30 - 4,20 5 - 6,80 - 8,50	-	-	101,30
EBM	-	-	M3 - M4 - M5 - M6 M8 - M10	-	132,69
EA	-	-	-	Ø 6,30 - 8,30 - 10,40 12,40 - 16,50 - 20,50	127,97
EB	-	Ø 1 - 10 mm x 0,50	-	-	140,34