

BLUE-MASTER[®]
by *celesa*



PUNTAS
DE ATORNILLAR

PUNTAS INTERCAMBIABLES DE ATORNILLAR
Plus

25mm
 LONG.
 TOTAL
 (L₁)

PHILLIPS

€ x Punta	L1 mm	2 Uds		5 Uds		50 Uds		100 Uds	
			€		€		€		€
Ph 0	25	Ph0-2	1,55	Ph0-5	1,36	Ph0-50	1,21	Ph0-100	1,16
Ph 1	25	Ph1-2	1,30	Ph1-5	0,81	Ph1-50	0,73	Ph1-100	0,68
Ph 2	25	Ph2-2	1,30	Ph2-5	0,81	Ph2-50	0,73	Ph2-100	0,68
Ph 3	25	Ph3-2	1,30	Ph3-5	0,81	Ph3-50	0,73	Ph3-100	0,68

POZIDRIV

€ x Punta	L1 mm	2 Uds		5 Uds		50 Uds		100 Uds	
			€		€		€		€
Pz 0	25	Pz0-2	1,55	Pz0-5	1,36	Pz0-50	1,21	Pz0-100	1,16
Pz 1	25	Pz1-2	1,30	Pz1-5	0,81	Pz1-50	0,73	Pz1-100	0,68
Pz 2	25	Pz2-2	1,30	Pz2-5	0,81	Pz2-50	0,73	Pz2-100	0,68
Pz 3	25	Pz3-2	1,30	Pz3-5	0,81	Pz3-50	0,73	Pz3-100	0,68

RANURA

€ x Punta	L1 mm	2 Uds		5 Uds		50 Uds		100 Uds	
			€		€		€		€
0,5X3,0	25	P0,5X3,0-2	1,76	P0,5X3,0-5	1,52	P0,5X3,0-50	1,38	P0,5X3,0-100	1,31
0,6X3,5	25	P0,6X3,5-2	1,76	P0,6X3,5-5	1,52	P0,6X3,5-50	1,38	P0,6X3,5-100	1,31
0,5X4,0	25	P0,5X4,0-2	1,76	P0,5X4,0-5	1,52	P0,5X4,0-50	1,38	P0,5X4,0-100	1,31
0,6X4,5	25	P0,6X4,5-2	1,76	P0,6X4,5-5	1,52	P0,6X4,5-50	1,38	P0,6X4,5-100	1,31
0,8X4,0	25	P0,8X4,0-2	1,76	P0,8X4,0-5	1,52	P0,8X4,0-50	1,38	P0,8X4,0-100	1,31
0,8X5,0	25	P0,8X5,0-2	1,76	P0,8X5,0-5	1,52	P0,8X5,0-50	1,38	P0,8X5,0-100	1,31
0,8X5,5	25	P0,8X5,5-2	1,76	P0,8X5,5-5	1,52	P0,8X5,5-50	1,38	P0,8X5,5-100	1,31
1,0X5,5	25	P1X5,5-2	1,76	P1X5,5-5	1,52	P1X5,5-50	1,38	P1X5,5-100	1,31
1,0X6,0	25	P1X6,0-2	1,76	P1X6,0-5	1,52	P1X6,0-50	1,38	P1X6,0-100	1,31
1,2X6,5	25	P1,2X6,5-2	1,76	P1,2X6,5-5	1,52	P1,2X6,5-50	1,38	P1,2X6,5-100	1,31
1,2X8,0	25	P1,2X8,0-2	1,76	P1,2X8,0-5	1,52	P1,2X8,0-50	1,38	P1,2X8,0-100	1,31

PUNTAS INTERCAMBIABLES DE ATORNILLAR



Plus

★★

25mm
LONG.
TOTAL
(L₁)

TORX



€ x Punta		2 Uds		5 Uds		50 Uds		100 Uds	
	L1 mm		€		€		€		€
T5	25	PT5-2	2,32	PT5-5	2,01	PT5-50	1,82	PT5-100	1,72
T6	25	PT6-2	2,32	PT6-5	2,01	PT6-50	1,82	PT6-100	1,72
T7	25	PT7-2	2,32	PT7-5	2,01	PT7-50	1,82	PT7-100	1,72
T8	25	PT8-2	2,32	PT8-5	2,01	PT8-50	1,82	PT8-100	1,72
T9	25	PT9-2	2,32	PT9-5	2,01	PT9-50	1,82	PT9-100	1,72
T10	25	PT10-2	1,91	PT10-5	1,49	PT10-50	1,33	PT10-100	1,26
T15	25	PT15-2	1,91	PT15-5	1,49	PT15-50	1,33	PT15-100	1,26
T20	25	PT20-2	1,91	PT20-5	1,49	PT20-50	1,33	PT20-100	1,26
T25	25	PT25-2	1,91	PT25-5	1,49	PT25-50	1,33	PT25-100	1,26
T27	25	PT27-2	1,91	PT27-5	1,49	PT27-50	1,33	PT27-100	1,26
T30	25	PT30-2	1,91	PT30-5	1,49	PT30-50	1,33	PT30-100	1,26
T40	25	PT40-2	1,91	PT40-5	1,49	PT40-50	1,33	PT40-100	1,26

TORX REDONDA



€ x Punta		2 Uds		5 Uds		50 Uds		100 Uds	
	L1 mm		€		€		€		€
TR10	25	PTR10-2	6,17	PTR10-5	5,36	PTR10-50	4,84	PTR10-100	4,55
TR15	25	PTR15-2	6,17	PTR15-5	5,36	PTR15-50	4,84	PTR15-100	4,55
TR20	25	PTR20-2	6,17	PTR20-5	5,36	PTR20-50	4,84	PTR20-100	4,55
TR25	25	PTR25-2	6,17	PTR25-5	5,36	PTR25-50	4,84	PTR25-100	4,55
TR30	25	PTR30-2	6,17	PTR30-5	5,36	PTR30-50	4,84	PTR30-100	4,55
TR40	25	PTR40-2	6,17	PTR40-5	5,36	PTR40-50	4,84	PTR40-100	4,55

CUADRADO ROBERTSON



€ x Punta		2 Uds		5 Uds		50 Uds		100 Uds	
	L1 mm		€		€		€		€
Nº1	25	PC1-2	2,48	PC1-5	2,17	PC1-50	1,95	PC1-100	1,84
Nº2	25	PC2-2	2,48	PC2-5	2,17	PC2-50	1,95	PC2-100	1,84
Nº3	25	PC3-2	2,48	PC3-5	2,17	PC3-50	1,95	PC3-100	1,84

PUNTAS INTERCAMBIABLES DE ATORNILLAR
Plus

25mm
 LONG.
 TOTAL
 (L)

**TORX DE
 SEGURIDAD**

€ x Punta		2 Uds		5 Uds		50 Uds		100 Uds	
	L1 mm		€		€		€		€
TS10	25	PTS10-2	3,31	PTS10-5	2,87	PTS10-50	2,59	PTS10-100	2,44
TS15	25	PTS15-2	3,31	PTS15-5	2,87	PTS15-50	2,59	PTS15-100	2,44
TS20	25	PTS20-2	3,31	PTS20-5	2,87	PTS20-50	2,59	PTS20-100	2,44
TS25	25	PTS25-2	3,31	PTS25-5	2,87	PTS25-50	2,59	PTS25-100	2,44
TS27	25	PTS27-2	3,31	PTS27-5	2,87	PTS27-50	2,59	PTS27-100	2,44
TS30	25	PTS30-2	3,31	PTS30-5	2,87	PTS30-50	2,59	PTS30-100	2,44
TS40	25	PTS40-2	3,31	PTS40-5	2,87	PTS40-50	2,59	PTS40-100	2,44

**CABEZA
 HEXAGONAL**

€ x Punta		2 Uds		5 Uds		50 Uds		100 Uds	
	L1 mm		€		€		€		€
2 mm	25	PHX2-2	1,83	PHX2-5	1,66	PHX2-50	1,48	PHX2-100	1,42
2,5 mm	25	PHX2,5-2	1,83	PHX2,5-5	1,66	PHX2,5-50	1,48	PHX2,5-100	1,42
3 mm	25	PHX3-2	1,83	PHX3-5	1,66	PHX3-50	1,48	PHX3-100	1,42
4 mm	25	PHX4-2	1,83	PHX4-5	1,66	PHX4-50	1,48	PHX4-100	1,42
5 mm	25	PHX5-2	1,83	PHX5-5	1,66	PHX5-50	1,48	PHX5-100	1,42
6 mm	25	PHX6-2	1,83	PHX6-5	1,66	PHX6-50	1,48	PHX6-100	1,42
8 mm	25	PHX8-2	2,17	PHX8-5	1,97	PHX8-50	1,90	PHX8-100	1,79

**TRI
 WING**

€ x Punta		2 Uds		5 Uds		50 Uds		100 Uds	
	L1 mm		€		€		€		€
Nº4	25	PTRW4-2	10,92	PTRW4-5	9,50	PTRW4-50	8,55	PTRW4-100	8,08
Nº5	25	PTRW5-2	10,92	PTRW5-5	9,50	PTRW5-50	8,55	PTRW5-100	8,08
Nº6	25	PTRW6-2	10,92	PTRW6-5	9,50	PTRW6-50	8,55	PTRW6-100	8,08
Nº8	25	PTRW8-2	10,92	PTRW8-5	9,50	PTRW8-50	8,55	PTRW8-100	8,08

XZN

€ x Punta		2 Uds		5 Uds		50 Uds		100 Uds	
	L1 mm		€		€		€		€
Nº4	25	PXZN4-2	6,69	PXZN4-5	5,83	PXZN4-50	5,24	PXZN4-100	4,95
Nº5	25	PXZN5-2	6,69	PXZN5-5	5,83	PXZN5-50	5,24	PXZN5-100	4,95
Nº6	25	PXZN6-2	6,69	PXZN6-5	5,83	PXZN6-50	5,24	PXZN6-100	4,95
Nº8	25	PXZN8-2	7,51	PXZN8-5	6,53	PXZN8-50	6,41	PXZN8-100	6,29
Nº10	25	PXZN10-2	7,51	PXZN10-5	6,53	PXZN10-50	6,41	PXZN10-100	6,29

PUNTAS INTERCAMBIABLES DE ATORNILLAR



50mm
LONG.
TOTAL
(L₁)

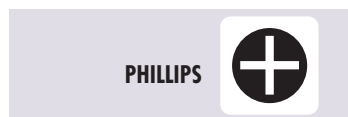

€ x Punta		2 Uds		5 Uds		50 Uds	
	L1 mm		€		€		€
Ph 1	50	Ph1X50-2	2,97	Ph1X50-5	2,59	Ph1X50-50	2,33
Ph 2	50	Ph2X50-2	2,97	Ph2X50-5	2,59	Ph2X50-50	2,33
Ph 3	50	Ph3X50-2	2,97	Ph3X50-5	2,59	Ph3X50-50	2,33
Ph 4	50	Ph4X50-2	-	Ph4X50-5	-	Ph4X50-50	-

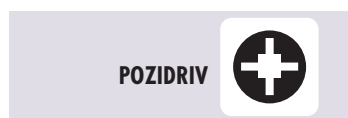

€ x Punta		2 Uds		5 Uds		50 Uds	
	L1 mm		€		€		€
Pz 1	50	Pz1X50-2	2,97	Pz1X50-5	2,59	Pz1X50-50	2,33
Pz 2	50	Pz2X50-2	2,97	Pz2X50-5	2,59	Pz2X50-50	2,33
Pz 3	50	Pz3X50-2	2,97	Pz3X50-5	2,59	Pz3X50-50	2,33
Pz 4	50	Pz4X50-2	-	Pz4X50-5	-	Pz4X50-50	-

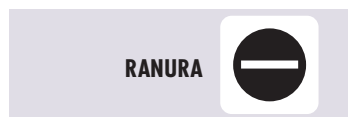

€ x Punta		2 Uds		5 Uds		50 Uds	
	L1 mm		€		€		€
0,5X4,0	50	P0,5X4,0X50-2	4,69	P0,5X4,0X50-5	4,06	P0,5X4,0X50-50	3,64
0,5X3,0	50	P0,5X3,0X50-2	4,69	P0,5X3,0X50-5	4,06	P0,5X3,0X50-50	3,64
0,6X3,5	50	P0,6X3,5X50-2	4,69	P0,6X3,5X50-5	4,06	P0,6X3,5X50-50	3,64
0,6X4,5	50	P0,6X4,5X50-2	4,69	P0,6X4,5X50-5	4,06	P0,6X4,5X50-50	3,64
0,8X4,0	50	P0,8X4,0X50-2	4,69	P0,8X4,0X50-5	4,06	P0,8X4,0X50-50	3,64
0,8X5,0	50	P0,8X5,0X50-2	4,69*	P0,8X5,0X50-5	4,06*	P0,8X5,0X50-50	3,64*
0,8X5,5	50	P0,8X5,5X50-2	4,69	P0,8X5,5X50-5	4,06	P0,8X5,5X50-50	3,64
1,0X5,5	50	P1X5,5X50-2	4,69	P1X5,5X50-5	4,06	P1X5,5X50-50	3,64
1,0X6,0	50	P1X6,0X50-2	4,69	P1X6,0X50-5	4,06	P1X6,0X50-50	3,64
1,2X6,5	50	P1,2X6,5X50-2	4,69	P1,2X6,5X50-5	4,06	P1,2X6,5X50-50	3,64
1,2X8,0	50	P1,2X8,0X50-2	4,69	P1,2X8,0X50-5	4,06	P1,2X8,0X50-50	3,64

*Hasta fin de existencias

PUNTAS INTERCAMBIABLES DE ATORNILLAR

50mm
LONG.
TOTAL
(L₁)

TORX

€ x Punta		2 Uds		5 Uds		50 Uds	
	L1 mm		€		€		€
T 5	50	PT5X50-2	6,00	PT5X50-5	4,57	PT5X50-50	4,23
T 6	50	PT6X50-2	6,00	PT6X50-5	4,57	PT6X50-50	4,23
T 7	50	PT7X50-2	6,00	PT7X50-5	4,57	PT7X50-50	4,23
T 8	50	PT8X50-2	6,00	PT8X50-5	4,57	PT8X50-50	4,23
T 9	50	PT9X50-2	6,00	PT9X50-5	4,57	PT9X50-50	4,23
T 10	50	PT10X50-2	5,52	PT10X50-5	4,30	PT10X50-50	3,87
T 15	50	PT15X50-2	5,52	PT15X50-5	4,30	PT15X50-50	3,87
T 20	50	PT20X50-2	5,52	PT20X50-5	4,30	PT20X50-50	3,87
T 25	50	PT25X50-2	5,52	PT25X50-5	4,30	PT25X50-50	3,87
T 27	50	PT27X50-2	5,52	PT27X50-5	4,30	PT27X50-50	3,87
T 30	50	PT30X50-2	5,52	PT30X50-5	4,30	PT30X50-50	3,87
T 40	50	PT40X50-2	5,52	PT40X50-5	4,30	PT40X50-50	3,87





**CUADRADO
ROBERTSON**

€ x Punta		2 Uds		5 Uds		50 Uds	
	L1 mm		€		€		€
Nº1	50	PC1X50-2	7,20	PC1X50-5	6,26	PC1X50-50	5,64
Nº2	50	PC2X50-2	7,20	PC2X50-5	6,26	PC2X50-50	5,64
Nº3	50	PC3X50-2	7,20	PC3X50-5	6,26	PC3X50-50	5,64

HEXAGONAL

€ x Punta		2 Uds		5 Uds		50 Uds	
	L1 mm		€		€		€
2 mm	50	PHX2X50-2	5,83	PHX2X50-5	5,07	PHX2X50-50	4,56
2,5 mm	50	PHX2,5X50-2	5,83	PHX2,5X50-5	5,07	PHX2,5X50-50	4,56
3 mm	50	PHX3X50-2	5,83	PHX3X50-5	5,07	PHX3X50-50	4,56
4 mm	50	PHX4X50-2	5,83	PHX4X50-5	5,07	PHX4X50-50	4,56
5 mm	50	PHX5X50-2	5,83	PHX5X50-5	5,07	PHX5X50-50	4,56
6 mm	50	PHX6X50-2	5,83	PHX6X50-5	5,07	PHX6X50-50	4,56
8 mm	50	PHX8X50-2	7,47	PHX8X50-5	6,84	PHX8X50-50	5,85

PUNTAS INTERCAMBIABLES DE ATORNILLAR

PHILLIPS 



€ x Punta		2 Uds		5 Uds	
	L1 mm		€		€
Ph 1	70	Ph1X70-2	6,97	Ph1X70-5	6,07
Ph 2	70	Ph2X70-2	6,97	Ph2X70-5	6,07
Ph 3	70	Ph3X70-2	6,97	Ph3X70-5	6,07
Ph 4	70	Ph4X70-2	-	Ph4X70-5	-

POZIDRIV 



€ x Punta		2 Uds		5 Uds	
	L1 mm		€		€
Pz 1	70	Pz1X70-2	7,04	Pz1X70-5	6,12
Pz 2	70	Pz2X70-2	7,04	Pz2X70-5	6,12
Pz 3	70	Pz3X70-2	7,04	Pz3X70-5	6,12
Pz 4	70	Pz4X70-2	-	Pz4X70-5	-







PHILLIPS 



€ x Punta		2 Uds		5 Uds	
	L1 mm		€		€
Ph 1	90	Ph1X90-2	8,59	Ph1X90-5	7,48
Ph 2	90	Ph2X90-2	8,59	Ph2X90-5	7,48
Ph 3	90	Ph3X90-2	8,59	Ph3X90-5	7,48
Ph 4	90	Ph4X90-2	-	Ph4X90-5	-

POZIDRIV 



€ x Punta		2 Uds		5 Uds	
	L1 mm		€		€
Pz 1	90	Pz1X90-2	8,67	Pz1X90-5	7,55
Pz 2	90	Pz2X90-2	8,67	Pz2X90-5	7,55
Pz 3	90	Pz3X90-2	8,67	Pz3X90-5	7,55
Pz 4	90	Pz4X90-2	-	Pz4X90-5	-

PUNTAS INTERCAMBIABLES DE ATORNILLAR
TiN

25mm
 LONG.
 TOTAL
 (L.)

PHILLIPS

€ x Punta		2 Uds		5 Uds		50 Uds	
	L1 mm		€		€		€
Ph 1	25	Ph1T-2	3,51	Ph1T-5	2,65	Ph1T-50	2,38
Ph 2	25	Ph2T-2	3,51	Ph2T-5	2,65	Ph2T-50	2,38
Ph 3	25	Ph3T-2	3,51	Ph3T-5	2,65	Ph3T-50	2,38

POZIDRIV

€ x Punta		2 Uds		5 Uds		50 Uds	
	L1 mm		€		€		€
Pz 1	25	Pz1T-2	3,54	Pz1T-5	2,67	Pz1T-50	2,41
Pz 2	25	Pz2T-2	3,54	Pz2T-5	2,67	Pz2T-50	2,41
Pz 3	25	Pz3T-2	3,54	Pz3T-5	2,67	Pz3T-50	2,41

RANURA



€ x Punta		2 Uds		5 Uds		50 Uds	
	L1 mm		€		€		€
0,6X4,5	25	PO,6X4,5T-2	3,80	PO,6X4,5T-5	3,29	PO,6X4,5T-50	2,96
0,8X5,5	25	PO,8X5,5T-2	3,80	PO,8X5,5T-5	3,29	PO,8X5,5T-50	2,96
1,0X5,5	25	P1X5,5T-2	3,80	P1X5,5T-5	3,29	P1X5,5T-50	2,96
1,2X6,5	25	P1,2X6,5T-2	3,80	P1,2X6,5T-5	3,29	P1,2X6,5T-50	2,96

TORX

€ x Punta		2 Uds		5 Uds		50 Uds	
	L1 mm		€		€		€
T 10	25	PT10T-2	3,65	PT10T-5	3,28	PT10T-50	2,87
T 15	25	PT15T-2	3,65	PT15T-5	3,28	PT15T-50	2,87
T 20	25	PT20T-2	3,65	PT20T-5	3,28	PT20T-50	2,87
T 25	25	PT25T-2	3,65	PT25T-5	3,28	PT25T-50	2,87
T 27	25	PT27T-2	3,65	PT27T-5	3,28	PT27T-50	2,87
T 30	25	PT30T-2	3,65	PT30T-5	3,28	PT30T-50	2,87
T 40	25	PT40T-2	3,65	PT40T-5	3,28	PT40T-50	2,87

PUNTAS INTERCAMBIABLES DE ATORNILLAR

TiN  **50mm LONG. TOTAL (L)**



PHILLIPS 



€ x Punta		2 Uds		5 Uds		50 Uds	
	L1 mm		€		€		€
Ph 1	50	Ph1Tx50-2	8,09	Ph1Tx50-5	7,03	Ph1Tx50-50	6,31
Ph 2	50	Ph2Tx50-2	8,09	Ph2Tx50-5	7,03	Ph2Tx50-50	6,31
Ph 3	50	Ph3Tx50-2	8,09	Ph3Tx50-5	7,03	Ph3Tx50-50	6,31

POZIDRIV 



€ x Punta		2 Uds		5 Uds		50 Uds	
	L1 mm		€		€		€
Pz 1	50	Pz1Tx50-2	8,17	Pz1Tx50-5	7,10	Pz1Tx50-50	6,37
Pz 2	50	Pz2Tx50-2	8,17	Pz2Tx50-5	7,10	Pz2Tx50-50	6,37
Pz 3	50	Pz3Tx50-2	8,17	Pz3Tx50-5	7,10	Pz3Tx50-50	6,37

TORX 



€ x Punta		2 Uds		5 Uds		50 Uds	
	L1 mm		€		€		€
T 10	50	PT10Tx50-2	11,57	PT10Tx50-5	10,06	PT10Tx50-50	9,05
T 15	50	PT15Tx50-2	11,57	PT15Tx50-5	10,06	PT15Tx50-50	9,05
T 20	50	PT20Tx50-2	11,57	PT20Tx50-5	10,06	PT20Tx50-50	9,05
T 25	50	PT25Tx50-2	11,57	PT25Tx50-5	10,06	PT25Tx50-50	9,05
T 27	50	PT27Tx50-2	11,57	PT27Tx50-5	10,06	PT27Tx50-50	9,05
T 30	50	PT30Tx50-2	11,57	PT30Tx50-5	10,06	PT30Tx50-50	9,05
T 40	50	PT40Tx50-2	11,57	PT40Tx50-5	10,06	PT40Tx50-50	9,05

PORTAPUNTAS MAGNÉTICOS

PORTAPUNTAS MAGNÉTICOS

	L1 mm	TIPO DE MANGO	€
PMGx51	51	MAGNÉTICO SIN ANILLO	6,99
PMGx58	58	MAGNÉTICO SIN ANILLO	7,26
PMGx74	74	MAGNÉTICO CON ANILLO	11,97
PMGx100	100	MAGNÉTICO CON ANILLO	14,48
PMGx150	150	MAGNÉTICO CON ANILLO	16,13
PMGx200	200	MAGNÉTICO CON ANILLO	19,09
PMGx250	250	MAGNÉTICO CON ANILLO	29,36
PMGSDSx78	78	SDS PLUS	20,03
PBERx74	74	BERILIO	51,40*
PDESSx70	70	5/16" DESSOUTTER	31,67*
P7x74	74	7mm Fein	34,40*

*Hasta fin de existencias



PORTAPUNTAS MAGNÉTICO CON CAMBIO RÁPIDO (APTO PARA PUNTAS DE 1/4" CON CUELLO)

	L1 mm	TIPO DE MANGO	€
PCR60	60	Cambio rápido 1/4" Apto para puntas de 1/4" con cuello	17,81
PCR74	74	Cambio rápido 1/4" Apto para puntas de 1/4" con cuello	18,34
PCRSDSX80	80	SDS PLUS	29,21



PORTAPUNTAS MAGNÉTICO CON ANILLO MAGNÉTICO FRONTAL ADICIONAL PARA SUJECIÓN DE TORNILLOS

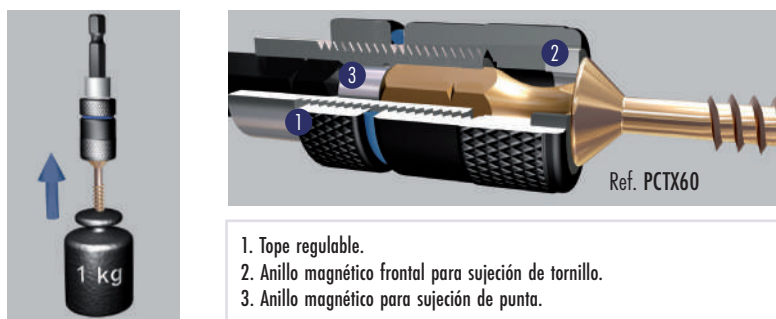

	L1 mm	TIPO DE MANGO	€
PCTX60	60	Portapuntas con tope regulable	16,77



VASOS MAGNÉTICOS HEXAGONALES



VASO HEXAGONAL MAGNÉTICO



	mm	"		€/ 10.
PLHX5-2	5,0		2	6,35
PLHX5,5-2	5,5		2	6,35
PLHX6-2	6,0		2	6,35
PLHX1/4-2		1/4"=6,35	2	6,35
PLHX7-2	7,0		2	6,49
PLHX5/16-2		5/16"=7,93	2	6,49
PLHX8-2	8,0		2	6,49
PLHX3/8-2		3/8"=9,52	2	6,49
PLHX10-2	10,0		2	6,65
PLHX11-2	11,0		2	6,84
PLHX12-2	12,0		2	6,90
PLHX13-2	13,0		2	7,23

ESTUCHES DE 7 PIEZAS DE VASOS MAGNÉTICOS HEXAGONALES

REFERENCIA	EPLL
Nº LLAVES	7
CONTENIDO	HX1/4 - HX7 - HX8 - HX3/8 HX10 - HX12 - HX13
P.V.P. €	47,09



DESTORNILLADOR DE CARRACA CON ALMACÉN DE PUNTAS Y EXPOSITOR PARA DESTORNILLADORES

Plus

1. Alta calidad y rendimiento
2. Giro a derechas y a izquierdas
3. Caña telescópica ajustable en longitud
4. Fabricado en acero y plástico de alta resistencia

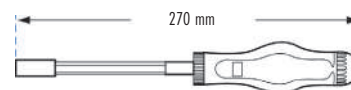
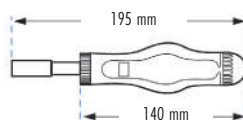

DTRC

- Contenido del destornillador
- PH1 - PH2
 - PZ1 - PZ2
 - T15 - T20 - T25 - T30

35,77 €

ESTUCHES DE PUNTAS INTERCAMBIABLES DE ATORNILLAR

ESTUCHES DE 7 PIEZAS CALIDAD PLUS Y TiN



Ref. EPT1



















REFERENCIA	EPT1	EPT2	EPT3
Nº PIEZAS	7	7	7
CONTENIDO	PH1 - PH2 PZ1 - PZ2 - 0,8x5,5 - 1,2x6,5 1 Portapuntas PMG	T10 - T15 T20 - T25 T30 - T40 1 Portapuntas PMG	PH1 - PH2 - PH3 PZ1 - PZ2 - PZ3 1 Portapuntas PMG
P.V.P. €	12,45	16,78	14,92



















Ref. EPTT1

REFERENCIA	EPTT1	EPTT2	EPTT3
Nº PIEZAS	7	7	7
CONTENIDO	PH1 - PH2 PZ1 - PZ2 - 0,8x5,5 - 1,2x6,5 1 Portapuntas PMG	T10 - T15 T20 - T25 T30 - T40 1 Portapuntas PMG	PH1 - PH2 - PH3 PZ1 - PZ2 - PZ3 1 Portapuntas PMG
P.V.P. €	35,31	40,95	34,04

















ESTUCHES DE PUNTAS INTERCAMBIABLES DE ATORNILLAR
ESTUCHES DE 12 PIEZAS CALIDAD PLUS Y TiN

		REFERENCIA	EPT4	EPT5
 Ref. EPT4	REFERENCIA			
	Nº PIEZAS		12	12
 Ref. EPT4	CONTENIDO	 <ul style="list-style-type: none">  PH1 - PH2(2) - PH3  PZ1 - PZ2(2) - PZ3  0,6x4,5 - 0,8x5,5 - 1,2x6,5 1 Portapuntas PMG	<ul style="list-style-type: none">  T10 - T15(2)  T20(2) - T25(2)  T27 - T30(2) - T40 1 Portapuntas PMG	
	P.V.P. €		16,70	22,93
 Ref. EPT4	REFERENCIA			
	Nº PIEZAS		12	12
 Ref. EPT4	CONTENIDO	 <ul style="list-style-type: none">  PH1 - PH2(2) - PH3  PZ1 - PZ2(2) - PZ3  0,6x4,5 - 0,8x5,5 - 1,2x6,5 1 Portapuntas PCT	<ul style="list-style-type: none">  T10 - T15(2)  T20(2) - T25(2)  T27 - T30(2) - T40 1 Portapuntas PCT	
	P.V.P. €		44,47	52,31

ESTUCHES DE 31 PIEZAS CALIDAD PLUS Y TiN

		REFERENCIA	EPT6	EPT6
 Ref. EPT6	REFERENCIA			
	Nº PIEZAS		31	31
 Ref. EPT6	CONTENIDO	 <ul style="list-style-type: none">  PH1(3) - PH2(3) - PH3(3)  PZ1(3) - PZ2(3) - PZ3(3)  0,6x4,5 - 0,8x5,5 - 1,2x6,5 	<ul style="list-style-type: none">  T10 - T15 - T20 - T25 - T30 - T40  H3 - H4 - H5 1 Portapuntas PMG	
	P.V.P. €		47,72	47,72
 Ref. EPT6	REFERENCIA			
	Nº PIEZAS		31	31
 Ref. EPT6	CONTENIDO	 <ul style="list-style-type: none">  PH1(3) - PH2(3) - PH3(3)  PZ1(3) - PZ2(3) - PZ3(3)  0,6x4,5 - 0,8x5,5 - 1,2x6,5 	<ul style="list-style-type: none">  T10 - T15 - T20 - T25 - T30 - T40  H3 - H4 - H5 1 Portapuntas PCT	
	P.V.P. €		101,25	101,25

ESTUCHES DE 36 PIEZAS CALIDAD PLUS Y TiN

		REFERENCIA	EPT7	EPT7
 Ref. EPT7	REFERENCIA			
	Nº PIEZAS		36	36
 Ref. EPT7	CONTENIDO	 <ul style="list-style-type: none">  PH1(3) - PH2(3) - PH3(3)  PZ1(3) - PZ2(3) - PZ3(3)  0,5 x 4 - 0,6 x 4,5 - 0,8 x 5 - 0,8 x 5,5 - 1 x 6 - 1,2 x 6,5 - 1,2 x 8 	<ul style="list-style-type: none">  T10 - T15 - T20 - T25 - T27 - T30 - T40  H2 - H2,5 - H3 - H4 - H5 - H6 - H8 1 Portapuntas PMG	
	P.V.P. €		60,43	60,43
 Ref. EPT7	REFERENCIA			
	Nº PIEZAS		36	36
 Ref. EPT7	CONTENIDO	 <ul style="list-style-type: none">  PH1(3) - PH2(3) - PH3(3)  PZ1(3) - PZ2(3) - PZ3(3)  0,5 x 4 - 0,6 x 4,5 - 0,8 x 5 - 0,8 x 5,5 - 1 x 6 - 1,2 x 6,5 - 1,2 x 8 	<ul style="list-style-type: none">  T10 - T15 - T20 - T25 - T27 - T30 - T40  H2 - H2,5 - H3 - H4 - H5 - H6 - H8 1 Portapuntas PCT	
	P.V.P. €		123,99*	123,99*

*Hasta fin de existencias

ESTUCHES DE PUNTAS INTERCAMBIABLES DE ATORNILLAR

ESTUCHES DE 45 Y 80 PIEZAS CALIDAD *Plus*



Ref. EPT45



Ref. EPT80



REFERENCIA	EPT45	
Nº PIEZAS	45	
CONTENIDO	<ul style="list-style-type: none"> PH1(2) - PH2(2) - PH3(2) PZ1(2) - PZ2(2) - PZ3(2) 0,5x3-0,6x4,5-0,8x5,5(2)-1,2x6,5-1,6x8 H2,5 - H3 - H4 - H5 - H6 - H7 T10 - T15 - T20 - T25 - T30 - T40 	<ul style="list-style-type: none"> Llaves de vasos Hexagonales (mm): 5 - 6 - 7 - 8 - 9 - 10 - 11 - 12 - 13 - 14 1 Adaptador de Vasos 1 Adaptador de Puntas 1 Portapuntas Magnético PCR 1 Llave de Carraca de 72 dientes 1 Destornillador
P.V.P. €	151,21	



REFERENCIA	EPT80*	
Nº PIEZAS	80	
CONTENIDO	<ul style="list-style-type: none"> PH0 - PH1 - PH2(4) - PH3(2) PZ1 - PZ2(4) - PZ3(2) 0,5x3-0,6x4,5-0,8x5,5(2)-1,2x6,5-1,6x8 H2 - H2,5 - H3 - H4 - H5 - H6 - H7 - H8 TW1 - TW2 - TW3 - TW4 - TW5 TQ5 - TQ6 - TQ8 - TQ10 T5 - T6 - T7 - T8 - T9 - T10 - T15 T20(2) - T25(2) - T27 - T30 - T40 TS10 - TS15 - TS20 - TS25 - TS30 - TS40 	<ul style="list-style-type: none"> C0 - C1 - C2 - C3 SP4 - SP6 - SP8 - SP10 HS3 - HS4 - HS5 - HS6 1 Portapuntas Magnético PCR 1 Destornillador PH1 - PH2 PZ1 - PZ2 T15 - T20 - T25 - T30
P.V.P. €	155,24*	

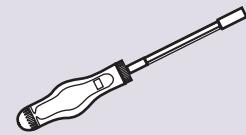

*Hasta fin de existencias

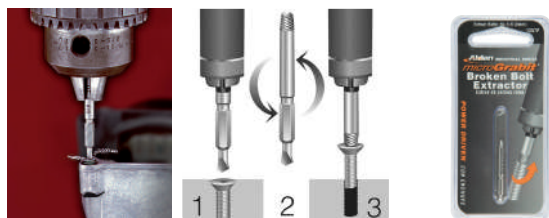
EXTRACTORES DE MÁQUINA PARA TORNILLOS ROTOS
MICRO GRABIT

		EP
		€
EP451C	M3	55,10
EP452C	M4	55,10
EP453C	M5	55,10
EP454C	M6	55,10

1. Taladrar el tornillo
2. Dar la vuelta.
3. Extraer

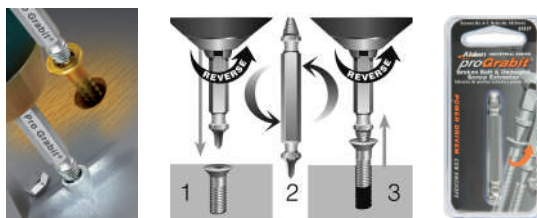
PRO GRABIT CON CUERPO HEXAGONAL 1/4"

		EP
		€
EP8401C	M5	43,70
EP8402C	M6	51,63
EP8403C	M8	51,63
EP8404C	M10	54,18

1. Taladrar el tornillo
2. Dar la vuelta.
3. Extraer

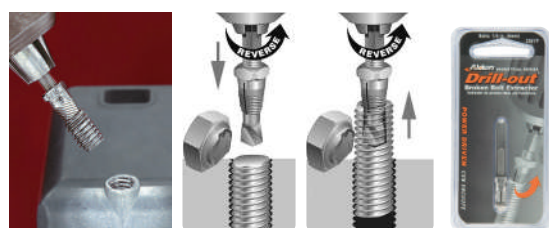
DRILL-OUT EXTRACTOR DE TORNILLOS ROTOS CON BROCA GUÍA (M6-M12)

		EP
		€
EP205C	M6	53,42
EP312C	M8	64,73
EP375C	M10	64,73
EP500C	M12	72,86

X-OUT EXTRACTOR DE TORNILLOS ROTOS CON MANGO HEXAGONAL (M3-M5)

		EP
		€
EP3701C	M3	43,70
EP3702C	M4	43,70
EP3703C	M5	48,57

ESTUCHES DE EXTRACTORES DE MÁQUINA PARA TORNILLOS ROTOS
MICRO GRABIT

DRILL-OUT

REFERENCIA	EP450C
Nº PIEZAS	4
CONTENIDO	M3-M4-M5-M6
P.V.P. €	226,00

REFERENCIA	EP401C
Nº PIEZAS	4
CONTENIDO	M6-M8-M10-M12
P.V.P. €	265,87

EXTRACTORES DE MANO LAMINADOS PARA TORNILLOS ROTOS

JUEGOS DE EXTRACTORES CLÁSICOS DE TORNILLOS

Taladrar un agujero central con la broca Blue-Master recomendada; Introducir el extractor en el agujero, haciendo girar el extractor hacia la izquierda, hasta extraer el tornillo.

REFERENCIA	EX/1-5	EX/1-6	EX/1-8
Nº PIEZAS	5	6	8
CONTENIDO	M3 - M18	M3 - M24	M3 - M45
P.V.P. €	23,38	31,64	73,03

Ref. EX/1-6



	Para TORNILLOS	mm	mm	L1 mm	Ø min mm	Ø max. mm	EX €
EX/1	M3 - M6	3,2	2,5	51	1,75	3,95	2,90
EX/2	M6 - M8	4,0	3,0	60	2,20	4,80	2,90
EX/3	M8 - M11	5,1	4,5	68	3,30	6,40	3,44
EX/4	M11 - M14	6,2	6,0	76	4,75	8,40	4,26
EX/5	M14 - M18	8,6	8,0	86	6,35	11,00	5,54
EX/6	M18 - M24	12,0	11,0	95	9,50	15,00	9,38
EX/7	M24 - M33	15,9	14,0	105	12,70	19,00	25,40
EX/8	M33 - M45	20,0	21,0	111	19,00	25,00	41,61

REFERENCIA	EXTT
Nº PIEZAS	10
EXTRACTORES	EX/1-EX/2-EX/3-EX/4-EX/5
BROCAS PREVIAS	Ref. BC3 Ø2,5-3-4,5-6-8
P.V.P. €	39,01

EXTRACTORES DE MANO FRESADOS PARA TORNILLOS ROTOS



	Para TORNILLOS	mm	mm	L1 mm	Ø min mm	Ø max. mm	EFX €
EFX/1	M3-M6	2,9	2,0	50	1,9	3,2	3,69
EFX/2	M6-M8	3,9	3,2	60	2,8	5,0	3,69
EFX/3	M8-M11	4,8	4,0	68	3,2	6,5	4,35
EFX/4	M11-M14	6,7	6,4	75	5,2	9,0	5,40
EFX/5	M14-M18	8,5	7,1	85	6,4	11,0	7,00
EFX/6	M18-M25	11,8	9,5	95	9,4	15,0	11,88
EFX/7	M25-M35	14,3	12,7	106	12,8	19,0	32,16
EFX/8	M35-M45	19,5	19,5	110	19,3	25,0	52,67

Ref. EFX/1-5



REFERENCIA	EFX/1-5
Nº PIEZAS	5
CONTENIDO	M3 - M18
P.V.P. €	28,16

BROCA PARA METAL DIN 338

Ref. BH2

HSS



OX



	Ø mm	L1 x L2 mm	mm	BH2 €
BH20200	2,00	61 x 33	1/4"	7,52
BH20300	3,00	61 x 33	1/4"	7,69
BH20400	4,00	75 x 43	1/4"	8,14
BH20500	5,00	86 x 52	1/4"	10,12
BH20600	6,00	93 x 57	1/4"	10,93
BH20700	7,00	109 x 69	1/4"	13,78
BH20800	8,00	117 x 75	1/4"	15,47
BH20900	9,00	125 x 81	1/4"	17,40
BH21000	10,00	133 x 87	1/4"	19,38



REFERENCIA	BH29335	BH29333
Nº BROCAS	5	8
CALIDAD	HSS	HSS
CONTENIDO	Ø 3-4-5-6-8 mm	Ø 3-4-5-6-7-8-9-10 mm
P.V.P. €	53,15	71,10

HERRAMIENTAS CON MANGO HEXAGONAL 1/4"
BROCA PARA METAL EXTRA CORTA CON Y SIN CUELLO
HSS-G

Ref. BC59

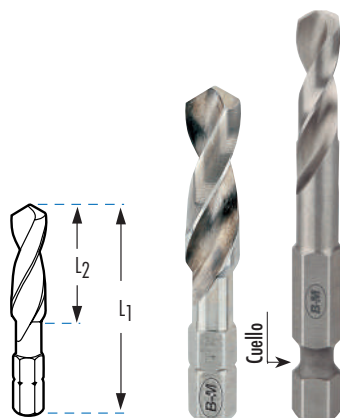
BROCA-MACHO AVELLANADOR
HSS-G

Ref. MAHM

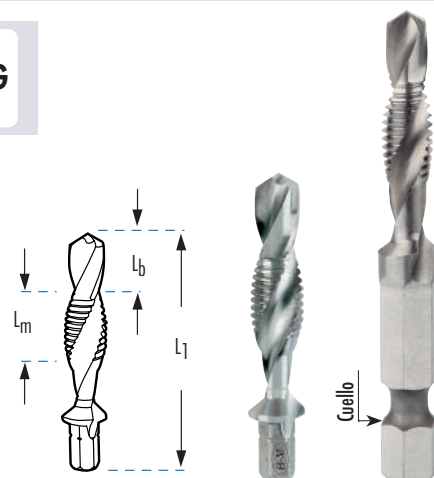

				BC59	BC59CR
	Ø mm	L1 x L2 mm		€	€
BC590100	1,00	34 x 12	1/4"	7,52	-
BC590150	1,50	34 x 12	1/4"	7,52	-
BC590200	2,00	34 x 12	1/4"	7,52	7,52
BC590250	2,50	36 x 14	1/4"	7,52	7,52
BC590300	3,00	38 x 16	1/4"	7,52	7,52
BC590330	3,30	40 x 18	1/4"	7,52	7,52
BC590350	3,50	40 x 18	1/4"	7,52	7,52
BC590400	4,00	44 x 20	1/4"	7,52	7,52
BC590420	4,20	45 x 20	1/4"	7,52	7,52
BC590450	4,50	46 x 24	1/4"	7,52	7,52
BC590500	5,00	50 x 26	1/4"	7,52	7,52
BC590550	5,50	50 x 26	1/4"	8,21	8,21
BC590600	6,00	50 x 26	1/4"	8,21	8,21
BC590650	6,50	50 x 30	1/4"	8,21	8,21
BC590680	6,80	50 x 30	1/4"	8,21	8,21
BC590700	7,00	50 x 30	1/4"	8,21	8,21
BC590750	7,50	51 x 32	1/4"	9,29	9,29
BC590800	8,00	51 x 32	1/4"	9,29	9,29
BC590850	8,50	53 x 33	1/4"	9,29	9,29
BC590900	9,00	53 x 33	1/4"	11,21	11,21
BC590950	9,50	54 x 38	1/4"	11,21	11,21
BC591000	10,00	54 x 38	1/4"	11,21	11,21
BC591020	10,20	54 x 38	1/4"	11,21	11,21

			MAHM	MAHMCRCR	
	L1 x Lb x Lm mm		€	€	
	M 3 x 0,50	36 x 5 x 6	1/4"	24,53	24,53
	M 4 x 0,70	39 x 6 x 7	1/4"	24,53	24,53
	M 5 x 0,80	41 x 8 x 8	1/4"	25,60	25,60
	M 6 x 1,00	44 x 8 x 10	1/4"	26,66	26,66
	M 8 x 1,25	50 x 10 x 11	1/4"	36,86	36,86
	M 10 x 1,50	59 x 11 x 11	1/4"	44,47	44,47



REFERENCIA	MAH9327CR
Nº BROCAS	5
REFERENCIA BROCAS	MAHMCRCR
CONTENIDO	M4-M5-M6-M8-M10
P.V.P. €	182,64

MACHO HSS-G
HSS-G

Ref. M

			M	MCR	
	L1 x L2 mm		€	€	
	M 3 x 0,50	33 x 11	1/4"	8,90	8,90
	M 4 x 0,70	35 x 12	1/4"	8,90	8,90
	M 5 x 0,80	36 x 15	1/4"	11,34	11,34
	M 6 x 1,00	39 x 18	1/4"	11,34	11,34
	M 8 x 1,25	40 x 19	1/4"	15,70	15,70
	M 10 x 1,50	41 x 21	1/4"	19,39	19,39

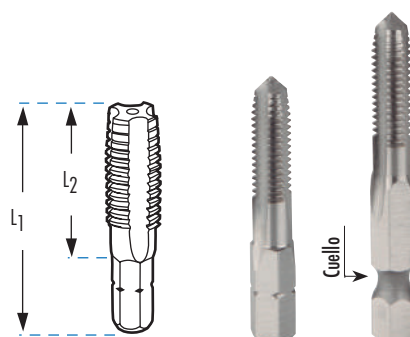

HERRAMIENTAS CON MANGO HEXAGONAL 1/4"

BROCA MACHO HSSCo STEP CUT

NEW

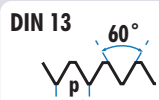

HSSCo
5%

BRILLANTE

TOL
6H

D
MANGO
DELGADO



Ref. MTKM

STEP CUT

										MTKM
		Lb	Lm	L3	L	Db	D2	D3		€
		mm	mm	mm	mm	mm	mm	mm	Hexagon	
M	3x0,50	D 7,0	6,0	6,0	57,0	2,5	2,2	7,3	1/4"	28,21
M	4x0,70	D 7,0	8,5	6,0	62,0	3,3	3,0	7,3	1/4"	28,21
M	5x0,80	D 9,0	10,0	6,0	69,0	4,2	3,7	7,3	1/4"	29,44
M	6x1,00	D 10,0	12,0	6,0	73,0	5,0	4,5	7,3	1/4"	30,66
M	8x1,25	D 12,0	16,0	6,0	87,0	6,8	6,3	9,4	1/4"	42,38
M	10x1,50	D 14,0	20,0	6,0	96,0	8,5	8,0	11,4	1/4"	51,14
M	12x1,75	D 16,0	24,0	8,0	112,0	10,3	9,8	13,4	1/4"	56,36

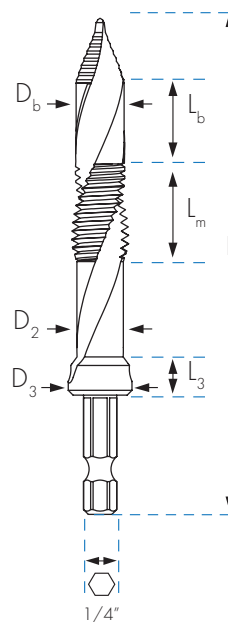

AVELLANADOR DE 3 CORTES

HSS-G

Ref. AV22

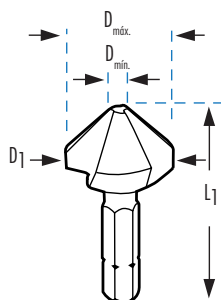

AVELLANADOR PARA DESBARBAR

HSS

Ref. AV1...CR



Ref. AV101CR
Ref. AV102CR

Ref. AV103CR
Ref. AV104CR

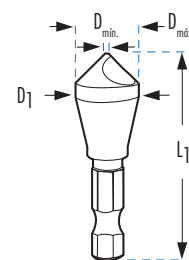

AV22				
D1	L1	D min. -D max.	Hexagon	€
mm	mm	mm	1/4"	
6,30	31	1,50 - 5,8	1/4"	22,65
8,30	31	2,00 - 7,8	1/4"	22,65
10,40	34	2,50 - 10,0	1/4"	24,27
12,40	35	2,80 - 12,0	1/4"	25,89
16,50	40	3,20 - 16,0	1/4"	27,73
20,50	41	3,50 - 20,0	1/4"	33,27

AV1...CR					
	D1	L1	D min. -D max.	Hexagon	€
	mm	mm	mm	1/4"	
AV101CR	10,00	40	2,0 - 5,0	1/4"	22,66
AV102CR	14,00	42	5,0 - 10,0	1/4"	28,33
AV103CR	17,00	45	5,0 - 13,0	1/4"	50,73
AV104CR	25,00	55	7,0 - 20,0	1/4"	90,60

HERRAMIENTAS CON MANGO HEXAGONAL 1/4"
BROCA PARA PARED

Ref. BWH

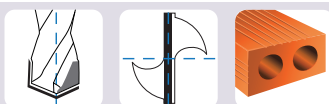

BROCA PARA MADERA

Ref. BMH

CV



BWH				
	Ø mm	L1 x L2 mm		€
BWH03	3	70 x 30	1/4"	3,23
BWH04	4	70 x 30	1/4"	3,50
BWH05	5	85 x 45	1/4"	3,79
BWH06	6	100 x 50	1/4"	4,21
BWH07	7	100 x 50	1/4"	4,95
BWH08	8	120 x 70	1/4"	5,72
BWH09	9	120 x 70	1/4"	6,85
BWH10	10	120 x 70	1/4"	7,67
BWH11	11	150 x 80	1/4"	9,54
BWH12	12	150 x 80	1/4"	10,78
BWH13	13	150 x 80	1/4"	13,27
BWH14	14	150 x 80	1/4"	15,46

BMH				
	Ø mm	L1 x L2 mm		€
BMH03	3	59 x 35	1/4"	2,07
BMH04	4	74 x 41	1/4"	2,17
BMH05	5	82 x 55	1/4"	2,15
BMH06	6	88 x 58	1/4"	2,90
BMH07	7	110 x 70	1/4"	3,29
BMH08	8	110 x 70	1/4"	3,42
BMH09	9	110 x 70	1/4"	3,56
BMH10	10	115 x 75	1/4"	3,94
BMH11	11	135 x 85	1/4"	4,60
BMH12	12	135 x 85	1/4"	5,40
BMH13	13	135 x 90	1/4"	8,45
BMH14	14	145 x 95	1/4"	10,51



REFERENCIA	BWH9318	BWH9327	BWH9319	BMH9335	BMH9333
Nº BROCAS	5	5	8	5	8
APLICACIÓN	PARED	PARED	PARED	MADERA	MADERA
CONTENIDO	Ø 3 - 4 - 5 - 6 - 8 mm	Ø 4 - 5 - 6 - 8 - 10 mm	Ø 3 - 4 - 5 - 6 - 7 - 8 - 9 - 10 mm	Ø 3 - 4 - 5 - 6 - 8 mm	Ø 3 - 4 - 5 - 6 - 7 - 8 - 9 - 10 mm
P.V.P. €	27,28	32,92	37,70	16,93	22,33



ESTUCHES DE HERRAMIENTAS CON MANGO HEXAGONAL 1/4"

Ref. EB



Ref. EMBP

CONTENIDO

	 HSS-G	 HSS-G			€
EM	M3 - M4 - M5 - M6 M8 - M10	-	-	-	72,19
EMBP	M3 - M4 - M5 - M6 M8 - M10	Ø 2,50 - 3,30 - 4,20 5 - 6,80 - 8,50	-	-	104,08
EBM	-	-	M3 - M4 - M5 - M6 M8 - M10	-	158,91
EA	-	-	-	Ø 6,30 - 8,30 - 10,40 12,40 - 16,50 - 20,50	145,70
EB	-	Ø 1 - 10 mm x 0,50	-	-	121,39