

BLUE-MASTER[®]
by *celesa*



1/4" SHANK
TOOLS

INTERCHANGEABLE SCREWDRIVER BITS
Plus

25mm
 OVERALL
 LENGTH
 (L₁)

PHILLIPS

€ per Bit		2 U		5 U		50 U		100 U	
	L1 mm		€		€		€		€
Ph 0	25	Ph0-2	1,55	Ph0-5	1,36	Ph0-50	1,21	Ph0-100	1,16
Ph 1	25	Ph1-2	1,30	Ph1-5	0,81	Ph1-50	0,73	Ph1-100	0,68
Ph 2	25	Ph2-2	1,30	Ph2-5	0,81	Ph2-50	0,73	Ph2-100	0,68
Ph 3	25	Ph3-2	1,30	Ph3-5	0,81	Ph3-50	0,73	Ph3-100	0,68

POZIDRIV

€ per Bit		2 U		5 U		50 U		100 U	
	L1 mm		€		€		€		€
Pz 0	25	Pz0-2	1,55	Pz0-5	1,36	Pz0-50	1,21	Pz0-100	1,16
Pz 1	25	Pz1-2	1,30	Pz1-5	0,81	Pz1-50	0,73	Pz1-100	0,68
Pz 2	25	Pz2-2	1,30	Pz2-5	0,81	Pz2-50	0,73	Pz2-100	0,68
Pz 3	25	Pz3-2	1,30	Pz3-5	0,81	Pz3-50	0,73	Pz3-100	0,68

SLOT

€ per Bit		2 U		5 U		50 U		100 U	
	L1 mm		€		€		€		€
0,5X3,0	25	P0,5X3,0-2	1,76	P0,5X3,0-5	1,52	P0,5X3,0-50	1,38	P0,5X3,0-100	1,31
0,6X3,5	25	P0,6X3,5-2	1,76	P0,6X3,5-5	1,52	P0,6X3,5-50	1,38	P0,6X3,5-100	1,31
0,5X4,0	25	P0,5X4,0-2	1,76	P0,5X4,0-5	1,52	P0,5X4,0-50	1,38	P0,5X4,0-100	1,31
0,6X4,5	25	P0,6X4,5-2	1,76	P0,6X4,5-5	1,52	P0,6X4,5-50	1,38	P0,6X4,5-100	1,31
0,8X4,0	25	P0,8X4,0-2	1,76	P0,8X4,0-5	1,52	P0,8X4,0-50	1,38	P0,8X4,0-100	1,31
0,8X5,0	25	P0,8X5,0-2	1,76	P0,8X5,0-5	1,52	P0,8X5,0-50	1,38	P0,8X5,0-100	1,31
0,8X5,5	25	P0,8X5,5-2	1,76	P0,8X5,5-5	1,52	P0,8X5,5-50	1,38	P0,8X5,5-100	1,31
1,0X5,5	25	P1X5,5-2	1,76	P1X5,5-5	1,52	P1X5,5-50	1,38	P1X5,5-100	1,31
1,0X6,0	25	P1X6,0-2	1,76	P1X6,0-5	1,52	P1X6,0-50	1,38	P1X6,0-100	1,31
1,2X6,5	25	P1,2X6,5-2	1,76	P1,2X6,5-5	1,52	P1,2X6,5-50	1,38	P1,2X6,5-100	1,31
1,2X8,0	25	P1,2X8,0-2	1,76	P1,2X8,0-5	1,52	P1,2X8,0-50	1,38	P1,2X8,0-100	1,31

INTERCHANGEABLE SCREWDRIVER BITS



25mm
OVERALL
LENGTH
(L₁)



	€ per Bit		2 U		5 U		50 U		100 U	
	L1 mm	€		€		€		€		€
T5	25		PT5-2	2,32	PT5-5	2,01	PT5-50	1,82	PT5-100	1,72
T6	25		PT6-2	2,32	PT6-5	2,01	PT6-50	1,82	PT6-100	1,72
T7	25		PT7-2	2,32	PT7-5	2,01	PT7-50	1,82	PT7-100	1,72
T8	25		PT8-2	2,32	PT8-5	2,01	PT8-50	1,82	PT8-100	1,72
T9	25		PT9-2	2,32	PT9-5	2,01	PT9-50	1,82	PT9-100	1,72
T10	25		PT10-2	1,91	PT10-5	1,49	PT10-50	1,33	PT10-100	1,26
T15	25		PT15-2	1,91	PT15-5	1,49	PT15-50	1,33	PT15-100	1,26
T20	25		PT20-2	1,91	PT20-5	1,49	PT20-50	1,33	PT20-100	1,26
T25	25		PT25-2	1,91	PT25-5	1,49	PT25-50	1,33	PT25-100	1,26
T27	25		PT27-2	1,91	PT27-5	1,49	PT27-50	1,33	PT27-100	1,26
T30	25		PT30-2	1,91	PT30-5	1,49	PT30-50	1,33	PT30-100	1,26
T40	25		PT40-2	1,91	PT40-5	1,49	PT40-50	1,33	PT40-100	1,26



	€ per Bit		2 U		5 U		50 U		100 U	
	L1 mm	€		€		€		€		€
TR10	25		PTR10-2	6,17	PTR10-5	5,36	PTR10-50	4,84	PTR10-100	4,55
TR15	25		PTR15-2	6,17	PTR15-5	5,36	PTR15-50	4,84	PTR15-100	4,55
TR20	25		PTR20-2	6,17	PTR20-5	5,36	PTR20-50	4,84	PTR20-100	4,55
TR25	25		PTR25-2	6,17	PTR25-5	5,36	PTR25-50	4,84	PTR25-100	4,55
TR30	25		PTR30-2	6,17	PTR30-5	5,36	PTR30-50	4,84	PTR30-100	4,55
TR40	25		PTR40-2	6,17	PTR40-5	5,36	PTR40-50	4,84	PTR40-100	4,55

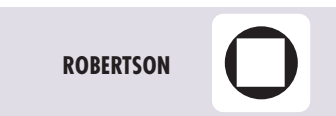

	€ per Bit		2 U		5 U		50 U		100 U	
	L1 mm	€		€		€		€		€
Nº1	25		PC1-2	2,48	PC1-5	2,17	PC1-50	1,95	PC1-100	1,84
Nº2	25		PC2-2	2,48	PC2-5	2,17	PC2-50	1,95	PC2-100	1,84
Nº3	25		PC3-2	2,48	PC3-5	2,17	PC3-50	1,95	PC3-100	1,84

INTERCHANGEABLE SCREWDRIVER BITS

25mm
OVERALL
LENGTH
(L)

**TORX
SECURITY**

€ per Bit		2 U		5 U		50 U		100 U	
	L1 mm		€		€		€		€
TS10	25	PTS10-2	3,31	PTS10-5	2,87	PTS10-50	2,59	PTS10-100	2,44
TS15	25	PTS15-2	3,31	PTS15-5	2,87	PTS15-50	2,59	PTS15-100	2,44
TS20	25	PTS20-2	3,31	PTS20-5	2,87	PTS20-50	2,59	PTS20-100	2,44
TS25	25	PTS25-2	3,31	PTS25-5	2,87	PTS25-50	2,59	PTS25-100	2,44
TS27	25	PTS27-2	3,31	PTS27-5	2,87	PTS27-50	2,59	PTS27-100	2,44
TS30	25	PTS30-2	3,31	PTS30-5	2,87	PTS30-50	2,59	PTS30-100	2,44
TS40	25	PTS40-2	3,31	PTS40-5	2,87	PTS40-50	2,59	PTS40-100	2,44

HEXAGONAL

€ per Bit		2 U		5 U		50 U		100 U	
	L1 mm		€		€		€		€
2 mm	25	PHX2-2	1,83	PHX2-5	1,66	PHX2-50	1,48	PHX2-100	1,42
2,5 mm	25	PHX2,5-2	1,83	PHX2,5-5	1,66	PHX2,5-50	1,48	PHX2,5-100	1,42
3 mm	25	PHX3-2	1,83	PHX3-5	1,66	PHX3-50	1,48	PHX3-100	1,42
4 mm	25	PHX4-2	1,83	PHX4-5	1,66	PHX4-50	1,48	PHX4-100	1,42
5 mm	25	PHX5-2	1,83	PHX5-5	1,66	PHX5-50	1,48	PHX5-100	1,42
6 mm	25	PHX6-2	1,83	PHX6-5	1,66	PHX6-50	1,48	PHX6-100	1,42
8 mm	25	PHX8-2	2,17	PHX8-5	1,97	PHX8-50	1,90	PHX8-100	1,79

**TRI
WING**

€ per Bit		2 U		5 U		50 U		100 U	
	L1 mm		€		€		€		€
N°4	25	PTRW4-2	10,92	PTRW4-5	9,50	PTRW4-50	8,55	PTRW4-100	8,08
N°5	25	PTRW5-2	10,92	PTRW5-5	9,50	PTRW5-50	8,55	PTRW5-100	8,08
N°6	25	PTRW6-2	10,92	PTRW6-5	9,50	PTRW6-50	8,55	PTRW6-100	8,08
N°8	25	PTRW8-2	10,92	PTRW8-5	9,50	PTRW8-50	8,55	PTRW8-100	8,08

XZN

€ per Bit		2 U		5 U		50 U		100 U	
	L1 mm		€		€		€		€
N°4	25	PXZN4-2	6,69	PXZN4-5	5,83	PXZN4-50	5,24	PXZN4-100	4,95
N°5	25	PXZN5-2	6,69	PXZN5-5	5,83	PXZN5-50	5,24	PXZN5-100	4,95
N°6	25	PXZN6-2	6,69	PXZN6-5	5,83	PXZN6-50	5,24	PXZN6-100	4,95
N°8	25	PXZN8-2	7,51	PXZN8-5	6,53	PXZN8-50	6,41	PXZN8-100	6,29
N°10	25	PXZN10-2	7,51	PXZN10-5	6,53	PXZN10-50	6,41	PXZN10-100	6,29

INTERCHANGEABLE SCREWDRIVER BITS



50mm
OVERALL
LENGTH
(L₁)

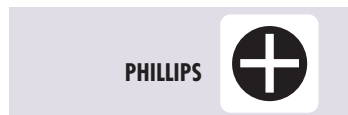

€ per Bit		2 U		5 U		50 U	
	L1 mm		€		€		€
Ph 1	50	Ph1X50-2	2,97	Ph1X50-5	2,59	Ph1X50-50	2,33
Ph 2	50	Ph2X50-2	2,97	Ph2X50-5	2,59	Ph2X50-50	2,33
Ph 3	50	Ph3X50-2	2,97	Ph3X50-5	2,59	Ph3X50-50	2,33
Ph 4	50	Ph4X50-2	-	Ph4X50-5	-	Ph4X50-50	-

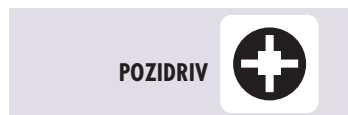

€ per Bit		2 U		5 U		50 U	
	L1 mm		€		€		€
Pz 1	50	Pz1X50-2	2,97	Pz1X50-5	2,59	Pz1X50-50	2,33
Pz 2	50	Pz2X50-2	2,97	Pz2X50-5	2,59	Pz2X50-50	2,33
Pz 3	50	Pz3X50-2	2,97	Pz3X50-5	2,59	Pz3X50-50	2,33
Pz 4	50	Pz4X50-2	-	Pz4X50-5	-	Pz4X50-50	-

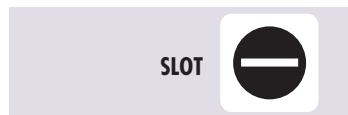

€ per Bit		2 U		5 U		50 U	
	L1 mm		€		€		€
0,5X4,0	50	P0,5X4,0X50-2	4,69	P0,5X4,0X50-5	4,06	P0,5X4,0X50-50	3,64
0,5X3,0	50	P0,5X3,0X50-2	4,69	P0,5X3,0X50-5	4,06	P0,5X3,0X50-50	3,64
0,6X3,5	50	P0,6X3,5X50-2	4,69	P0,6X3,5X50-5	4,06	P0,6X3,5X50-50	3,64
0,6X4,5	50	P0,6X4,5X50-2	4,69	P0,6X4,5X50-5	4,06	P0,6X4,5X50-50	3,64
0,8X4,0	50	P0,8X4,0X50-2	4,69	P0,8X4,0X50-5	4,06	P0,8X4,0X50-50	3,64
0,8X5,0	50	P0,8X5,0X50-2	4,69*	P0,8X5,0X50-5	4,06*	P0,8X5,0X50-50	3,64*
0,8X5,5	50	P0,8X5,5X50-2	4,69	P0,8X5,5X50-5	4,06	P0,8X5,5X50-50	3,64
1,0X5,5	50	P1X5,5X50-2	4,69	P1X5,5X50-5	4,06	P1X5,5X50-50	3,64
1,0X6,0	50	P1X6,0X50-2	4,69	P1X6,0X50-5	4,06	P1X6,0X50-50	3,64
1,2X6,5	50	P1,2X6,5X50-2	4,69	P1,2X6,5X50-5	4,06	P1,2X6,5X50-50	3,64
1,2X8,0	50	P1,2X8,0X50-2	4,69	P1,2X8,0X50-5	4,06	P1,2X8,0X50-50	3,64

*Until end of stock

INTERCHANGEABLE SCREWDRIVER BITS
Plus

50mm
 OVERALL
 LENGTH
 (L)

TORX

€ per Bit		2 U		5 U		50 U	
	L1 mm		€		€		€
T 5	50	PT5X50-2	6,00	PT5X50-5	4,57	PT5X50-50	4,23
T 6	50	PT6X50-2	6,00	PT6X50-5	4,57	PT6X50-50	4,23
T 7	50	PT7X50-2	6,00	PT7X50-5	4,57	PT7X50-50	4,23
T 8	50	PT8X50-2	6,00	PT8X50-5	4,57	PT8X50-50	4,23
T 9	50	PT9X50-2	6,00	PT9X50-5	4,57	PT9X50-50	4,23
T 10	50	PT10X50-2	5,52	PT10X50-5	4,30	PT10X50-50	3,87
T 15	50	PT15X50-2	5,52	PT15X50-5	4,30	PT15X50-50	3,87
T 20	50	PT20X50-2	5,52	PT20X50-5	4,30	PT20X50-50	3,87
T 25	50	PT25X50-2	5,52	PT25X50-5	4,30	PT25X50-50	3,87
T 27	50	PT27X50-2	5,52	PT27X50-5	4,30	PT27X50-50	3,87
T 30	50	PT30X50-2	5,52	PT30X50-5	4,30	PT30X50-50	3,87
T 40	50	PT40X50-2	5,52	PT40X50-5	4,30	PT40X50-50	3,87

ROBERTSON

€ per Bit		2 U		5 U		50 U	
	L1 mm		€		€		€
N°1	50	PC1X50-2	7,20	PC1X50-5	6,26	PC1X50-50	5,64
N°2	50	PC2X50-2	7,20	PC2X50-5	6,26	PC2X50-50	5,64
N°3	50	PC3X50-2	7,20	PC3X50-5	6,26	PC3X50-50	5,64

HEXAGONAL

€ per Bit		2 U		5 U		50 U	
	L1 mm		€		€		€
2 mm	50	PHX2X50-2	5,83	PHX2X50-5	5,07	PHX2X50-50	4,56
2,5 mm	50	PHX2,5X50-2	5,83	PHX2,5X50-5	5,07	PHX2,5X50-50	4,56
3 mm	50	PHX3X50-2	5,83	PHX3X50-5	5,07	PHX3X50-50	4,56
4 mm	50	PHX4X50-2	5,83	PHX4X50-5	5,07	PHX4X50-50	4,56
5 mm	50	PHX5X50-2	5,83	PHX5X50-5	5,07	PHX5X50-50	4,56
6 mm	50	PHX6X50-2	5,83	PHX6X50-5	5,07	PHX6X50-50	4,56
8 mm	50	PHX8X50-2	7,47	PHX8X50-5	6,84	PHX8X50-50	5,85

INTERCHANGEABLE SCREWDRIVER BITS



70mm
OVERALL
LENGTH
(L₁)



PHILLIPS



€ per Bit		2 U		5 U	
	L1 mm		€		€
Ph 1	70	Ph1X70-2	6,97	Ph1X70-5	6,07
Ph 2	70	Ph2X70-2	6,97	Ph2X70-5	6,07
Ph 3	70	Ph3X70-2	6,97	Ph3X70-5	6,07
Ph 4	70	Ph4X70-2	-	Ph4X70-5	-

POZIDRIV



€ per Bit		2 U		5 U	
	L1 mm		€		€
Pz 1	70	Pz1X70-2	7,04	Pz1X70-5	6,12
Pz 2	70	Pz2X70-2	7,04	Pz2X70-5	6,12
Pz 3	70	Pz3X70-2	7,04	Pz3X70-5	6,12
Pz 4	70	Pz4X70-2	-	Pz4X70-5	-



90mm
OVERALL
LENGTH
(L₁)



PHILLIPS



€ per Bit		2 U		5 U	
	L1 mm		€		€
Ph 1	90	Ph1X90-2	8,59	Ph1X90-5	7,48
Ph 2	90	Ph2X90-2	8,59	Ph2X90-5	7,48
Ph 3	90	Ph3X90-2	8,59	Ph3X90-5	7,48
Ph 4	90	Ph4X90-2	-	Ph4X90-5	-

POZIDRIV



€ per Bit		2 U		5 U	
	L1 mm		€		€
Pz 1	90	Pz1X90-2	8,67	Pz1X90-5	7,55
Pz 2	90	Pz2X90-2	8,67	Pz2X90-5	7,55
Pz 3	90	Pz3X90-2	8,67	Pz3X90-5	7,55
Pz 4	90	Pz4X90-2	-	Pz4X90-5	-

INTERCHANGEABLE SCREWDRIVER BITS
TiN

25mm
 OVERALL
 LENGTH
 (L)

PHILLIPS

€ per Bit
2 U
5 U
50 U

	L1 mm		€		€		€
Ph 1	25	Ph1T-2	3,51	Ph1T-5	2,65	Ph1T-50	2,38
Ph 2	25	Ph2T-2	3,51	Ph2T-5	2,65	Ph2T-50	2,38
Ph 3	25	Ph3T-2	3,51	Ph3T-5	2,65	Ph3T-50	2,38

POZIDRIV

€ per Bit
2 U
5 U
50 U

	L1 mm		€		€		€
Pz 1	25	Pz1T-2	3,54	Pz1T-5	2,67	Pz1T-50	2,41
Pz 2	25	Pz2T-2	3,54	Pz2T-5	2,67	Pz2T-50	2,41
Pz 3	25	Pz3T-2	3,54	Pz3T-5	2,67	Pz3T-50	2,41

SLOT

€ per Bit
2 U
5 U
50 U

	L1 mm		€		€		€
0,6X4,5	25	PO,6X4,5T-2	3,80	PO,6X4,5T-5	3,29	PO,6X4,5T-50	2,96
0,8X5,5	25	PO,8X5,5T-2	3,80	PO,8X5,5T-5	3,29	PO,8X5,5T-50	2,96
1,0X5,5	25	P1X5,5T-2	3,80	P1X5,5T-5	3,29	P1X5,5T-50	2,96
1,2X6,5	25	P1,2X6,5T-2	3,80	P1,2X6,5T-5	3,29	P1,2X6,5T-50	2,96

TORX

€ per Bit
2 U
5 U
50 U

	L1 mm		€		€		€
T 10	25	PT10T-2	3,65	PT10T-5	3,28	PT10T-50	2,87
T 15	25	PT15T-2	3,65	PT15T-5	3,28	PT15T-50	2,87
T 20	25	PT20T-2	3,65	PT20T-5	3,28	PT20T-50	2,87
T 25	25	PT25T-2	3,65	PT25T-5	3,28	PT25T-50	2,87
T 27	25	PT27T-2	3,65	PT27T-5	3,28	PT27T-50	2,87
T 30	25	PT30T-2	3,65	PT30T-5	3,28	PT30T-50	2,87
T 40	25	PT40T-2	3,65	PT40T-5	3,28	PT40T-50	2,87

INTERCHANGEABLE SCREWDRIVER BITS

TiN  **50mm OVERALL LENGTH (L)**



PHILLIPS 



€ per Bit		2 U		5 U		50 U	
	L1 mm		€		€		€
Ph 1	50	Ph1Tx50-2	8,09	Ph1Tx50-5	7,03	Ph1Tx50-50	6,31
Ph 2	50	Ph2Tx50-2	8,09	Ph2Tx50-5	7,03	Ph2Tx50-50	6,31
Ph 3	50	Ph3Tx50-2	8,09	Ph3Tx50-5	7,03	Ph3Tx50-50	6,31

POZIDRIV 



€ per Bit		2 U		5 U		50 U	
	L1 mm		€		€		€
Pz 1	50	Pz1Tx50-2	8,17	Pz1Tx50-5	7,10	Pz1Tx50-50	6,37
Pz 2	50	Pz2Tx50-2	8,17	Pz2Tx50-5	7,10	Pz2Tx50-50	6,37
Pz 3	50	Pz3Tx50-2	8,17	Pz3Tx50-5	7,10	Pz3Tx50-50	6,37

TORX 



€ per Bit		2 U		5 U		50 U	
	L1 mm		€		€		€
T 10	50	PT10Tx50-2	11,57	PT10Tx50-5	10,06	PT10Tx50-50	9,05
T 15	50	PT15Tx50-2	11,57	PT15Tx50-5	10,06	PT15Tx50-50	9,05
T 20	50	PT20Tx50-2	11,57	PT20Tx50-5	10,06	PT20Tx50-50	9,05
T 25	50	PT25Tx50-2	11,57	PT25Tx50-5	10,06	PT25Tx50-50	9,05
T 27	50	PT27Tx50-2	11,57	PT27Tx50-5	10,06	PT27Tx50-50	9,05
T 30	50	PT30Tx50-2	11,57	PT30Tx50-5	10,06	PT30Tx50-50	9,05
T 40	50	PT40Tx50-2	11,57	PT40Tx50-5	10,06	PT40Tx50-50	9,05

SCREWDRIVER BIT HOLDERS
MAGNETIC SCREWDRIVER BIT HOLDERS

	L1 mm	SHANK TYPE	€
PMGx51	51	MAGNETIC WITHOUT RING	6,99
PMGx58	58	MAGNETIC WITHOUT RING	7,26
PMGx74	74	MAGNETIC WITH RING	11,97
PMGx100	100	MAGNETIC WITH RING	14,48
PMGx150	150	MAGNETIC WITH RING	16,13
PMGx200	200	MAGNETIC WITH RING	19,09
PMGx250	250	MAGNETIC WITH RING	29,36
PMGSDSx78	78	SDS PLUS	20,03
PBERx74	74	BERYLLIUM	51,40*
PDESSx70	70	5/16" DESSOUTTER	31,67*
P7x74	74	7mm Fein	34,40*

*Until end of stock

MAGNETIC HOLDER WITH QUICK CHANGE (VALID FOR 1/4" SCREWDRIVER BITS WITH CIRCLIP)

	L1 mm	SHANK TYPE	€
PCRx60	60	Quick change 1/4" Valid for 1/4" screwdriver bits with circlip	17,81
PCRx74	74	Quick change 1/4" Valid for 1/4" screwdriver bits with circlip	18,34
PCRSDSx80	80	SDS PLUS	29,21

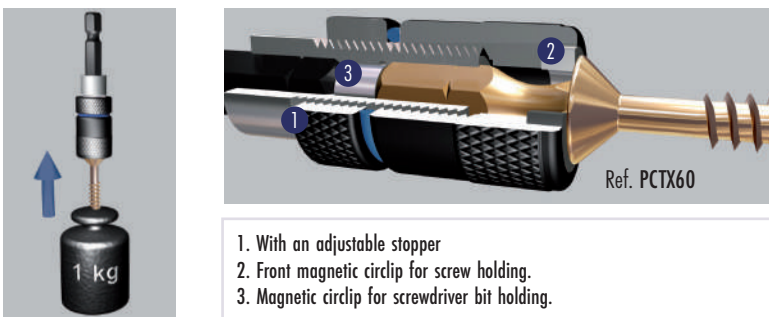
SCREWDRIVER BITS HOLDERS WITH ADJUSTABLE STOPPER

	L1 mm	SHANK TYPE	€
PCTX60	60	Adjustable stopper	16,77



STANDARD HEXAGONAL NUT DRIVERS



MAGNETIC HEXAGONAL NUT DRIVERS



	mm	"		€/ 10.
PLIHX5-2	5,0		2	6,35
PLIHX5,5-2	5,5		2	6,35
PLIHX6-2	6,0		2	6,35
PLIHX1/4-2		1/4"=6,35	2	6,35
PLIHX7-2	7,0		2	6,49
PLIHX5/16-2		5/16"=7,93	2	6,49
PLIHX8-2	8,0		2	6,49
PLIHX3/8-2		3/8"=9,52	2	6,49
PLIHX10-2	10,0		2	6,65
PLIHX11-2	11,0		2	6,84
PLIHX12-2	12,0		2	6,90
PLIHX13-2	13,0		2	7,23

7 MAGNETIC HEXAGONAL NUT DRIVERS BOX

REFERENCE QUANTITY	EPLL
	7
CONTENT	HX1/4 - HX7 - HX8 - HX3/8 HX10 - HX12 - HX13
PRICE €	47,09



RATCHET SCREWDRIVER WITH BITS STORAGE



1. High quality and performance
2. Left and right hand turn
3. Telescopic and adjustable
4. Manufactured in high quality plastic and steel

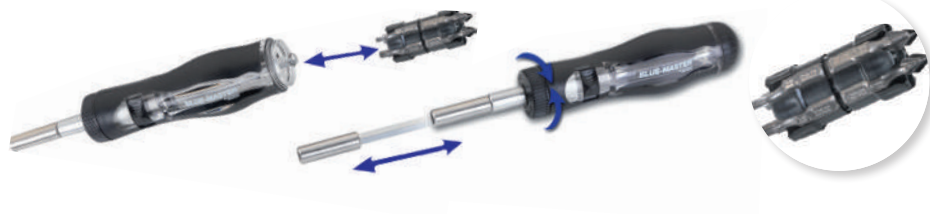
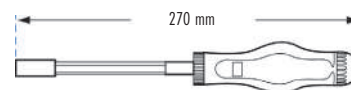
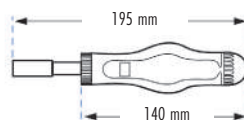

DTRC

- Screwdriver bits included:
- PH1 - PH2
 - PZ1 - PZ2
 - T15 - T20 - T25 - T30

35,77 €

SCREWDRIVER BITS SETS

DiN 7 SCREWDRIVER BIT SETS



Ref. EPT1

REFERENCE QUANTITY	EPT1	EPT2	EPT3
	7	7	7
CONTENT	PH1 - PH2 PZ1 - PZ2 0,8x5,5 - 1,2x6,5 1 PMG Bit holder	T10 - T15 T20 - T25 T30 - T40 1 PMG Bit holder	PH1 - PH2 - PH3 PZ1 - PZ2 - PZ3 1 PMG Bit holder
PRICE €	12,45	16,78	14,92





Ref. EPTT1

REFERENCE QUANTITY	EPTT1	EPTT2	EPTT3
	7	7	7
CONTENT	PH1 - PH2 PZ1 - PZ2 0,8x5,5 - 1,2x6,5 1 PMG Bit holder	T10 - T15 T20 - T25 T30 - T40 1 PMG Bit holder	PH1 - PH2 - PH3 PZ1 - PZ2 - PZ3 1 PMG Bit holder
PRICE €	35,31	40,95	34,04

SCREWDRIVER BITS SETS

PLUS & TiN 12 SCREWDRIVER BIT SETS

 Ref. EPT4	REFERENCE	EPT4	EPT5
	QUANTITY	12	12
	CONTENT	<ul style="list-style-type: none"> ⊕ PH1 - PH2(2) - PH3 ⊕ PZ1 - PZ2(2) - PZ3 ⊖ 0,6x4,5 - 0,8x5,5 - 1,2x6,5 1 PMG Bit holder	<ul style="list-style-type: none"> ★ T10 - T15(2) ★ T20(2) - T25(2) T27 - T30(2) - T40 1 PMG Bit holder
PRICE €	16,70	22,93	

 Ref. EPTT4	REFERENCE	EPTT4	EPTT5
	QUANTITY	12	12
	CONTENT	<ul style="list-style-type: none"> ⊕ PH1 - PH2(2) - PH3 ⊕ PZ1 - PZ2(2) - PZ3 ⊖ 0,6x4,5 - 0,8x5,5 - 1,2x6,5 1 PCT Bit holder	<ul style="list-style-type: none"> T10 - T15(2) ★ T20(2) - T25(2) T27 - T30(2) - T40 1 PCT Bit holder
PRICE €	44,47	52,31	

PLUS & TiN 31 SCREWDRIVER BIT SETS

 Ref. EPT6	REFERENCE	EPT6
	QUANTITY	31
	CONTENT	<ul style="list-style-type: none"> ⊕ PH1(3) - PH2(3) - PH3(3) ⊕ PZ1(3) - PZ2(3) - PZ3(3) ⊖ 0,6x4,5 - 0,8x5,5 - 1,2x6,5 1 PMG Bit holder
PRICE €	47,72	

REFERENCE	EPTT6
QUANTITY	31
CONTENT	<ul style="list-style-type: none"> ⊕ PH1(3) - PH2(3) - PH3(3) ⊕ PZ1(3) - PZ2(3) - PZ3(3) ⊖ 0,6x4,5 - 0,8x5,5 - 1,2x6,5 1 PCT Bit holder
PRICE €	101,25

PLUS & TiN 36 SCREWDRIVER BIT SETS

 Ref. EPT7	REFERENCE	EPT7
	QUANTITY	36
	CONTENT	<ul style="list-style-type: none"> ⊕ PH1(3) - PH2(3) - PH3(3) ⊕ PZ1(3) - PZ2(3) - PZ3(3) ⊖ 0,5 x 4 - 0,6 x 4,5 - 0,8 x 5 - 0,8 x 5,5 - 1 x 6 - 1,2 x 6,5 - 1,2 x 8 1 PMG Bit holder
PRICE €	60,43	

 Ref. EPTT7	REFERENCE	EPTT7*
	QUANTITY	36
	CONTENT	<ul style="list-style-type: none"> ⊕ PH1(3) - PH2(3) - PH3(3) ⊕ PZ1(3) - PZ2(3) - PZ3(3) ⊖ 0,5 x 4 - 0,6 x 4,5 - 0,8 x 5 - 0,8 x 5,5 - 1 x 6 - 1,2 x 6,5 - 1,2 x 8 1 PCT Bit holder
PRICE €	123,99*	

*Until end of stock

SCREWDRIVER BITS SETS

45 & 80 SCREWDRIVER BITS SETS



Ref. EPT45



Ref. EPT80



REFERENCE	EPT45	
QUANTITY	45	
CONTENT	<ul style="list-style-type: none"> PH1(2) - PH2(2) - PH3(2) PZ1(2) - PZ2(2) - PZ3(2) 0,5x3-0,6x4,5-0,8x5,5(2)-1,2x6,5-1,6x8 H2,5 - H3 - H4 - H5 - H6 - H7 T10 - T15 - T20 - T25 - T30 - T40 	<ul style="list-style-type: none"> Hexagonal sockets (mm): 5 - 6 - 7 - 8 - 9 - 10 - 11 - 12 - 13 - 14 1 Sockets adapter 1 Screwdriver bits adapter 1 PCR Magnetic bit holder 1 Ratched handle 72 teeth 1 Screwdriver
PRICE €	151,21	



REFERENCE	EPT80*	
QUANTITY	80	
CONTENT	<ul style="list-style-type: none"> PH0 - PH1 - PH2(4) - PH3(2) PZ1 - PZ2(4) - PZ3(2) 0,5x3-0,6x4,5-0,8x5,5(2)-1,2x6,5-1,6x8 H2 - H2,5 - H3 - H4 - H5 - H6 - H7 - H8 TW1 - TW2 - TW3 - TW4 - TW5 TQ5 - TQ6 - TQ8 - TQ10 T5 - T6 - T7 - T8 - T9 - T10 - T15 T20(2) - T25(2) - T27 - T30 - T40 TS10 - TS15 - TS20 - TS25 - TS30 - TS40 	<ul style="list-style-type: none"> C0 - C1 - C2 - C3 SP4 - SP6 - SP8 - SP10 HS3 - HS4 - HS5 - HS6 1 PCR Magnetic bit holder 1 Screwdriver
PRICE €	155,24*	

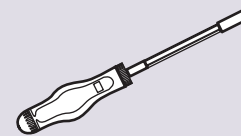

*Until end of stock

MACHINE SCREW EXTRACTORS

MICRO GRABIT

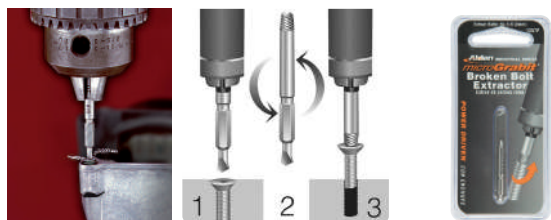

		EP
		€
EP451C	M3	55,10
EP452C	M4	55,10
EP453C	M5	55,10
EP454C	M6	55,10

1. Drill the screw
2. Flip the extractor
3. Remove

PRO GRABIT WITH 1/4" HEXAGONAL BODY

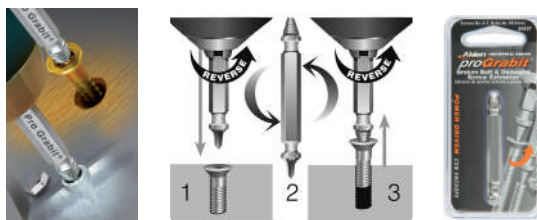

		EP
		€
EP8401C	M5	43,70
EP8402C	M6	51,63
EP8403C	M8	51,63
EP8404C	M10	54,18

1. Drill the screw
2. Flip the extractor
3. Remove

DRILL-OUT WITH PILOT DRILL (M6-M12)

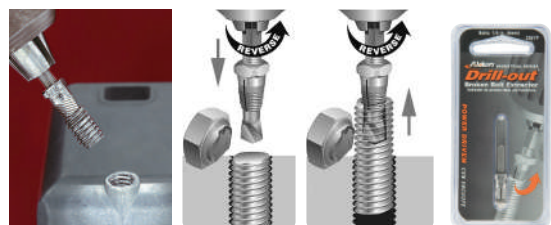

		EP
		€
EP205C	M6	53,42
EP312C	M8	64,73
EP375C	M10	64,73
EP500C	M12	72,86

X-OUT WITH HEXAGONAL SHANK



		EP
		€
EP3701C	M3	43,70
EP3702C	M4	43,70
EP3703C	M5	48,57

MACHINE SCREW EXTRACTORS SETS

MICRO GRABIT



REFERENCE	EP450C
QUANTITY	4
CONTENT	M3-M4-M5-M6
PRICE €	226,00

MICRO GRABIT



REFERENCE	EP401C
QUANTITY	4
CONTENT	M6-M8-M10-M12
PRICE €	265,87

HAND SCREW EXTRACTORS SETS

HAND SCREW EXTRACTOR CLASSIC SETS

Use a BLUE-MASTER drill to make a hole where to introduce the screw extractor.
Turn the extractor anti-clockwise until the broken screw comes out.

REFERENCE	EX/1-5	EX/1-6	EX/1-8
QUANTITY	5	6	8
CONTENT	M3 - M18	M3 - M24	M3 - M45
PRICE €	23,38	31,64	73,03

Ref. EX/1-6



	for SCREWS	mm	mm	L1 mm	Ø min mm	Ø max. mm	EX €
EX/1	M3 - M6	3,2	2,5	51	1,75	3,95	2,90
EX/2	M6 - M8	4,0	3,0	60	2,20	4,80	2,90
EX/3	M8 - M11	5,1	4,5	68	3,30	6,40	3,44
EX/4	M11 - M14	6,2	6,0	76	4,75	8,40	4,26
EX/5	M14 - M18	8,6	8,0	86	6,35	11,00	5,54
EX/6	M18 - M24	12,0	11,0	95	9,50	15,00	9,38
EX/7	M24 - M33	15,9	14,0	105	12,70	19,00	25,40
EX/8	M33 - M45	20,0	21,0	111	19,00	25,00	41,61

REFERENCE	EXTT
QUANTITY	10
CONTENT	EX/1-EX/2-EX/3-EX/4-EX/5 Ref. BC3 Ø2,5-3-4-5-6-8
PRICE €	39,01



HAND SCREW EXTRACTORS SETS



	for SCREWS	mm	mm	L1 mm	Ø min mm	Ø max. mm	EFX €
EFX/1	M3-M6	2,9	2,0	50	1,9	3,2	3,69
EFX/2	M6-M8	3,9	3,2	60	2,8	5,0	3,69
EFX/3	M8-M11	4,8	4,0	68	3,2	6,5	4,35
EFX/4	M11-M14	6,7	6,4	75	5,2	9,0	5,40
EFX/5	M14-M18	8,5	7,1	85	6,4	11,0	7,00
EFX/6	M18-M25	11,8	9,5	95	9,4	15,0	11,88
EFX/7	M25-M35	14,3	12,7	106	12,8	19,0	32,16
EFX/8	M35-M45	19,5	19,5	110	19,3	25,0	52,67

Ref. EFX/1-5



REFERENCE	EFX/1-5
QUANTITY	5
CONTENT	M3 - M18
PRICE €	28,16

DIN 338 TWIST DRILL

Ref. BH2

HSS



OX



	Ø mm	L1 x L2 mm	mm	BH2 €
BH20200	2,00	61 x 33	1/4"	7,52
BH20300	3,00	61 x 33	1/4"	7,69
BH20400	4,00	75 x 43	1/4"	8,14
BH20500	5,00	86 x 52	1/4"	10,12
BH20600	6,00	93 x 57	1/4"	10,93
BH20700	7,00	109 x 69	1/4"	13,78
BH20800	8,00	117 x 75	1/4"	15,47
BH20900	9,00	125 x 81	1/4"	17,40
BH21000	10,00	133 x 87	1/4"	19,38



REFERENCE	BH29335	BH29333
QUANTITY	5	8
QUALITY	HSS	HSS
CONTENT	Ø 3-4-5-6-8 mm	Ø 3-4-5-6-7-8-9-10 mm
PRICE €	53,15	71,10

1/4" HEXAGONAL SHANK TOOLS

EXTRA SHORT METAL DRILL

HSS-G

Ref. BC59

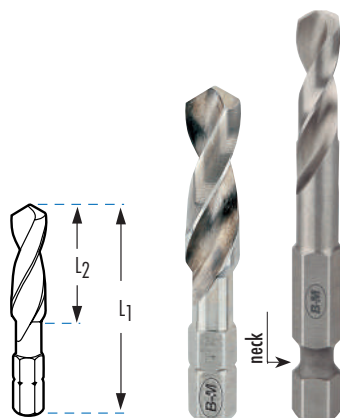



DRILL TAP COUNTERSINK

HSS-G

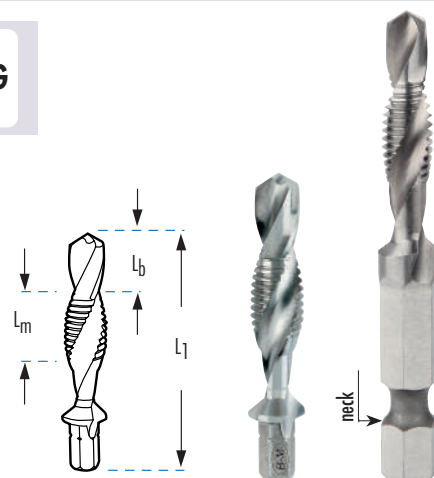
Ref. MAHM



				BC59	BC59CR
	Ø mm	L1 x L2 mm		€	€
BC590100	1,00	34 x 12	1/4"	7,52	-
BC590150	1,50	34 x 12	1/4"	7,52	-
BC590200	2,00	34 x 12	1/4"	7,52	7,52
BC590250	2,50	36 x 14	1/4"	7,52	7,52
BC590300	3,00	38 x 16	1/4"	7,52	7,52
BC590330	3,30	40 x 18	1/4"	7,52	7,52
BC590350	3,50	40 x 18	1/4"	7,52	7,52
BC590400	4,00	44 x 20	1/4"	7,52	7,52
BC590420	4,20	45 x 20	1/4"	7,52	7,52
BC590450	4,50	46 x 24	1/4"	7,52	7,52
BC590500	5,00	50 x 26	1/4"	7,52	7,52
BC590550	5,50	50 x 26	1/4"	8,21	8,21
BC590600	6,00	50 x 26	1/4"	8,21	8,21
BC590650	6,50	50 x 30	1/4"	8,21	8,21
BC590680	6,80	50 x 30	1/4"	8,21	8,21
BC590700	7,00	50 x 30	1/4"	8,21	8,21
BC590750	7,50	51 x 32	1/4"	9,29	9,29
BC590800	8,00	51 x 32	1/4"	9,29	9,29
BC590850	8,50	53 x 33	1/4"	9,29	9,29
BC590900	9,00	53 x 33	1/4"	11,21	11,21
BC590950	9,50	54 x 38	1/4"	11,21	11,21
BC591000	10,00	54 x 38	1/4"	11,21	11,21
BC591020	10,20	54 x 38	1/4"	11,21	11,21

			MAHM	MAHMCr
	L1 x Lb x Lm mm		€	€
M 3 x 0,50	36 x 5 x 6	1/4"	24,53	24,53
M 4 x 0,70	39 x 6 x 7	1/4"	24,53	24,53
M 5 x 0,80	41 x 8 x 8	1/4"	25,60	25,60
M 6 x 1,00	44 x 8 x 10	1/4"	26,66	26,66
M 8 x 1,25	50 x 10 x 11	1/4"	36,86	36,86
M 10 x 1,50	59 x 11 x 11	1/4"	44,47	44,47





REFERENCE	MAH9327CR
QUANTITY	5
DRILL REFERENCE	MAHMCr
CONTENT	M4-M5-M6-M8-M10
PRICE €	182,64

HSS-G TAP

HSS-G

Ref. M

			M	MCR
	L1 x L2 mm		€	€
M 3 x 0,50	33 x 11	1/4"	8,90	8,90
M 4 x 0,70	35 x 12	1/4"	8,90	8,90
M 5 x 0,80	36 x 15	1/4"	11,34	11,34
M 6 x 1,00	39 x 18	1/4"	11,34	11,34
M 8 x 1,25	40 x 19	1/4"	15,70	15,70
M 10 x 1,50	41 x 21	1/4"	19,39	19,39

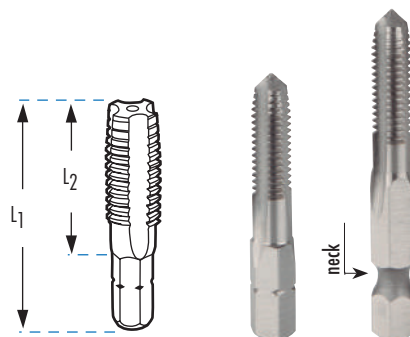

1/4" HEXAGONAL SHANK TOOLS

HSSCo STEP CUT DRILL-TAP WITH COUNTERSINK

NEW

DIN 13

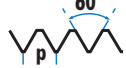

60°

HSSCo
5%

BRIGHT

TOL
6H

D
REDUCED
SHANK



Ref. MTKM

STEP CUT

										MTKM	
			Lb	Lm	L3	L	Db	D2	D3	€	
			mm	mm	mm	mm	mm	mm	mm		
M	3x0,50	D	7,0	6,0	6,0	57,0	2,5	2,2	7,3	1/4"	28,21
M	4x0,70	D	7,0	8,5	6,0	62,0	3,3	3,0	7,3	1/4"	28,21
M	5x0,80	D	9,0	10,0	6,0	69,0	4,2	3,7	7,3	1/4"	29,44
M	6x1,00	D	10,0	12,0	6,0	73,0	5,0	4,5	7,3	1/4"	30,66
M	8x1,25	D	12,0	16,0	6,0	87,0	6,8	6,3	9,4	1/4"	42,38
M	10x1,50	D	14,0	20,0	6,0	96,0	8,5	8,0	11,4	1/4"	51,14
M	12x1,75	D	16,0	24,0	8,0	112,0	10,3	9,8	13,4	1/4"	56,36

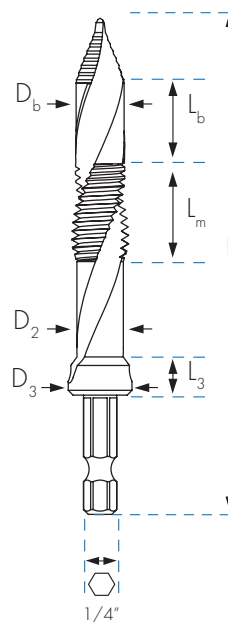

3 CUTS COUNTERSINKS

HSS-G

Ref. AV22

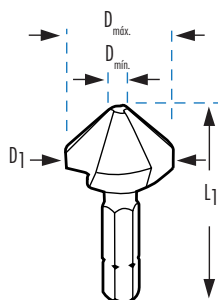

DEBURRING COUNTERSINK

HSS

Ref. AV1...CR



Ref. AV101CR
Ref. AV102CR



Ref. AV103CR
Ref. AV104CR

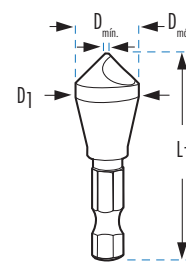

AV22				
D1	L1	D min. -D max.		€
mm	mm	mm	1/4"	
6,30	31	1,50 - 5,8	1/4"	22,65
8,30	31	2,00 - 7,8	1/4"	22,65
10,40	34	2,50 - 10,0	1/4"	24,27
12,40	35	2,80 - 12,0	1/4"	25,89
16,50	40	3,20 - 16,0	1/4"	27,73
20,50	41	3,50 - 20,0	1/4"	33,27

AV1...CR					
	D1	L1	D min. -D max.		€
	mm	mm	mm	1/4"	
AV101CR	10,00	40	2,0 - 5,0	1/4"	22,66
AV102CR	14,00	42	5,0 - 10,0	1/4"	28,33
AV103CR	17,00	45	5,0 - 13,0	1/4"	50,73
AV104CR	25,00	55	7,0 - 20,0	1/4"	90,60

1/4" HEXAGONAL SHANK TOOLS

PROFESSIONAL MASONRY DRILL

Ref. BWH

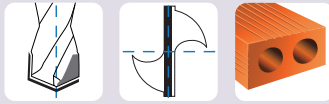



WOOD WORKING DRILL

Ref. BMH

CV



BWH				
	Ø mm	L1 x L2 mm		€
BWH03	3	70 x 30	1/4"	3,23
BWH04	4	70 x 30	1/4"	3,50
BWH05	5	85 x 45	1/4"	3,79
BWH06	6	100 x 50	1/4"	4,21
BWH07	7	100 x 50	1/4"	4,95
BWH08	8	120 x 70	1/4"	5,72
BWH09	9	120 x 70	1/4"	6,85
BWH10	10	120 x 70	1/4"	7,67
BWH11	11	150 x 80	1/4"	9,54
BWH12	12	150 x 80	1/4"	10,78
BWH13	13	150 x 80	1/4"	13,27
BWH14	14	150 x 80	1/4"	15,46

BMH				
	Ø mm	L1 x L2 mm		€
BMH03	3	59 x 35	1/4"	2,07
BMH04	4	74 x 41	1/4"	2,17
BMH05	5	82 x 55	1/4"	2,15
BMH06	6	88 x 58	1/4"	2,90
BMH07	7	110 x 70	1/4"	3,29
BMH08	8	110 x 70	1/4"	3,42
BMH09	9	110 x 70	1/4"	3,56
BMH10	10	115 x 75	1/4"	3,94
BMH11	11	135 x 85	1/4"	4,60
BMH12	12	135 x 85	1/4"	5,40
BMH13	13	135 x 90	1/4"	8,45
BMH14	14	145 x 95	1/4"	10,51



REFERENCE	BWH9318	BWH9327	BWH9319	BMH9335	BMH9333
QUANTITY	5	5	8	5	8
APPLICATION	CONCRETE	CONCRETE	CONCRETE	WOOD	WOOD
CONTENT	Ø 3 - 4 - 5 - 6 - 8 mm	Ø 4 - 5 - 6 - 8 - 10 mm	Ø 3 - 4 - 5 - 6 - 7 - 8 - 9 - 10 mm	Ø 3 - 4 - 5 - 6 - 8 mm	Ø 3 - 4 - 5 - 6 - 7 - 8 - 9 - 10 mm
PRICE €	27,28	32,92	37,70	16,93	22,33

1/4" HEXAGONAL SHANK DRILL BOXES



Ref. EB



Ref. EMBP

CONTENT

	 HSS-G	 HSS-G			€
EM	M3 - M4 - M5 - M6 M8 - M10	-	-	-	72,19
EMBP	M3 - M4 - M5 - M6 M8 - M10	Ø 2,50 - 3,30 - 4,20 5 - 6,80 - 8,50	-	-	104,08
EBM	-	-	M3 - M4 - M5 - M6 M8 - M10	-	158,91
EA	-	-	-	Ø 6,30 - 8,30 - 10,40 12,40 - 16,50 - 20,50	145,70
EB	-	Ø 1 - 10 mm x 0,50	-	-	121,39