

**BLUE-MASTER<sup>®</sup>**  
by *celesa*



OUTILS 1/4"

**EMBOUTS DE VISSAGE**
**Plus**

**25mm**  
 LONGUEUR  
 TOTALE  
 (L<sub>1</sub>)

**PHILLIPS**

€ x Embout	L1 mm	2 Unités		5 Unités		50 Unités		100 Unités	
			€		€		€		€
Ph 0	25	Ph0-2	<b>1,54</b>	Ph0-5	<b>1,34</b>	Ph0-50	<b>1,20</b>	Ph0-100	<b>1,14</b>
Ph 1	25	Ph1-2	<b>1,29</b>	Ph1-5	<b>0,80</b>	Ph1-50	<b>0,73</b>	Ph1-100	<b>0,67</b>
Ph 2	25	Ph2-2	<b>1,29</b>	Ph2-5	<b>0,80</b>	Ph2-50	<b>0,73</b>	Ph2-100	<b>0,67</b>
Ph 3	25	Ph3-2	<b>1,29</b>	Ph3-5	<b>0,80</b>	Ph3-50	<b>0,73</b>	Ph3-100	<b>0,67</b>

**POZIDRIV**

€ x Embout	L1 mm	2 Unités		5 Unités		50 Unités		100 Unités	
			€		€		€		€
Pz 0	25	Pz0-2	<b>1,54</b>	Pz0-5	<b>1,34</b>	Pz0-50	<b>1,20</b>	Pz0-100	<b>1,14</b>
Pz 1	25	Pz1-2	<b>1,29</b>	Pz1-5	<b>0,80</b>	Pz1-50	<b>0,73</b>	Pz1-100	<b>0,67</b>
Pz 2	25	Pz2-2	<b>1,29</b>	Pz2-5	<b>0,80</b>	Pz2-50	<b>0,73</b>	Pz2-100	<b>0,67</b>
Pz 3	25	Pz3-2	<b>1,29</b>	Pz3-5	<b>0,80</b>	Pz3-50	<b>0,73</b>	Pz3-100	<b>0,67</b>

**PLAT**

€ x Embout	L1 mm	2 Unités		5 Unités		50 Unités		100 Unités	
			€		€		€		€
0,5X3,0	25	P0,5X3,0-2	<b>1,72</b>	P0,5X3,0-5	<b>1,50</b>	P0,5X3,0-50	<b>1,36</b>	P0,5X3,0-100	<b>1,28</b>
0,6X3,5	25	P0,6X3,5-2	<b>1,72</b>	P0,6X3,5-5	<b>1,50</b>	P0,6X3,5-50	<b>1,36</b>	P0,6X3,5-100	<b>1,28</b>
0,5X4,0	25	P0,5X4,0-2	<b>1,72</b>	P0,5X4,0-5	<b>1,50</b>	P0,5X4,0-50	<b>1,36</b>	P0,5X4,0-100	<b>1,28</b>
0,6X4,5	25	P0,6X4,5-2	<b>1,72</b>	P0,6X4,5-5	<b>1,50</b>	P0,6X4,5-50	<b>1,36</b>	P0,6X4,5-100	<b>1,28</b>
0,8X4,0	25	P0,8X4,0-2	<b>1,72</b>	P0,8X4,0-5	<b>1,50</b>	P0,8X4,0-50	<b>1,36</b>	P0,8X4,0-100	<b>1,28</b>
0,8X5,0	25	P0,8X5,0-2	<b>1,72</b>	P0,8X5,0-5	<b>1,50</b>	P0,8X5,0-50	<b>1,36</b>	P0,8X5,0-100	<b>1,28</b>
0,8X5,5	25	P0,8X5,5-2	<b>1,72</b>	P0,8X5,5-5	<b>1,50</b>	P0,8X5,5-50	<b>1,36</b>	P0,8X5,5-100	<b>1,28</b>
1,0X5,5	25	P1X5,5-2	<b>1,72</b>	P1X5,5-5	<b>1,50</b>	P1X5,5-50	<b>1,36</b>	P1X5,5-100	<b>1,28</b>
1,0X6,0	25	P1X6,0-2	<b>1,72</b>	P1X6,0-5	<b>1,50</b>	P1X6,0-50	<b>1,36</b>	P1X6,0-100	<b>1,28</b>
1,2X6,5	25	P1,2X6,5-2	<b>1,72</b>	P1,2X6,5-5	<b>1,50</b>	P1,2X6,5-50	<b>1,36</b>	P1,2X6,5-100	<b>1,28</b>
1,2X8,0	25	P1,2X8,0-2	<b>1,72</b>	P1,2X8,0-5	<b>1,50</b>	P1,2X8,0-50	<b>1,36</b>	P1,2X8,0-100	<b>1,28</b>

**EMBOUS DE VISSAGE**



25mm  
LONGUEUR  
TOTALE  
(L<sub>1</sub>)

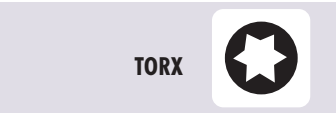

€ x Embout		2 Unités		5 Unités		50 Unités		100 Unités	
	L1 mm		€		€		€		€
T5	25	PT5-2	2,28	PT5-5	1,98	PT5-50	1,78	PT5-100	1,68
T6	25	PT6-2	2,28	PT6-5	1,98	PT6-50	1,78	PT6-100	1,68
T7	25	PT7-2	2,28	PT7-5	1,98	PT7-50	1,78	PT7-100	1,68
T8	25	PT8-2	2,28	PT8-5	1,98	PT8-50	1,78	PT8-100	1,68
T9	25	PT9-2	2,28	PT9-5	1,98	PT9-50	1,78	PT9-100	1,68
T10	25	PT10-2	1,87	PT10-5	1,46	PT10-50	1,31	PT10-100	1,23
T15	25	PT15-2	1,87	PT15-5	1,46	PT15-50	1,31	PT15-100	1,23
T20	25	PT20-2	1,87	PT20-5	1,46	PT20-50	1,31	PT20-100	1,23
T25	25	PT25-2	1,87	PT25-5	1,46	PT25-50	1,31	PT25-100	1,23
T27	25	PT27-2	1,87	PT27-5	1,46	PT27-50	1,31	PT27-100	1,23
T30	25	PT30-2	1,87	PT30-5	1,46	PT30-50	1,31	PT30-100	1,23
T40	25	PT40-2	1,87	PT40-5	1,46	PT40-50	1,31	PT40-100	1,23

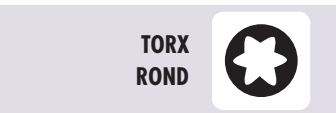

€ x Embout		2 Unités		5 Unités		50 Unités		100 Unités	
	L1 mm		€		€		€		€
TR10	25	PTR10-2	6,07	PTR10-5	5,26	PTR10-50	4,74	PTR10-100	4,46
TR15	25	PTR15-2	6,07	PTR15-5	5,26	PTR15-50	4,74	PTR15-100	4,46
TR20	25	PTR20-2	6,07	PTR20-5	5,26	PTR20-50	4,74	PTR20-100	4,46
TR25	25	PTR25-2	6,07	PTR25-5	5,26	PTR25-50	4,74	PTR25-100	4,46
TR30	25	PTR30-2	6,07	PTR30-5	5,26	PTR30-50	4,74	PTR30-100	4,46
TR40	25	PTR40-2	6,07	PTR40-5	5,26	PTR40-50	4,74	PTR40-100	4,46

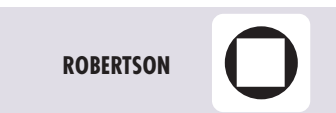

€ x Embout		2 Unités		5 Unités		50 Unités		100 Unités	
	L1 mm		€		€		€		€
N°1	25	PC1-2	2,44	PC1-5	2,13	PC1-50	1,91	PC1-100	1,81
N°2	25	PC2-2	2,44	PC2-5	2,13	PC2-50	1,91	PC2-100	1,81
N°3	25	PC3-2	2,44	PC3-5	2,13	PC3-50	1,91	PC3-100	1,81

**EMBOUTS DE VISSAGE**
**Plus**

**25mm**  
 LONGUEUR  
 TOTALE  
 (L)

**TORX  
SÉCURITÉ**

€ x Embout		2 Unités		5 Unités		50 Unités		100 Unités	
	L1 mm		€		€		€		€
TS10	25	PTS10-2	<b>3,24</b>	PTS10-5	<b>2,82</b>	PTS10-50	<b>2,54</b>	PTS10-100	<b>2,40</b>
TS15	25	PTS15-2	<b>3,24</b>	PTS15-5	<b>2,82</b>	PTS15-50	<b>2,54</b>	PTS15-100	<b>2,40</b>
TS20	25	PTS20-2	<b>3,24</b>	PTS20-5	<b>2,82</b>	PTS20-50	<b>2,54</b>	PTS20-100	<b>2,40</b>
TS25	25	PTS25-2	<b>3,24</b>	PTS25-5	<b>2,82</b>	PTS25-50	<b>2,54</b>	PTS25-100	<b>2,40</b>
TS27	25	PTS27-2	<b>3,24</b>	PTS27-5	<b>2,82</b>	PTS27-50	<b>2,54</b>	PTS27-100	<b>2,40</b>
TS30	25	PTS30-2	<b>3,24</b>	PTS30-5	<b>2,82</b>	PTS30-50	<b>2,54</b>	PTS30-100	<b>2,40</b>
TS40	25	PTS40-2	<b>3,24</b>	PTS40-5	<b>2,82</b>	PTS40-50	<b>2,54</b>	PTS40-100	<b>2,40</b>

**HEXAGONAL**

€ x Embout		2 Unités		5 Unités		50 Unités		100 Unités	
	L1 mm		€		€		€		€
2 mm	25	PHX2-2	<b>1,80</b>	PHX2-5	<b>1,63</b>	PHX2-50	<b>1,45</b>	PHX2-100	<b>1,40</b>
2,5 mm	25	PHX2,5-2	<b>1,80</b>	PHX2,5-5	<b>1,63</b>	PHX2,5-50	<b>1,45</b>	PHX2,5-100	<b>1,40</b>
3 mm	25	PHX3-2	<b>1,80</b>	PHX3-5	<b>1,63</b>	PHX3-50	<b>1,45</b>	PHX3-100	<b>1,40</b>
4 mm	25	PHX4-2	<b>1,80</b>	PHX4-5	<b>1,63</b>	PHX4-50	<b>1,45</b>	PHX4-100	<b>1,40</b>
5 mm	25	PHX5-2	<b>1,80</b>	PHX5-5	<b>1,63</b>	PHX5-50	<b>1,45</b>	PHX5-100	<b>1,40</b>
6 mm	25	PHX6-2	<b>1,80</b>	PHX6-5	<b>1,63</b>	PHX6-50	<b>1,45</b>	PHX6-100	<b>1,40</b>
8 mm	25	PHX8-2	<b>2,13</b>	PHX8-5	<b>1,93</b>	PHX8-50	<b>1,84</b>	PHX8-100	<b>1,76</b>

**TRI  
WING**

€ x Embout		2 Unités		5 Unités		50 Unités		100 Unités	
	L1 mm		€		€		€		€
N°4	25	PTRW4-2	<b>10,72</b>	PTRW4-5	<b>9,32</b>	PTRW4-50	<b>8,39</b>	PTRW4-100	<b>7,92</b>
N°5	25	PTRW5-2	<b>10,72</b>	PTRW5-5	<b>9,32</b>	PTRW5-50	<b>8,39</b>	PTRW5-100	<b>7,92</b>
N°6	25	PTRW6-2	<b>10,72</b>	PTRW6-5	<b>9,32</b>	PTRW6-50	<b>8,39</b>	PTRW6-100	<b>7,92</b>
N°8	25	PTRW8-2	<b>10,72</b>	PTRW8-5	<b>9,32</b>	PTRW8-50	<b>8,39</b>	PTRW8-100	<b>7,92</b>

**XZN**

€ x Embout		2 Unités		5 Unités		50 Unités		100 Unités	
	L1 mm		€		€		€		€
N°4	25	PXZN4-2	<b>6,58</b>	PXZN4-5	<b>5,72</b>	PXZN4-50	<b>5,14</b>	PXZN4-100	<b>4,86</b>
N°5	25	PXZN5-2	<b>6,58</b>	PXZN5-5	<b>5,72</b>	PXZN5-50	<b>5,14</b>	PXZN5-100	<b>4,86</b>
N°6	25	PXZN6-2	<b>6,58</b>	PXZN6-5	<b>5,72</b>	PXZN6-50	<b>5,14</b>	PXZN6-100	<b>4,86</b>
N°8	25	PXZN8-2	<b>7,51</b>	PXZN8-5	<b>6,53</b>	PXZN8-50	<b>6,41</b>	PXZN8-100	<b>6,29</b>
N°10	25	PXZN10-2	<b>7,51</b>	PXZN10-5	<b>6,53</b>	PXZN10-50	<b>6,41</b>	PXZN10-100	<b>6,29</b>

**EMBOUTS DE VISSAGE**



€ x Embout		2 Unités		5 Unités		50 Unités	
	L1 mm		€		€		€
Ph 1	50	Ph1X50-2	<b>2,94</b>	Ph1X50-5	<b>2,56</b>	Ph1X50-50	<b>2,31</b>
Ph 2	50	Ph2X50-2	<b>2,94</b>	Ph2X50-5	<b>2,56</b>	Ph2X50-50	<b>2,31</b>
Ph 3	50	Ph3X50-2	<b>2,94</b>	Ph3X50-5	<b>2,56</b>	Ph3X50-50	<b>2,31</b>
Ph 4	50	Ph4X50-2	-	Ph4X50-5	-	Ph4X50-50	-

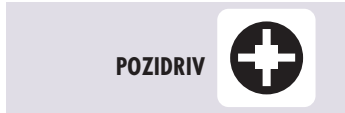

€ x Embout		2 Unités		5 Unités		50 Unités	
	L1 mm		€		€		€
Pz 1	50	Pz1X50-2	<b>2,94</b>	Pz1X50-5	<b>2,56</b>	Pz1X50-50	<b>2,31</b>
Pz 2	50	Pz2X50-2	<b>2,94</b>	Pz2X50-5	<b>2,56</b>	Pz2X50-50	<b>2,31</b>
Pz 3	50	Pz3X50-2	<b>2,94</b>	Pz3X50-5	<b>2,56</b>	Pz3X50-50	<b>2,31</b>
Pz 4	50	Pz4X50-2	-	Pz4X50-5	-	Pz4X50-50	-



€ x Embout		2 Unités		5 Unités		50 Unités	
	L1 mm		€		€		€
0,5X4,0	50	P0,5X4,0X50-2	<b>4,60</b>	P0,5X4,0X50-5	<b>3,99</b>	P0,5X4,0X50-50	<b>3,57</b>
0,5X3,0	50	P0,5X3,0X50-2	<b>4,60</b>	P0,5X3,0X50-5	<b>3,99</b>	P0,5X3,0X50-50	<b>3,57</b>
0,6X3,5	50	P0,6X3,5X50-2	<b>4,60</b>	P0,6X3,5X50-5	<b>3,99</b>	P0,6X3,5X50-50	<b>3,57</b>
0,6X4,5	50	P0,6X4,5X50-2	<b>4,60</b>	P0,6X4,5X50-5	<b>3,99</b>	P0,6X4,5X50-50	<b>3,57</b>
0,8X4,0	50	P0,8X4,0X50-2	<b>4,60</b>	P0,8X4,0X50-5	<b>3,99</b>	P0,8X4,0X50-50	<b>3,57</b>
0,8X5,0	50	P0,8X5,0X50-2	<b>4,60*</b>	P0,8X5,0X50-5	<b>3,99*</b>	P0,8X5,0X50-50	<b>3,57*</b>
0,8X5,5	50	P0,8X5,5X50-2	<b>4,60</b>	P0,8X5,5X50-5	<b>3,99</b>	P0,8X5,5X50-50	<b>3,57</b>
1,0X5,5	50	P1X5,5X50-2	<b>4,60</b>	P1X5,5X50-5	<b>3,99</b>	P1X5,5X50-50	<b>3,57</b>
1,0X6,0	50	P1X6,0X50-2	<b>4,60</b>	P1X6,0X50-5	<b>3,99</b>	P1X6,0X50-50	<b>3,57</b>
1,2X6,5	50	P1,2X6,5X50-2	<b>4,60</b>	P1,2X6,5X50-5	<b>3,99</b>	P1,2X6,5X50-50	<b>3,57</b>
1,2X8,0	50	P1,2X8,0X50-2	<b>4,60</b>	P1,2X8,0X50-5	<b>3,99</b>	P1,2X8,0X50-50	<b>3,57</b>

\*jusque fin des stocks

**EMBOUTS DE VISSAGE**
**Plus**

**50mm**  
 LONGUEUR  
 TOTALE  
 (L)

**TORX**

€ x Embout		2 Unités		5 Unités		50 Unités	
	L1 mm		€		€		€
T 5	50	PT5X50-2	<b>5,88</b>	PT5X50-5	<b>5,12</b>	PT5X50-50	<b>4,63</b>
T 6	50	PT6X50-2	<b>5,88</b>	PT6X50-5	<b>5,12</b>	PT6X50-50	<b>4,63</b>
T 7	50	PT7X50-2	<b>5,88</b>	PT7X50-5	<b>5,12</b>	PT7X50-50	<b>4,63</b>
T 8	50	PT8X50-2	<b>5,88</b>	PT8X50-5	<b>5,12</b>	PT8X50-50	<b>4,63</b>
T 9	50	PT9X50-2	<b>5,88</b>	PT9X50-5	<b>5,12</b>	PT9X50-50	<b>4,63</b>
T 10	50	PT10X50-2	<b>5,42</b>	PT10X50-5	<b>4,90</b>	PT10X50-50	<b>4,24</b>
T 15	50	PT15X50-2	<b>5,42</b>	PT15X50-5	<b>4,90</b>	PT15X50-50	<b>4,24</b>
T 20	50	PT20X50-2	<b>5,42</b>	PT20X50-5	<b>4,90</b>	PT20X50-50	<b>4,24</b>
T 25	50	PT25X50-2	<b>5,42</b>	PT25X50-5	<b>4,90</b>	PT25X50-50	<b>4,24</b>
T 27	50	PT27X50-2	<b>5,42</b>	PT27X50-5	<b>4,90</b>	PT27X50-50	<b>4,24</b>
T 30	50	PT30X50-2	<b>5,42</b>	PT30X50-5	<b>4,90</b>	PT30X50-50	<b>4,24</b>
T 40	50	PT40X50-2	<b>5,42</b>	PT40X50-5	<b>4,90</b>	PT40X50-50	<b>4,24</b>

**ROBERTSON**

€ x Embout		2 Unités		5 Unités		50 Unités	
	L1 mm		€		€		€
N°1	50	PC1X50-2	<b>7,07</b>	PC1X50-5	<b>6,14</b>	PC1X50-50	<b>5,53</b>
N°2	50	PC2X50-2	<b>7,07</b>	PC2X50-5	<b>6,14</b>	PC2X50-50	<b>5,53</b>
N°3	50	PC3X50-2	<b>7,07</b>	PC3X50-5	<b>6,14</b>	PC3X50-50	<b>5,53</b>

**HEXAGONAL**



€ x Embout		2 Unités		5 Unités		50 Unités	
	L1 mm		€		€		€
2 mm	50	PHX2X50-2	<b>5,72</b>	PHX2X50-5	<b>4,97</b>	PHX2X50-50	<b>4,48</b>
2,5 mm	50	PHX2,5X50-2	<b>5,72</b>	PHX2,5X50-5	<b>4,97</b>	PHX2,5X50-50	<b>4,48</b>
3 mm	50	PHX3X50-2	<b>5,72</b>	PHX3X50-5	<b>4,97</b>	PHX3X50-50	<b>4,48</b>
4 mm	50	PHX4X50-2	<b>5,72</b>	PHX4X50-5	<b>4,97</b>	PHX4X50-50	<b>4,48</b>
5 mm	50	PHX5X50-2	<b>5,72</b>	PHX5X50-5	<b>4,97</b>	PHX5X50-50	<b>4,48</b>
6 mm	50	PHX6X50-2	<b>5,72</b>	PHX6X50-5	<b>4,97</b>	PHX6X50-50	<b>4,48</b>
8 mm	50	PHX8X50-2	<b>7,33</b>	PHX8X50-5	<b>6,71</b>	PHX8X50-50	<b>5,74</b>



**EMBOUS DE VISSAGE**

**Plus** ★★ **70mm** LONGUEUR TOTALE (L<sub>1</sub>)



**PHILLIPS** 



€ x Embout		2 Unités		5 Unités	
	L1 mm		€		€
Ph 1	70	Ph1X70-2	<b>6,90</b>	Ph1X70-5	<b>6,01</b>
Ph 2	70	Ph2X70-2	<b>6,90</b>	Ph2X70-5	<b>6,01</b>
Ph 3	70	Ph3X70-2	<b>6,90</b>	Ph3X70-5	<b>6,01</b>
Ph 4	70	Ph4X70-2	-	Ph4X70-5	-

**POZIDRIV** 



€ x Embout		2 Unités		5 Unités	
	L1 mm		€		€
Pz 1	70	Pz1X70-2	<b>6,90</b>	Pz1X70-5	<b>6,01</b>
Pz 2	70	Pz2X70-2	<b>6,90</b>	Pz2X70-5	<b>6,01</b>
Pz 3	70	Pz3X70-2	<b>6,90</b>	Pz3X70-5	<b>6,01</b>
Pz 4	70	Pz4X70-2	-	Pz4X70-5	-

**Plus** ★★ **90mm** LONGUEUR TOTALE (L<sub>1</sub>)



**PHILLIPS** 



€ x Embout		2 Unités		5 Unités	
	L1 mm		€		€
Ph 1	90	Ph1X90-2	<b>8,51</b>	Ph1X90-5	<b>7,40</b>
Ph 2	90	Ph2X90-2	<b>8,51</b>	Ph2X90-5	<b>7,40</b>
Ph 3	90	Ph3X90-2	<b>8,51</b>	Ph3X90-5	<b>7,40</b>
Ph 4	90	Ph4X90-2	-	Ph4X90-5	-

**POZIDRIV** 



€ x Embout		2 Unités		5 Unités	
	L1 mm		€		€
Pz 1	90	Pz1X90-2	<b>8,51</b>	Pz1X90-5	<b>7,40</b>
Pz 2	90	Pz2X90-2	<b>8,51</b>	Pz2X90-5	<b>7,40</b>
Pz 3	90	Pz3X90-2	<b>8,51</b>	Pz3X90-5	<b>7,40</b>
Pz 4	90	Pz4X90-2	-	Pz4X90-5	-

**EMBOUTS DE VISSAGE**
**TiN**

**25mm**  
 LONGUEUR  
 TOTALE  
 (L<sub>1</sub>)

**PHILLIPS**

€ x Embout		2 Unités		5 Unités		50 Unités	
	L1 mm		€		€		€
Ph 1	25	Ph1T-2	<b>3,48</b>	Ph1T-5	<b>2,62</b>	Ph1T-50	<b>2,36</b>
Ph 2	25	Ph2T-2	<b>3,48</b>	Ph2T-5	<b>2,62</b>	Ph2T-50	<b>2,36</b>
Ph 3	25	Ph3T-2	<b>3,48</b>	Ph3T-5	<b>2,62</b>	Ph3T-50	<b>2,36</b>

**POZIDRIV**

€ x Embout		2 Unités		5 Unités		50 Unités	
	L1 mm		€		€		€
Pz 1	25	Pz1T-2	<b>3,48</b>	Pz1T-5	<b>2,62</b>	Pz1T-50	<b>2,36</b>
Pz 2	25	Pz2T-2	<b>3,48</b>	Pz2T-5	<b>2,62</b>	Pz2T-50	<b>2,36</b>
Pz 3	25	Pz3T-2	<b>3,48</b>	Pz3T-5	<b>2,62</b>	Pz3T-50	<b>2,36</b>

**PLAT**

€ x Embout		2 Unités		5 Unités		50 Unités	
	L1 mm		€		€		€
0,6X4,5	25	PO,6X4,5T-2	<b>3,72</b>	PO,6X4,5T-5	<b>3,23</b>	PO,6X4,5T-50	<b>2,90</b>
0,8X5,5	25	PO,8X5,5T-2	<b>3,72</b>	PO,8X5,5T-5	<b>3,23</b>	PO,8X5,5T-50	<b>2,90</b>
1,0X5,5	25	P1X5,5T-2	<b>3,72</b>	P1X5,5T-5	<b>3,23</b>	P1X5,5T-50	<b>2,90</b>
1,2X6,5	25	P1,2X6,5T-2	<b>3,72</b>	P1,2X6,5T-5	<b>3,23</b>	P1,2X6,5T-50	<b>2,90</b>

**TORX**

€ x Embout		2 Unités		5 Unités		50 Unités	
	L1 mm		€		€		€
T 10	25	PT10T-2	<b>3,66</b>	PT10T-5	<b>3,19</b>	PT10T-50	<b>2,87</b>
T 15	25	PT15T-2	<b>3,66</b>	PT15T-5	<b>3,19</b>	PT15T-50	<b>2,87</b>
T 20	25	PT20T-2	<b>3,66</b>	PT20T-5	<b>3,19</b>	PT20T-50	<b>2,87</b>
T 25	25	PT25T-2	<b>3,66</b>	PT25T-5	<b>3,19</b>	PT25T-50	<b>2,87</b>
T 27	25	PT27T-2	<b>3,66</b>	PT27T-5	<b>3,19</b>	PT27T-50	<b>2,87</b>
T 30	25	PT30T-2	<b>3,66</b>	PT30T-5	<b>3,19</b>	PT30T-50	<b>2,87</b>
T 40	25	PT40T-2	<b>3,66</b>	PT40T-5	<b>3,19</b>	PT40T-50	<b>2,87</b>



**EMBOUTS DE VISSAGE**

**TiN**



**50mm**  
LONGUEUR  
TOTALE  
(L)



**PHILLIPS**



€ x Embout		2 Unités		5 Unités		50 Unités	
	L1 mm		€		€		€
Ph 1	50	Ph1Tx50-2	<b>8,01</b>	Ph1Tx50-5	<b>6,97</b>	Ph1Tx50-50	<b>6,25</b>
Ph 2	50	Ph2Tx50-2	<b>8,01</b>	Ph2Tx50-5	<b>6,97</b>	Ph2Tx50-50	<b>6,25</b>
Ph 3	50	Ph3Tx50-2	<b>8,01</b>	Ph3Tx50-5	<b>6,97</b>	Ph3Tx50-50	<b>6,25</b>

**POZIDRIV**



€ x Embout		2 Unités		5 Unités		50 Unités	
	L1 mm		€		€		€
Pz 1	50	Pz1Tx50-2	<b>8,01</b>	Pz1Tx50-5	<b>6,97</b>	Pz1Tx50-50	<b>6,25</b>
Pz 2	50	Pz2Tx50-2	<b>8,01</b>	Pz2Tx50-5	<b>6,97</b>	Pz2Tx50-50	<b>6,25</b>
Pz 3	50	Pz3Tx50-2	<b>8,01</b>	Pz3Tx50-5	<b>6,97</b>	Pz3Tx50-50	<b>6,25</b>

**TORX**



€ x Embout		2 Unités		5 Unités		50 Unités	
	L1 mm		€		€		€
T 10	50	PT10Tx50-2	<b>11,36</b>	PT10Tx50-5	<b>9,87</b>	PT10Tx50-50	<b>8,87</b>
T 15	50	PT15Tx50-2	<b>11,36</b>	PT15Tx50-5	<b>9,87</b>	PT15Tx50-50	<b>8,87</b>
T 20	50	PT20Tx50-2	<b>11,36</b>	PT20Tx50-5	<b>9,87</b>	PT20Tx50-50	<b>8,87</b>
T 25	50	PT25Tx50-2	<b>11,36</b>	PT25Tx50-5	<b>9,87</b>	PT25Tx50-50	<b>8,87</b>
T 27	50	PT27Tx50-2	<b>11,36</b>	PT27Tx50-5	<b>9,87</b>	PT27Tx50-50	<b>8,87</b>
T 30	50	PT30Tx50-2	<b>11,36</b>	PT30Tx50-5	<b>9,87</b>	PT30Tx50-50	<b>8,87</b>
T 40	50	PT40Tx50-2	<b>11,36</b>	PT40Tx50-5	<b>9,87</b>	PT40Tx50-50	<b>8,87</b>

## PORTE-EMBOUTS

### PORTE-EMBOUTS MAGNÉTIQUES

	L1 mm	TYPE DE QUEUE	€
PMGx51	51	MAGNÉTIQUE SANS ANNEAU	6,63
PMGx58	58	MAGNÉTIQUE SANS ANNEAU	6,80
PMGx74	74	MAGNÉTIQUE AVEC ANNEAU	11,74
PMGx100	100	MAGNÉTIQUE AVEC ANNEAU	13,56
PMGx150	150	MAGNÉTIQUE AVEC ANNEAU	16,28
PMGx200	200	MAGNÉTIQUE AVEC ANNEAU	17,88
PMGx250	250	MAGNÉTIQUE AVEC ANNEAU	27,49
PMGSDSx78	78	SDS PLUS	20,03
PBERx74	74	BÉRYLIUM	50,41*
PDESSx70	70	5/16" DESSOUTTER	31,06*
P7x74	74	7mm Fein	33,75*

\*jusque fin des stocks



### PORTE-EMBOUTS MAGNÉTIQUES À CHANGEMENT RAPIDE (VALABLE POUR EMBOUTS DE 1/4" À COU)

	L1 mm	TYPE DE QUEUE	€
PCR60	60	Changement rapide 1/4" Valable pour embouts 1/4"	17,45
PCR74	74	Changement rapide 1/4" Valable pour embouts 1/4"	18,00
PCRSDSx80	80	SDS PLUS	29,21



### PORTE-EMBOUTS MAGNÉTIQUES AVEC ANNEAU FRONTAL MAGNÉTIQUE SUPPLÉMENTAIRE POUR LE MAINTIEN DES VIS

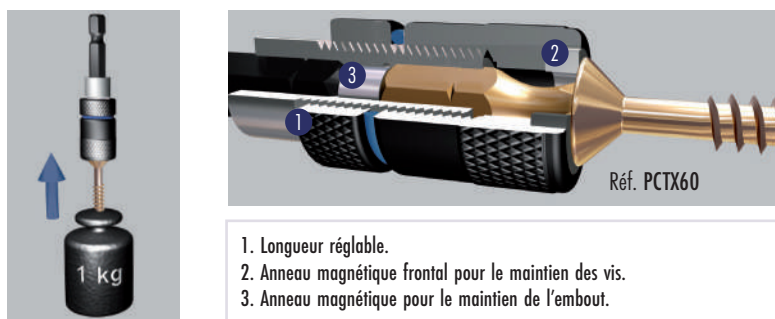

	L1 mm	TYPE PORTE-EMBOUTS	€
PCTX60	60	Avec butoir réglable	16,44



**DOUILLES HEXAGONALES MAGNÉTIQUES**



50mm  
LONGUEUR  
TOTALE  
(L<sub>1</sub>)

**DOUILLE HEXAGONALE MAGNÉTIQUE**



	mm	"		€/10.
PLIHX5-2	5,0		2	6,41
PLIHX5,5-2	5,5		2	6,41
PLIHX6-2	6,0		2	6,41
PLIHX1/4-2		1/4"=6,35	2	6,41
PLIHX7-2	7,0		2	6,57
PLIHX5/16-2		5/16"=7,93	2	6,57
PLIHX8-2	8,0		2	6,57
PLIHX3/8-2		3/8"=9,52	2	6,57
PLIHX10-2	10,0		2	6,71
PLIHX11-2	11,0		2	6,71
PLIHX12-2	12,0		2	6,84
PLIHX13-2	13,0		2	6,90

**COFFRET DE 7 DOUILLES HEXAGONALES**

RÉFÉRENCE	<b>EPLL</b>
N° DOUILLE	7
CONTENU	HX1/4 - HX7 - HX8 - HX3/8 HX10 - HX12 - HX13
PRIX €	<b>46,19</b>



**TOURNEVIS À CLIQUET AVEC MAGASIN POUR EMBOUTS**



1. Haute qualité et rendement
2. Visse à droite et à gauche
3. Tige télescopique ajustable en longueur
4. Fabriqué en acier et plastique haute résistance

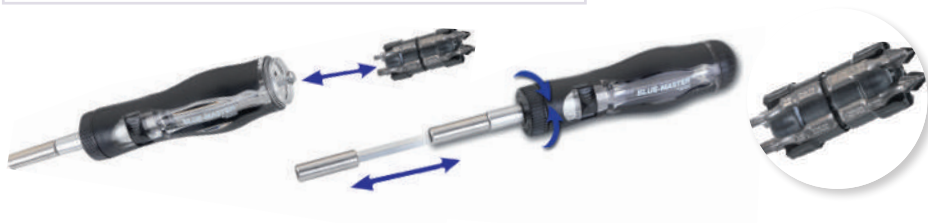
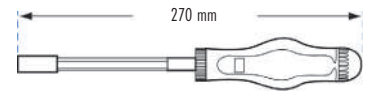
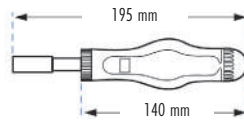

**DTRC**

- Contenu du tournevis
- PH1 - PH2
  - PZ1 - PZ2
  - T15 - T20 - T25 - T30

**35,10 €**

**COFFRETS D'EMBOUS DE VISSAGE**

**COFFRETS DE 7 PIÈCES QUALITÉ PLUS ET TiN**



Réf. EPT1





RÉFÉRENCE	EPT1	EPT2	EPT3
N° EMBOUTS	7	7	7
CONTENU	PH1 - PH2 PZ1 - PZ2 0,8x5,5 - 1,2x6,5 1 Porte-embouts PMG	T10 - T15 T20 - T25 T30 - T40 1 Porte-embouts PMG	PH1 - PH2 - PH3 PZ1 - PZ2 - PZ3 1 Porte-embouts PMG
PRIX €	<b>12,20</b>	<b>16,45</b>	<b>14,64</b>







Réf. EPTT1

RÉFÉRENCE	EPTT1	EPTT2	EPTT3
N° EMBOUTS	7	7	7
CONTENU	PH1 - PH2 PZ1 - PZ2 0,8x5,5 - 1,2x6,5 1 Porte-embouts PMG	T10 - T15 T20 - T25 T30 - T40 1 Porte-embouts PMG	PH1 - PH2 - PH3 PZ1 - PZ2 - PZ3 1 Porte-embouts PMG
PRIX €	<b>34,64</b>	<b>40,16</b>	<b>33,41</b>





**COFFRETS D'EMBOUS DE VISSAGE**
**COFFRETS DE 12 PIÈCES QUALITÉ PLUS ET TiN**

		EPT4		EPT5	
 Réf. EPT4	RÉFÉRENCE				
	N° EMOUS	12		12	
 <b>Plus</b>	CONTENU	+ PH1 - PH2(2) - PH3 + PZ1 - PZ2(2) - PZ3 - 0,6x4,5 - 0,8x5,5 - 1,2x6,5 1 Porte-embois PMG		★ T10 - T15(2) ★ T20(2) - T25(2) T27 - T30(2) - T40 1 Porte-embois PMG	
	PRIX €	16,38		22,49	
 Réf. EPT4	RÉFÉRENCE				
	N° EMOUS	12		12	
 <b>TiN</b>	CONTENU	+ PH1 - PH2(2) - PH3 + PZ1 - PZ2(2) - PZ3 - 0,6x4,5 - 0,8x5,5 - 1,2x6,5 1 Porte-embois PCT		★ T10 - T15(2) ★ T20(2) - T25(2) T27 - T30(2) - T40 1 Porte-embois PCT	
	PRIX €	43,61		51,32	

**COFFRETS DE 31 PIÈCES QUALITÉ PLUS ET TiN**

		EPT6		EPT6	
 Réf. EPT6	RÉFÉRENCE				
	N° EMOUS	31		31	
 <b>Plus</b>	CONTENU	+ PH1(3) - PH2(3) - PH3(3) + PZ1(3) - PZ2(3) - PZ3(3) - 0,6x4,5 - 0,8x5,5 - 1,2x6,5		★ T10 - T15 - T20 - T25 - T30 - T40 ○ H3 - H4 - H5 1 Porte-embois PMG	
	PRIX €	46,81			
 <b>TiN</b>	RÉFÉRENCE				
	N° EMOUS	31		31	
 <b>TiN</b>	CONTENU	+ PH1(3) - PH2(3) - PH3(3) + PZ1(3) - PZ2(3) - PZ3(3) - 0,6x4,5 - 0,8x5,5 - 1,2x6,5		★ T10 - T15 - T20 - T25 - T30 - T40 ○ H3 - H4 - H5 1 Porte-embois PCT	
	PRIX €	99,32			

**COFFRETS DE 36 PIÈCES QUALITÉ PLUS ET TiN**

		EPT7		EPT7	
 Réf. EPT7	RÉFÉRENCE				
	N° EMOUS	36		36	
 <b>Plus</b>	CONTENU	+ PH1(3) - PH2(3) - PH3(3) + PZ1(3) - PZ2(3) - PZ3(3) - 0,5 x 4 - 0,6 x 4,5 - 0,8 x 5 - 0,8 x 5,5 - 1 x 6 - 1,2 x 6,5 - 1,2 x 8 1 Porte-embois PMG		★ T10 - T15 - T20 - T25 - T27 - T30 - T40 ○ H2 - H2,5 - H3 - H4 - H5 - H6 - H8	
	PRIX €	59,28			
 Réf. EPT7	RÉFÉRENCE				
	N° EMOUS	36		36	
 <b>TiN</b>	CONTENU	+ PH1(3) - PH2(3) - PH3(3) + PZ1(3) - PZ2(3) - PZ3(3) - 0,5 x 4 - 0,6 x 4,5 - 0,8 x 5 - 0,8 x 5,5 - 1 x 6 - 1,2 x 6,5 - 1,2 x 8 1 Porte-embois PCT		★ T10 - T15 - T20 - T25 - T27 - T30 - T40 ○ H2 - H2,5 - H3 - H4 - H5 - H6 - H8	
	PRIX €	121,63*			

\*jusque fin des stocks

**COFFRETS D'EMBOUS DE VISSAGE**

COFFRETS DE 45 ET 80 PIÈCES QUALITÉ *Plus*



Réf. EPT45



Réf. EPT80



RÉFÉRENCE	EPT45			
N° EMBOUTS	45			
<div style="border: 1px solid black; padding: 5px; display: inline-block;"><i>Plus</i></div>	+	PH1(2) - PH2(2) - PH3(2)	⬡	Douilles Hexagonales (mm): 5 - 6 - 7 - 8 - 9 - 10 - 11 - 12 - 13 - 14
	+	PZ1(2) - PZ2(2) - PZ3(2)	⬡	1 Adaptateur pour douilles
	-	0,5x3-0,6x4,5-0,8x5,5(2)-1,2x6,5-1,6x8	⬡	1 Adaptateur pour Embouts
	⬡	H2,5 - H3 - H4 - H5 - H6 - H7	⬡	1 Porte-embouts Magnétique PCR
	⬡	T10 - T15 - T20 - T25 - T30 - T40	⬡	1 Clé à Cliquet de 72 dents 1 Tournevis
PRIX €	<b>148,32</b>			

RÉFÉRENCE	EPT80*			
N° EMBOUTS	80			
<div style="border: 1px solid black; padding: 5px; display: inline-block;"><i>Plus</i></div>	+	PH0 - PH1 - PH2(4) - PH3(2)	⬡	C0 - C1 - C2 - C3
	+	PZ1 - PZ2(4) - PZ3(2)	⬡	SP4 - SP6 - SP8 - SP10
	-	0,5x3-0,6x4,5-0,8x5,5(2)-1,2x6,5-1,6x8	⬡	HS3 - HS4 - HS5 - HS6
	⬡	H2 - H2,5 - H3 - H4 - H5 - H6 - H7 - H8	⬡	1 Porte-Embouts PCR
	⬡	TW1 - TW2 - TW3 - TW4 - TW5		1 Tournevis
	⬡	TQ5 - TQ6 - TQ8 - TQ10		
	⬡	T5 - T6 - T7 - T8 - T9 - T10 - T15 T20(2) - T25(2) - T27 - T30 - T40	+	PH1 - PH2
	⬡	TS10 - TS15 - TS20 - TS25 - TS30 - TS40	+	PZ1 - PZ2
		⬡	T15 - T20 - T25 - T30	
PRIX €	<b>155,24*</b>			

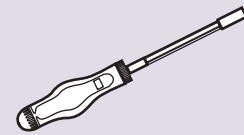

\*jusque fin des stocks

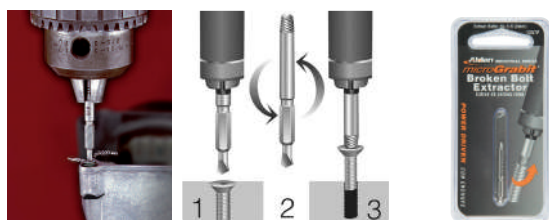

**EXTRACTEURS MACHINE POUR VIS CASSÉES**
**MICRO GRABIT**

		EP
		€
EP451C	M3	55,10
EP452C	M4	55,10
EP453C	M5	55,10
EP454C	M6	55,10

1. Percer la vis
2. Retourner
3. Extraire

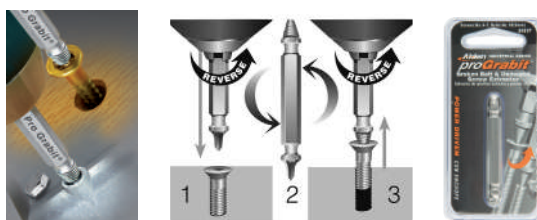
**PRO GRABIT À CORPS HEXAGONAL 1/4"**

		EP
		€
EP8401C	M5	43,70
EP8402C	M6	51,63
EP8403C	M8	51,63
EP8404C	M10	54,18

1. Percer la vis
2. Retourner
3. Extraire

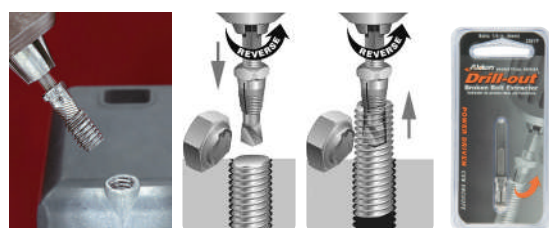
**DRILL-OUT EXTRACTEUR AVEC FORET PILOTE (M6-M12)**

		EP
		€
EP205C	M6	53,42
EP312C	M8	64,73
EP375C	M10	64,73
EP500C	M12	72,86

**X-OUT EXTRACTEUR À QUEUE HEXAGONALE (M3-M5)**

		EP
		€
EP3701C	M3	43,70
EP3702C	M4	43,70
EP3703C	M5	48,57

**COFFRETS D'EXTRACTEURS MACHINE POUR VIS CASSÉES**
**MICRO GRABIT**

RÉFÉRENCE	EP450C
N° PIÈCES	4
CONTENU	M3-M4-M5-M6
PRIX €	226,00

**MICRO GRABIT**

RÉFÉRENCE	EP401C
N° PIÈCES	4
CONTENU	M6-M8-M10-M12
PRIX €	265,87



**EXTRACTEURS DE VIS À MAIN**

**JEUX D'EXTRACTEURS CLASSIQUES DE VIS**

Faire un trou central avec le foret BLUE-MASTER recommandé.

Introduire l'extracteur dans le trou, tourner l'extracteur vers la gauche, jusqu'à extraction de la vis.

RÉFÉRENCE	EX/1-5	EX/1-6	EX/1-8
N° PIÈCES	5	6	8
CONTENU	M3 - M18	M3 - M24	M3 - M45
PRIX €	23,38	31,64	73,03



Réf. EX/1-6



	Pour VIS	mm	mm	L1 mm	Ø min mm	Ø max. mm	EX €
EX/1	M3 - M6	3,2	2,5	51	1,75	3,95	2,86
EX/2	M6 - M8	4,0	3,0	60	2,20	4,80	2,86
EX/3	M8 - M11	5,1	4,5	68	3,30	6,40	3,38
EX/4	M11 - M14	6,2	6,0	76	4,75	8,40	4,20
EX/5	M14 - M18	8,6	8,0	86	6,35	11,00	5,43
EX/6	M18 - M24	12,0	11,0	95	9,50	15,00	9,20
EX/7	M24 - M33	15,9	14,0	105	12,70	19,00	24,92
EX/8	M33 - M45	20,0	21,0	111	19,00	25,00	40,82



RÉFÉRENCE	EXTT
N° PIÈCES	10
EXTRACTEURS	EX/1-EX/2-EX/3-EX/4-EX/5
FORETS AVANT-TROUS	Réf. BC3 Ø2,5-3-4,5-6-8
PRIX €	38,27

**EXTRACTEURS DE VIS À MAIN**



	Pour VIS	mm	mm	L1 mm	Ø min mm	Ø max. mm	EFX €
EFX/1	M3-M6	2,9	2,0	50	1,9	3,2	3,60
EFX/2	M6-M8	3,9	3,2	60	2,8	5,0	3,60
EFX/3	M8-M11	4,8	4,0	68	3,2	6,5	4,26
EFX/4	M11-M14	6,7	6,4	75	5,2	9,0	5,29
EFX/5	M14-M18	8,5	7,1	85	6,4	11,0	6,89
EFX/6	M18-M25	11,8	9,5	95	9,4	15,0	11,64
EFX/7	M25-M35	14,3	12,7	106	12,8	19,0	31,53
EFX/8	M35-M45	19,5	19,5	110	19,3	25,0	51,65



Réf. EFX/1-5

RÉFÉRENCE	EFX/1-5
N° PIÈCES	5
CONTENU	M3 - M18
PRIX €	27,62

**FORETS POUR MÉTAUX DIN 338**

Réf. BH2

HSS



OX



	Ø mm	L1 x L2 mm	mm	BH2 €
BH20200	2,00	61 x 33	1/4"	6,26
BH20300	3,00	61 x 33	1/4"	6,26
BH20400	4,00	75 x 43	1/4"	6,50
BH20500	5,00	86 x 52	1/4"	8,09
BH20600	6,00	93 x 57	1/4"	8,73
BH20700	7,00	109 x 69	1/4"	10,99
BH20800	8,00	117 x 75	1/4"	12,35
BH20900	9,00	125 x 81	1/4"	13,89
BH21000	10,00	133 x 87	1/4"	15,46



RÉFÉRENCE	BH29335	BH29333
N° FORETS	5	8
QUALITÉ	HSS	HSS
CONTENU	Ø 3-4-5-6-8 mm	Ø 3-4-5-6-7-8-9-10 mm
PRIX €	53,15	71,10

**OUTILS À QUEUE HEXAGONALE DE 1/4"**
**FORETS POUR MÉTAUX EXTRA-COURT**
**HSS-G**

Réf. BC59

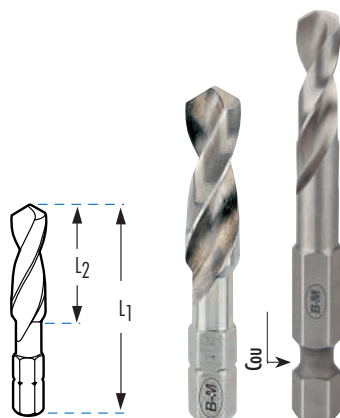
**FORET-TARAUD À CHANFREINER**
**HSS-G**

Réf. MAHM

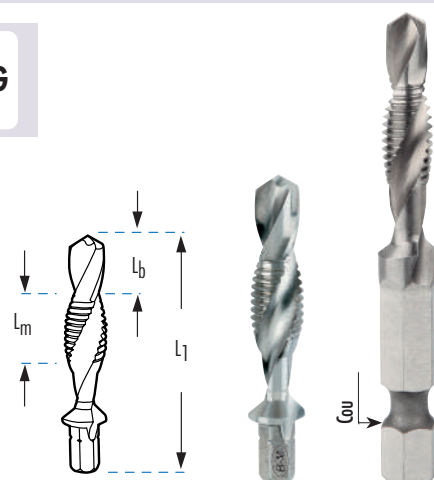

				BC59	BC59CR
	Ø mm	L1 x L2 mm		€	€
BC590100	1,00	34 x 12	1/4"	6,75	-
BC590150	1,50	34 x 12	1/4"	6,75	-
BC590200	2,00	34 x 12	1/4"	6,75	6,75
BC590250	2,50	36 x 14	1/4"	6,75	6,75
BC590300	3,00	38 x 16	1/4"	6,75	6,75
BC590330	3,30	40 x 18	1/4"	6,75	6,75
BC590350	3,50	40 x 18	1/4"	6,75	6,75
BC590400	4,00	44 x 20	1/4"	6,75	6,75
BC590420	4,20	45 x 20	1/4"	6,75	6,75
BC590450	4,50	46 x 24	1/4"	6,75	6,75
BC590500	5,00	50 x 26	1/4"	6,75	6,75
BC590550	5,50	50 x 26	1/4"	7,06	7,06
BC590600	6,00	50 x 26	1/4"	7,06	7,06
BC590650	6,50	50 x 30	1/4"	7,06	7,06
BC590680	6,80	50 x 30	1/4"	7,06	7,06
BC590700	7,00	50 x 30	1/4"	7,06	7,06
BC590750	7,50	51 x 32	1/4"	8,24	8,24
BC590800	8,00	51 x 32	1/4"	8,24	8,24
BC590850	8,50	53 x 33	1/4"	8,24	8,24
BC590900	9,00	53 x 33	1/4"	9,49	9,49
BC590950	9,50	54 x 38	1/4"	9,49	9,49
BC591000	10,00	54 x 38	1/4"	9,49	9,49
BC591020	10,20	54 x 38	1/4"	9,49	9,49

			MAHM	MAHMCr	
	L1 x Lb x Lm mm		€	€	
	M 3 x 0,50	36 x 5 x 6	1/4"	18,51	18,51
	M 4 x 0,70	39 x 6 x 7	1/4"	18,51	18,51
	M 5 x 0,80	41 x 8 x 8	1/4"	18,51	18,51
	M 6 x 1,00	44 x 8 x 10	1/4"	18,51	18,51
	M 8 x 1,25	50 x 10 x 11	1/4"	25,60	25,60
	M 10 x 1,50	59 x 11 x 11	1/4"	30,87	30,87



RÉFÉRENCE	MAH9327CR
N° FORETS	5
RÉFÉRENCE FORET	MAHMCr
CONTENU	M4-M5-M6-M8-M10
PRIX €	130,52

**TARAUDS HSS-G**
**HSS-G**

Réf. M

			M	MCR
	L1 x L2 mm		€	€
	M 3 x 0,50	33 x 11	7,10	7,10
	M 4 x 0,70	35 x 12	7,10	7,10
	M 5 x 0,80	36 x 15	9,04	9,04
	M 6 x 1,00	39 x 18	9,04	9,04
	M 8 x 1,25	40 x 19	12,53	12,53
	M 10 x 1,50	41 x 21	15,47	15,47

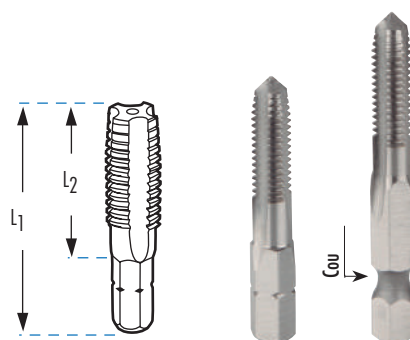

**OUTILS À QUEUE HEXAGONALE DE 1/4"**

**FORET-TARAUD HSSCo STEP CUT**

**NEW**

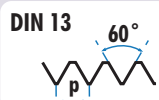

**HSSCo**  
5%

**BRILLANT**

**TOL**  
6H

**D**  
QUEUE  
DÉGAGÉE



Ref. MTKM

**STEP CUT**

										MTKM
		Lb	Lm	L3	L	Db	D2	D3		€
		mm	mm	mm	mm	mm	mm	mm	Hexagon	
M	3x0,50	D 7,0	6,0	6,0	57,0	2,5	2,2	7,3	1/4"	21,29
M	4x0,70	D 7,0	8,5	6,0	62,0	3,3	3,0	7,3	1/4"	21,29
M	5x0,80	D 9,0	10,0	6,0	69,0	4,2	3,7	7,3	1/4"	21,29
M	6x1,00	D 10,0	12,0	6,0	73,0	5,0	4,5	7,3	1/4"	21,29
M	8x1,25	D 12,0	16,0	6,0	87,0	6,8	6,3	9,4	1/4"	29,44
M	10x1,50	D 14,0	20,0	6,0	96,0	8,5	8,0	11,4	1/4"	35,50
M	12x1,75	D 16,0	24,0	8,0	112,0	10,3	9,8	13,4	1/4"	56,36

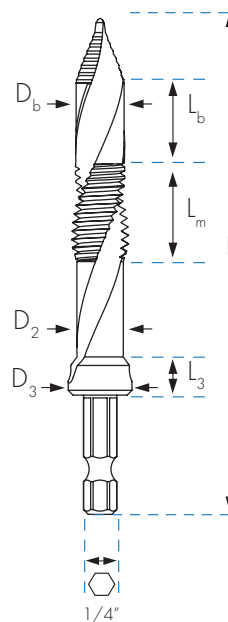

**FRAISES À CHANFREINER 3 GOUJURES**

**HSS-G**

Ref. AV22

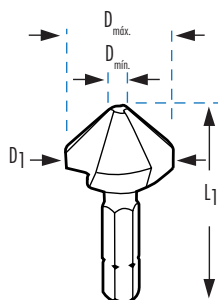

					AV22
D1	L1	D min. - D max.		€	
mm	mm	mm	Hexagon		
6,30	31	1,50 - 5,8	1/4"	17,85	
8,30	31	2,00 - 7,8	1/4"	17,85	
10,40	34	2,50 - 10,0	1/4"	19,14	
12,40	35	2,80 - 12,0	1/4"	20,41	
16,50	40	3,20 - 16,0	1/4"	22,83	
20,50	41	3,50 - 20,0	1/4"	25,06	

**FRAISES À ÉBAVURER**

**HSS**

Ref. AV1...CR

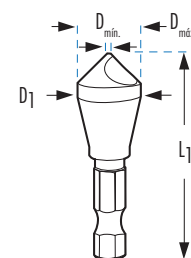

						AV1...CR
	D1	L1	D min. - D max.		€	
	mm	mm	mm	Hexagon		
Ref. AV101CR	10,00	40	2,0 - 5,0	1/4"	18,09	
Ref. AV102CR	14,00	42	5,0 - 10,0	1/4"	22,62	
Ref. AV103CR	17,00	45	5,0 - 13,0	1/4"	40,50	
Ref. AV104CR	25,00	55	7,0 - 20,0	1/4"	72,32	

**OUTILS À QUEUE HEXAGONALE DE 1/4"**
**FORETS BÉTON PROFESSIONNELS**

Réf. BWH

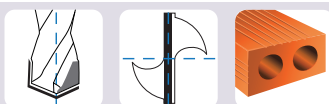

**MÈCHES À BOIS**

Réf. BMH

CV



BWH				
	Ø mm	L1 x L2 mm		€
BWH03	3	70 x 30	1/4"	3,16
BWH04	4	70 x 30	1/4"	3,42
BWH05	5	85 x 45	1/4"	3,71
BWH06	6	100 x 50	1/4"	4,14
BWH07	7	100 x 50	1/4"	4,85
BWH08	8	120 x 70	1/4"	5,63
BWH09	9	120 x 70	1/4"	6,71
BWH10	10	120 x 70	1/4"	7,53
BWH11	11	150 x 80	1/4"	9,37
BWH12	12	150 x 80	1/4"	10,59
BWH13	13	150 x 80	1/4"	13,02
BWH14	14	150 x 80	1/4"	15,16

BMH				
	Ø mm	L1 x L2 mm		€
BMH03	3	59 x 35	1/4"	2,02
BMH04	4	74 x 41	1/4"	2,14
BMH05	5	82 x 55	1/4"	2,11
BMH06	6	88 x 58	1/4"	2,85
BMH07	7	110 x 70	1/4"	3,22
BMH08	8	110 x 70	1/4"	3,37
BMH09	9	110 x 70	1/4"	3,50
BMH10	10	115 x 75	1/4"	3,87
BMH11	11	135 x 85	1/4"	4,52
BMH12	12	135 x 85	1/4"	5,29
BMH13	13	135 x 90	1/4"	8,28
BMH14	14	145 x 95	1/4"	10,32



RÉFÉRENCE	BWH9318	BWH9327	BWH9319	BMH9335	BMH9333
N° FORETS	5	5	8	5	8
APPLICATION	BÉTON	BÉTON	BÉTON	BOIS	BOIS
CONTENU	Ø 3 - 4 - 5 - 6 - 8 mm	Ø 4 - 5 - 6 - 8 - 10 mm	Ø 3 - 4 - 5 - 6 - 7 - 8 - 9 - 10 mm	Ø 3 - 4 - 5 - 6 - 8 mm	Ø 3 - 4 - 5 - 6 - 7 - 8 - 9 - 10 mm
PRIX €	27,28	32,92	37,70	16,93	22,33

**COFFRETS D'OUTILS À QUEUE HEXAGONALE DE 1/4"**

Réf. EB



Réf. EMBP

**CONTENU**

	 HSS-G	 HSS-G			€
EM	M3 - M4 - M5 - M6 M8 - M10	-	-	-	58,67
EMBP	M3 - M4 - M5 - M6 M8 - M10	Ø 2,50 - 3,30 - 4,20 5 - 6,80 - 8,50	-	-	94,86
EBM	-	-	M3 - M4 - M5 - M6 M8 - M10	-	124,26
EA	-	-	-	Ø 6,30 - 8,30 - 10,40 12,40 - 16,50 - 20,50	119,82
EB	-	Ø 1 - 10 mm x 0,50	-	-	131,42