

1/4" SHANK TOOLS

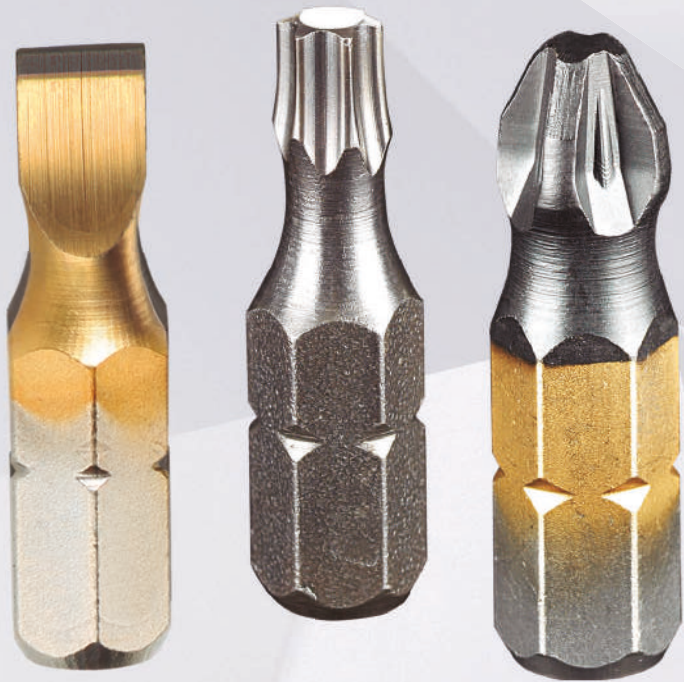

BLUE-MASTER[®]
by celesa

CUTTING TECHNOLOGIES

INTERCHANGEABLE SCREWDRIVER BITS



25mm
OVERALL
LENGTH
(L₁)



PHILLIPS



€ per Bit		2 U		5 U		50 U		100 U	
	L ₁ mm		€		€		€		€
Ph 0	25	Ph0-2	1,47	Ph0-5	1,29	Ph0-50	1,15	Ph0-100	1,10
Ph 1	25	Ph1-2	1,24	Ph1-5	0,77	Ph1-50	0,70	Ph1-100	0,64
Ph 2	25	Ph2-2	1,24	Ph2-5	0,77	Ph2-50	0,70	Ph2-100	0,64
Ph 3	25	Ph3-2	1,24	Ph3-5	0,77	Ph3-50	0,70	Ph3-100	0,64

POZIDRIV



€ per Bit		2 U		5 U		50 U		100 U	
	L ₁ mm		€		€		€		€
Pz 0	25	Pz0-2	1,47	Pz0-5	1,29	Pz0-50	1,15	Pz0-100	1,10
Pz 1	25	Pz1-2	1,24	Pz1-5	0,77	Pz1-50	0,70	Pz1-100	0,64
Pz 2	25	Pz2-2	1,24	Pz2-5	0,77	Pz2-50	0,70	Pz2-100	0,64
Pz 3	25	Pz3-2	1,24	Pz3-5	0,77	Pz3-50	0,70	Pz3-100	0,64

SLOT



€ per Bit		2 U		5 U		50 U		100 U	
	L ₁ mm		€		€		€		€
0,5X3,0	25	P0,5X3,0-2	1,68	P0,5X3,0-5	1,45	P0,5X3,0-50	1,32	P0,5X3,0-100	1,24
0,6X3,5	25	P0,6X3,5-2	1,68	P0,6X3,5-5	1,45	P0,6X3,5-50	1,32	P0,6X3,5-100	1,24
0,5X4,0	25	P0,5X4,0-2	1,68	P0,5X4,0-5	1,45	P0,5X4,0-50	1,32	P0,5X4,0-100	1,24
0,6X4,5	25	P0,6X4,5-2	1,68	P0,6X4,5-5	1,45	P0,6X4,5-50	1,32	P0,6X4,5-100	1,24
0,8X4,0	25	P0,8X4,0-2	1,68	P0,8X4,0-5	1,45	P0,8X4,0-50	1,32	P0,8X4,0-100	1,24
0,8X5,0	25	P0,8X5,0-2	1,68	P0,8X5,0-5	1,45	P0,8X5,0-50	1,32	P0,8X5,0-100	1,24
0,8X5,5	25	P0,8X5,5-2	1,68	P0,8X5,5-5	1,45	P0,8X5,5-50	1,32	P0,8X5,5-100	1,24
1,0X5,5	25	P1X5,5-2	1,68	P1X5,5-5	1,45	P1X5,5-50	1,32	P1X5,5-100	1,24
1,0X6,0	25	P1X6,0-2	1,68	P1X6,0-5	1,45	P1X6,0-50	1,32	P1X6,0-100	1,24
1,2X6,5	25	P1,2X6,5-2	1,68	P1,2X6,5-5	1,45	P1,2X6,5-50	1,32	P1,2X6,5-100	1,24
1,2X8,0	25	P1,2X8,0-2	1,68	P1,2X8,0-5	1,45	P1,2X8,0-50	1,32	P1,2X8,0-100	1,24

INTERCHANGEABLE SCREWDRIVER BITS



25mm
OVERALL
LENGTH
(L₁)



TORX



€ per Bit	2 U		5 U		50 U		100 U		
	L ₁ mm	€	€	€	€	€	€		
T5	25	PT5-2	2,21	PT5-5	1,92	PT5-50	1,73	PT5-100	1,64
T6	25	PT6-2	2,21	PT6-5	1,92	PT6-50	1,73	PT6-100	1,64
T7	25	PT7-2	2,21	PT7-5	1,92	PT7-50	1,73	PT7-100	1,64
T8	25	PT8-2	2,21	PT8-5	1,92	PT8-50	1,73	PT8-100	1,64
T9	25	PT9-2	2,21	PT9-5	1,92	PT9-50	1,73	PT9-100	1,64
T10	25	PT10-2	1,81	PT10-5	1,42	PT10-50	1,27	PT10-100	1,20
T15	25	PT15-2	1,81	PT15-5	1,42	PT15-50	1,27	PT15-100	1,20
T20	25	PT20-2	1,81	PT20-5	1,42	PT20-50	1,27	PT20-100	1,20
T25	25	PT25-2	1,81	PT25-5	1,42	PT25-50	1,27	PT25-100	1,20
T27	25	PT27-2	1,81	PT27-5	1,42	PT27-50	1,27	PT27-100	1,20
T30	25	PT30-2	1,81	PT30-5	1,42	PT30-50	1,27	PT30-100	1,20
T40	25	PT40-2	1,81	PT40-5	1,42	PT40-50	1,27	PT40-100	1,20

TORX
ROUND



€ per Bit	2 U		5 U		50 U		100 U		
	L ₁ mm	€	€	€	€	€	€		
TR10	25	PTR10-2	5,88	PTR10-5	5,11	PTR10-50	4,61	PTR10-100	4,33
TR15	25	PTR15-2	5,88	PTR15-5	5,11	PTR15-50	4,61	PTR15-100	4,33
TR20	25	PTR20-2	5,88	PTR20-5	5,11	PTR20-50	4,61	PTR20-100	4,33
TR25	25	PTR25-2	5,88	PTR25-5	5,11	PTR25-50	4,61	PTR25-100	4,33
TR30	25	PTR30-2	5,88	PTR30-5	5,11	PTR30-50	4,61	PTR30-100	4,33
TR40	25	PTR40-2	5,88	PTR40-5	5,11	PTR40-50	4,61	PTR40-100	4,33

ROBERTSON



€ per Bit	2 U		5 U		50 U		100 U		
	L ₁ mm	€	€	€	€	€	€		
N°1	25	PC1-2	2,37	PC1-5	2,06	PC1-50	1,86	PC1-100	1,75
N°2	25	PC2-2	2,37	PC2-5	2,06	PC2-50	1,86	PC2-100	1,75
N°3	25	PC3-2	2,37	PC3-5	2,06	PC3-50	1,86	PC3-100	1,75

INTERCHANGEABLE SCREWDRIVER BITS

Screwdriver bits

Pink

25mm
 OVERALL
 LENGTH
 (L₁)

TORX
SECURITY

€ per Bit		2 U		5 U		50 U		100 U	
	L ₁ mm		€		€		€		€
TS10	25	PTS10-2	3,15	PTS10-5	2,73	PTS10-50	2,46	PTS10-100	2,33
TS15	25	PTS15-2	3,15	PTS15-5	2,73	PTS15-50	2,46	PTS15-100	2,33
TS20	25	PTS20-2	3,15	PTS20-5	2,73	PTS20-50	2,46	PTS20-100	2,33
TS25	25	PTS25-2	3,15	PTS25-5	2,73	PTS25-50	2,46	PTS25-100	2,33
TS27	25	PTS27-2	3,15	PTS27-5	2,73	PTS27-50	2,46	PTS27-100	2,33
TS30	25	PTS30-2	3,15	PTS30-5	2,73	PTS30-50	2,46	PTS30-100	2,33
TS40	25	PTS40-2	3,15	PTS40-5	2,73	PTS40-50	2,46	PTS40-100	2,33

HEXAGONAL

€ per Bit		2 U		5 U		50 U		100 U	
	L ₁ mm		€		€		€		€
2 mm	25	PHX2-2	1,74	PHX2-5	1,58	PHX2-50	1,41	PHX2-100	1,35
2,5 mm	25	PHX2,5-2	1,74	PHX2,5-5	1,58	PHX2,5-50	1,41	PHX2,5-100	1,35
3 mm	25	PHX3-2	1,74	PHX3-5	1,58	PHX3-50	1,41	PHX3-100	1,35
4 mm	25	PHX4-2	1,74	PHX4-5	1,58	PHX4-50	1,41	PHX4-100	1,35
5 mm	25	PHX5-2	1,74	PHX5-5	1,58	PHX5-50	1,41	PHX5-100	1,35
6 mm	25	PHX6-2	1,74	PHX6-5	1,58	PHX6-50	1,41	PHX6-100	1,35
8 mm	25	PHX8-2	2,07	PHX8-5	1,88	PHX8-50	1,81	PHX8-100	1,71

TRI
WING

€ per Bit		2 U		5 U		50 U		100 U	
	L ₁ mm		€		€		€		€
N°4	25	PTRW4-2	10,40	PTRW4-5	9,05	PTRW4-50	8,14	PTRW4-100	7,69
N°5	25	PTRW5-2	10,40	PTRW5-5	9,05	PTRW5-50	8,14	PTRW5-100	7,69
N°6	25	PTRW6-2	10,40	PTRW6-5	9,05	PTRW6-50	8,14	PTRW6-100	7,69
N°8	25	PTRW8-2	10,40	PTRW8-5	9,05	PTRW8-50	8,14	PTRW8-100	7,69

XZN

€ per Bit		2 Pcs		5 Pcs		50 Pcs		100 Pcs	
	L ₁ mm		€		€		€		€
N°4	25	PXZN4-2	6,38	PXZN4-5	5,55	PXZN4-50	4,99	PXZN4-100	4,72
N°5	25	PXZN5-2	6,38	PXZN5-5	5,55	PXZN5-50	4,99	PXZN5-100	4,72
N°6	25	PXZN6-2	6,38	PXZN6-5	5,55	PXZN6-50	4,99	PXZN6-100	4,72
N°8	25	PXZN8-2	7,15	PXZN8-5	6,22	PXZN8-50	6,11	PXZN8-100	5,99
N°10	25	PXZN10-2	7,15	PXZN10-5	6,22	PXZN10-50	6,11	PXZN10-100	5,99

INTERCHANGEABLE SCREWDRIVER BITS



50mm
OVERALL
LENGTH
(L₁)



PHILLIPS



€ per Bit		2 U		5 U		50 U	
	L ₁ mm		€		€		€
Ph 1	50	Ph1X50-2	2,83	Ph1X50-5	2,47	Ph1X50-50	2,22
Ph 2	50	Ph2X50-2	2,83	Ph2X50-5	2,47	Ph2X50-50	2,22
Ph 3	50	Ph3X50-2	2,83	Ph3X50-5	2,47	Ph3X50-50	2,22
Ph 4	50	Ph4X50-2	-	Ph4X50-5	-	Ph4X50-50	-

POZIDRIV



€ per Bit		2 U		5 U		50 U	
	L ₁ mm		€		€		€
Pz 1	50	Pz1X50-2	2,83	Pz1X50-5	2,47	Pz1X50-50	2,22
Pz 2	50	Pz2X50-2	2,83	Pz2X50-5	2,47	Pz2X50-50	2,22
Pz 3	50	Pz3X50-2	2,83	Pz3X50-5	2,47	Pz3X50-50	2,22
Pz 4	50	Pz4X50-2	-	Pz4X50-5	-	Pz4X50-50	-

SLOT



€ per Bit		2 U		5 U		50 U	
	L ₁ mm		€		€		€
0,5X4,0	50	P0,5X4,0X50-2	4,47	P0,5X4,0X50-5	3,87	P0,5X4,0X50-50	3,47
0,5X3,0	50	P0,5X3,0X50-2	4,47	P0,5X3,0X50-5	3,87	P0,5X3,0X50-50	3,47
0,6X3,5	50	P0,6X3,5X50-2	4,47	P0,6X3,5X50-5	3,87	P0,6X3,5X50-50	3,47
0,6X4,5	50	P0,6X4,5X50-2	4,47	P0,6X4,5X50-5	3,87	P0,6X4,5X50-50	3,47
0,8X4,0	50	P0,8X4,0X50-2	4,47	P0,8X4,0X50-5	3,87	P0,8X4,0X50-50	3,47
0,8X5,0	50	P0,8X5,0X50-2	4,47	P0,8X5,0X50-5	3,87	P0,8X5,0X50-50	3,47
0,8X5,5	50	P0,8X5,5X50-2	4,47	P0,8X5,5X50-5	3,87	P0,8X5,5X50-50	3,47
1X5,5	50	P1X5,5X50-2	4,47	P1X5,5X50-5	3,87	P1X5,5X50-50	3,47
1X6,0	50	P1X6,0X50-2	4,47	P1X6,0X50-5	3,87	P1X6,0X50-50	3,47
1,2X6,5	50	P1,2X6,5X50-2	4,47	P1,2X6,5X50-5	3,87	P1,2X6,5X50-50	3,47
1,2X8,0	50	P1,2X8,0X50-2	4,47	P1,2X8,0X50-5	3,87	P1,2X8,0X50-50	3,47

INTERCHANGEABLE SCREWDRIVER BITS

Screwdriver bits

Pink

50mm
 OVERALL
 LENGTH
 (L₁)

TORX



€ per Bit

2 U

5 U

50 U

	L ₁ mm		€		€		€
T 5	50	PT5X50-2	5,71	PT5X50-5	4,36	PT5X50-50	4,03
T 6	50	PT6X50-2	5,71	PT6X50-5	4,36	PT6X50-50	4,03
T 7	50	PT7X50-2	5,71	PT7X50-5	4,36	PT7X50-50	4,03
T 8	50	PT8X50-2	5,71	PT8X50-5	4,36	PT8X50-50	4,03
T 9	50	PT9X50-2	5,71	PT9X50-5	4,36	PT9X50-50	4,03
T 10	50	PT10X50-2	5,26	PT10X50-5	4,09	PT10X50-50	3,69
T 15	50	PT15X50-2	5,26	PT15X50-5	4,09	PT15X50-50	3,69
T 20	50	PT20X50-2	5,26	PT20X50-5	4,09	PT20X50-50	3,69
T 25	50	PT25X50-2	5,26	PT25X50-5	4,09	PT25X50-50	3,69
T 27	50	PT27X50-2	5,26	PT27X50-5	4,09	PT27X50-50	3,69
T 30	50	PT30X50-2	5,26	PT30X50-5	4,09	PT30X50-50	3,69
T 40	50	PT40X50-2	5,26	PT40X50-5	4,09	PT40X50-50	3,69

ROBERTSON



€ per Bit

2 U

5 U

50 U

	L ₁ mm		€		€		€
Nº1	50	PC1X50-2	6,86	PC1X50-5	5,97	PC1X50-50	5,37
Nº2	50	PC2X50-2	6,86	PC2X50-5	5,97	PC2X50-50	5,37
Nº3	50	PC3X50-2	6,86	PC3X50-5	5,97	PC3X50-50	5,37

HEXAGONAL



€ per Bit

2 U

5 U

50 U

	L ₁ mm		€		€		€
2mm	50	PHX2X50-2	5,56	PHX2X50-5	4,83	PHX2X50-50	4,34
2,5mm	50	PHX2,5X50-2	5,56	PHX2,5X50-5	4,83	PHX2,5X50-50	4,34
3mm	50	PHX3X50-2	5,56	PHX3X50-5	4,83	PHX3X50-50	4,34
4mm	50	PHX4X50-2	5,56	PHX4X50-5	4,83	PHX4X50-50	4,34
5mm	50	PHX5X50-2	5,56	PHX5X50-5	4,83	PHX5X50-50	4,34
6mm	50	PHX6X50-2	5,56	PHX6X50-5	4,83	PHX6X50-50	4,34
8mm	50	PHX8X50-2	7,11	PHX8X50-5	6,51	PHX8X50-50	5,57

INTERCHANGEABLE SCREWDRIVER BITS



70mm
OVERALL
LENGTH
(L₁)



PHILLIPS



€ per Bit		2 U		5 U	
	L ₁ mm		€		€
Ph 1	70	Ph1X70-2	6,64	Ph1X70-5	5,78
Ph 2	70	Ph2X70-2	6,64	Ph2X70-5	5,78
Ph 3	70	Ph3X70-2	6,64	Ph3X70-5	5,78
Ph 4	70	Ph4X70-2	-	Ph4X70-5	-

POZIDRIV



€ per Bit		2 U		5 U	
	L ₁ mm		€		€
Pz 1	70	Pz1X70-2	6,70	Pz1X70-5	5,83
Pz 2	70	Pz2X70-2	6,70	Pz2X70-5	5,83
Pz 3	70	Pz3X70-2	6,70	Pz3X70-5	5,83
Pz 4	70	Pz4X70-2	-	Pz4X70-5	-



90mm
OVERALL
LENGTH
(L₁)



PHILLIPS



€ per Bit		2 U		5 U	
	L ₁ mm		€		€
Ph 1	90	Ph1X90-2	8,18	Ph1X90-5	7,12
Ph 2	90	Ph2X90-2	8,18	Ph2X90-5	7,12
Ph 3	90	Ph3X90-2	8,18	Ph3X90-5	7,12
Ph 4	90	Ph4X90-2	-	Ph4X90-5	-

POZIDRIV



€ per Bit		2 U		5 U	
	L ₁ mm		€		€
Pz 1	90	Pz1X90-2	8,26	Pz1X90-5	7,19
Pz 2	90	Pz2X90-2	8,26	Pz2X90-5	7,19
Pz 3	90	Pz3X90-2	8,26	Pz3X90-5	7,19
Pz 4	90	Pz4X90-2	-	Pz4X90-5	-

INTERCHANGEABLE SCREWDRIVER BITS
TiN

25mm
 OVERALL
 LENGTH
 (L₁)

Screwdriver bits

Pink

PHILLIPS

€ per Bit

2 U

5 U

50 U

	L ₁ mm		€		€		€
Ph 1	25	Ph1T-2	3,34	Ph1T-5	2,52	Ph1T-50	2,27
Ph 2	25	Ph2T-2	3,34	Ph2T-5	2,52	Ph2T-50	2,27
Ph 3	25	Ph3T-2	3,34	Ph3T-5	2,52	Ph3T-50	2,27

POZIDRIV

€ per Bit

2 U

5 U

50 U

	L ₁ mm		€		€		€
Pz 1	25	Pz1T-2	3,38	Pz1T-5	2,54	Pz1T-50	2,29
Pz 2	25	Pz2T-2	3,38	Pz2T-5	2,54	Pz2T-50	2,29
Pz 3	25	Pz3T-2	3,38	Pz3T-5	2,54	Pz3T-50	2,29

SLOT

€ per Bit

2 U

5 U

50 U

	L ₁ mm		€		€		€
0,6X4,5	25	PO,6X4,5T-2	3,61	PO,6X4,5T-5	3,13	PO,6X4,5T-50	2,82
0,8X5,5	25	PO,8X5,5T-2	3,61	PO,8X5,5T-5	3,13	PO,8X5,5T-50	2,82
1X5,5	25	P1X5,5T-2	3,61	P1X5,5T-5	3,13	P1X5,5T-50	2,82
1,2X6,5	25	P1,2X6,5T-2	3,61	P1,2X6,5T-5	3,13	P1,2X6,5T-50	2,82

TORX

€ per Bit

2 U

5 U

50 U

	L ₁ mm		€		€		€
T 10	25	PT10T-2	3,48	PT10T-5	3,13	PT10T-50	2,73
T 15	25	PT15T-2	3,48	PT15T-5	3,13	PT15T-50	2,73
T 20	25	PT20T-2	3,48	PT20T-5	3,13	PT20T-50	2,73
T 25	25	PT25T-2	3,48	PT25T-5	3,13	PT25T-50	2,73
T 27	25	PT27T-2	3,48	PT27T-5	3,13	PT27T-50	2,73
T 30	25	PT30T-2	3,48	PT30T-5	3,13	PT30T-50	2,73
T 40	25	PT40T-2	3,48	PT40T-5	3,13	PT40T-50	2,73

INTERCHANGEABLE SCREWDRIVER BITS

TiN



50mm
OVERALL
LENGTH
(L₁)



PHILLIPS



€ per Bit		2 U		5 U		50 U	
	L ₁ mm		€		€		€
Ph 1	50	Ph1Tx50-2	7,71	Ph1Tx50-5	6,70	Ph1Tx50-50	6,01
Ph 2	50	Ph2Tx50-2	7,71	Ph2Tx50-5	6,70	Ph2Tx50-50	6,01
Ph 3	50	Ph3Tx50-2	7,71	Ph3Tx50-5	6,70	Ph3Tx50-50	6,01

POZIDRIV



€ per Bit		2 U		5 U		50 U	
	L ₁ mm		€		€		€
Pz 1	50	Pz1Tx50-2	7,78	Pz1Tx50-5	6,76	Pz1Tx50-50	6,07
Pz 2	50	Pz2Tx50-2	7,78	Pz2Tx50-5	6,76	Pz2Tx50-50	6,07
Pz 3	50	Pz3Tx50-2	7,78	Pz3Tx50-5	6,76	Pz3Tx50-50	6,07

TORX



€ per Bit		2 U		5 U		50 U	
	L ₁ mm		€		€		€
T 10	50	PT10Tx50-2	11,02	PT10Tx50-5	9,58	PT10Tx50-50	8,61
T 15	50	PT15Tx50-2	11,02	PT15Tx50-5	9,58	PT15Tx50-50	8,61
T 20	50	PT20Tx50-2	11,02	PT20Tx50-5	9,58	PT20Tx50-50	8,61
T 25	50	PT25Tx50-2	11,02	PT25Tx50-5	9,58	PT25Tx50-50	8,61
T 27	50	PT27Tx50-2	11,02	PT27Tx50-5	9,58	PT27Tx50-50	8,61
T 30	50	PT30Tx50-2	11,02	PT30Tx50-5	9,58	PT30Tx50-50	8,61
T 40	50	PT40Tx50-2	11,02	PT40Tx50-5	9,58	PT40Tx50-50	8,61

SCREWDRIVER BIT HOLDERS

MAGNETIC SCREWDRIVER BIT HOLDERS

	L ₁ mm	SHANK TYPE	€
PMGx51	51	MAGNETIC WITHOUT RING	6,66
PMGx58	58	MAGNETIC WITHOUT RING	6,91
PMGx74	74	MAGNETIC WITH RING	11,40
PMGx100	100	MAGNETIC WITH RING	13,79
PMGx150	150	MAGNETIC WITH RING	15,36
PMGx200	200	MAGNETIC WITH RING	18,18
PMGx250	250	MAGNETIC WITH RING	27,96
PMGSDSx78	78	SDS PLUS	19,08
PBERx74	74	BERYLLIUM	48,95*
PDESSx70	70	5/16" DESSOUTTER	30,16*
P7x74	74	7mm Fein	32,76*

*Until end of stock



Ref. PMGSDSx78

Ref. PMGX74

Ref. PMGX100

MAGNETIC HOLDER WITH QUICK CHANGE (VALID FOR 1/4" SCREWDRIVER BITS WITH CIRCLIP)

	L ₁ mm	SHANK TYPE	€
PCR60	60	Quick change 1/4" Valid for 1/4" screwdriver bits with circlip	16,96
PCR74	74	Quick change 1/4" Valid for 1/4" screwdriver bits with circlip	17,47
PCRSDSX80	80	SDS PLUS	27,82



Ref. PCRSDSX80

Ref. PCR60

SCREWDRIVER BITS HOLDERS WITH ADJUSTABLE STOPPER

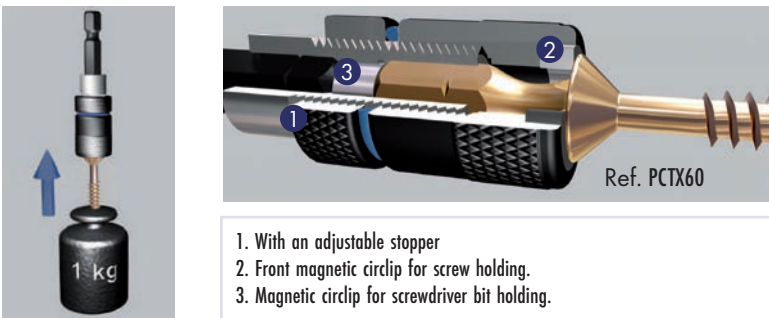

	L ₁ mm	SHANK TYPE	€
PCT60	60	Adjustable stopper	15,97



Ref. PCT60

STANDARD HEXAGONAL NUT DRIVERS



MAGNETIC HEXAGONAL NUT DRIVERS



	mm	"		€/ 1U.
PLIHX5-2	5,0		2	6,05
PLIHX5,5-2	5,5		2	6,05
PLIHX6-2	6,0		2	6,05
PLIHX1/4-2		1/4"=6,35	2	6,05
PLIHX7-2	7,0		2	6,18
PLIHX5/16-2		5/16"=7,93	2	6,18
PLIHX8-2	8,0		2	6,18
PLIHX3/8-2		3/8"=9,52	2	6,18
PLIHX10-2	10,0		2	6,33
PLIHX11-2	11,0		2	6,51
PLIHX12-2	12,0		2	6,57
PLIHX13-2	13,0		2	6,89

7 MAGNETIC HEXAGONAL NUT DRIVERS BOX

REFERENCE	EPLL
QUANTITY	7
CONTENT	HX1/4 - HX7 - HX8 - HX3/8 HX10 - HX12 - HX13
PRICE €	44,85



RATCHET SCREWDRIVER WITH BITS STORAGE



1. High quality and performance
2. Left and right hand turn
3. Telescopic and adjustable
4. Manufactured in high quality plastic and steel

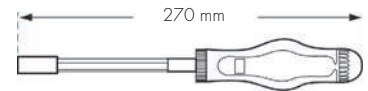
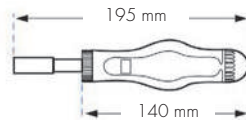

DTRC

- Screwdriver bits included:
- PH1 - PH2
 - PZ1 - PZ2
 - T15 - T20 - T25 - T30

34,07 €

SCREWDRIVER BITS SETS

DiN 7 SCREWDRIVER BIT SETS



Ref. EPT1

REFERENCE	EPT1	EPT2	EPT3
QUANTITY	7	7	7
CONTENT	<ul style="list-style-type: none"> PH1 - PH2 PZ1 - PZ2 0,8x5,5 - 1,2x6,5 1 PMG Bit holder	<ul style="list-style-type: none"> T10 - T15 T20 - T25 T30 - T40 1 PMG Bit holder	<ul style="list-style-type: none"> PH1 - PH2 - PH3 PZ1 - PZ2 - PZ3 1 PMG Bit holder
PRICE €	11,86	15,98	14,21



Ref. EPTT1

REFERENCE	EPTT1	EPTT2	EPTT3
QUANTITY	7	7	7
CONTENT	<ul style="list-style-type: none"> PH1 - PH2 PZ1 - PZ2 0,8x5,5 - 1,2x6,5 1 PMG Bit holder	<ul style="list-style-type: none"> T10 - T15 T20 - T25 T30 - T40 1 PMG Bit holder	<ul style="list-style-type: none"> PH1 - PH2 - PH3 PZ1 - PZ2 - PZ3 1 PMG Bit holder
PRICE €	33,63	39,00	32,42

SCREWDRIVER BITS SETS
PLUS & TiN 12 SCREWDRIVER BIT SETS

 Ref. EPT4	REFERENCE	EPT4	EPT5
	QUANTITY	12	12
	CONTENT	<ul style="list-style-type: none"> ⊕ PH1 - PH2(2) - PH3 ⊕ PZ1 - PZ2(2) - PZ3 ⊖ 0,6x4,5 - 0,8x5,5 - 1,2x6,5 1 PMG Bit holder	<ul style="list-style-type: none"> ★ T10 - T15(2) ★ T20(2) - T25(2) T27 - T30(2) - T40 1 PMG Bit holder
	PRICE €	15,90	21,84

 Ref. EPT4	REFERENCE	EPT4	EPT5
	QUANTITY	12	12
	CONTENT	<ul style="list-style-type: none"> ⊕ PH1 - PH2(2) - PH3 ⊕ PZ1 - PZ2(2) - PZ3 ⊖ 0,6x4,5 - 0,8x5,5 - 1,2x6,5 1 PCT Bit holder	<ul style="list-style-type: none"> ★ T10 - T15(2) ★ T20(2) - T25(2) T27 - T30(2) - T40 1 PCT Bit holder
	PRICE €	42,35	49,82

PLUS & TiN 31 SCREWDRIVER BIT SETS

 Ref. EPT6	REFERENCE	EPT6
	QUANTITY	31
	CONTENT	<ul style="list-style-type: none"> ⊕ PH1(3) - PH2(3) - PH3(3) ⊕ PZ1(3) - PZ2(3) - PZ3(3) ⊖ 0,6x4,5 - 0,8x5,5 - 1,2x6,5 <ul style="list-style-type: none"> ★ T10 - T15 - T20 - T25 - T30 - T40 ○ H3 - H4 - H5 1 PMG Bit holder
	PRICE €	45,45

REFERENCE	EPT6
QUANTITY	31
CONTENT	<ul style="list-style-type: none"> ⊕ PH1(3) - PH2(3) - PH3(3) ⊕ PZ1(3) - PZ2(3) - PZ3(3) ⊖ 0,6x4,5 - 0,8x5,5 - 1,2x6,5 <ul style="list-style-type: none"> ★ T10 - T15 - T20 - T25 - T30 - T40 ○ H3 - H4 - H5 1 PCT Bit holder
PRICE €	96,43

PLUS & TiN 36 SCREWDRIVER BIT SETS

 Ref. EPT7	REFERENCE	EPT7
	QUANTITY	36
	CONTENT	<ul style="list-style-type: none"> ⊕ PH1(3) - PH2(3) - PH3(3) ⊕ PZ1(3) - PZ2(3) - PZ3(3) ⊖ 0,5 x 4 - 0,6 x 4,5 - 0,8 x 5 - 0,8 x 5,5 - 1 x 6 - 1,2 x 6,5 - 1,2 x 8 <ul style="list-style-type: none"> ★ T10 - T15 - T20 - T25 - T27 - T30 - T40 ○ H2 - H2,5 - H3 - H4 - H5 - H6 - H8 1 PMG Bit holder
	PRICE €	57,55

REFERENCE	EPT7*
QUANTITY	36
CONTENT	<ul style="list-style-type: none"> ⊕ PH1(3) - PH2(3) - PH3(3) ⊕ PZ1(3) - PZ2(3) - PZ3(3) ⊖ 0,5 x 4 - 0,6 x 4,5 - 0,8 x 5 - 0,8 x 5,5 - 1 x 6 - 1,2 x 6,5 - 1,2 x 8 <ul style="list-style-type: none"> ★ T10 - T15 - T20 - T25 - T27 - T30 - T40 ○ H2 - H2,5 - H3 - H4 - H5 - H6 - H8 1 PCT Bit holder
PRICE €	118,09*

*Until end of stock

SCREWDRIVER BITS SETS











45 & 80 SCREWDRIVER BITS SETS



















Ref. EPT45

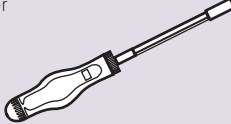

Ref. EPT80

REFERENCE QUANTITY CONTENT	EPT45	
	45	
	 PH1 (2) - PH2(2) - PH3(2)	 Hexagonal sockets (mm): 5 - 6 - 7 - 8 - 9 - 10 - 11 - 12 - 13 - 14
	 PZ1 (2) - PZ2(2) - PZ3(2)	 1 Sockets adapter
	 0,5x3-0,6x4,5-0,8x5,5(2)-1,2x6,5-1,6x8	 1 Screwdriver bits adapter
	 H2,5 - H3 - H4 - H5 - H6 - H7	 1 PCR Magnetic bit holder
	 T10 - T15 - T20 - T25 - T30 - T40	 1 Ratched handle 72 teeth 1 Screwdriver
PRICE €	144,01	

REFERENCE QUANTITY CONTENT	EPT80*	
	80	
	 PH0 - PH1 - PH2(4) - PH3(2)	 C0 - C1 - C2 - C3
	 PZ1 - PZ2(4) - PZ3(2)	 SP4 - SP6 - SP8 - SP10
	 0,5x3-0,6x4,5-0,8x5,5(2)-1,2x6,5-1,6x8	 HS3 - HS4 - HS5 - HS6
	 H2 - H2,5 - H3 - H4 - H5 - H6 - H7 - H8	 1 PCR Magnetic bit holder
	 TW1 - TW2 - TW3 - TW4 - TW5	 1 Screwdriver
	 TQ5 - TQ6 - TQ8 - TQ10	
	 T5 - T6 - T7 - T8 - T9 - T10 - T15 T20(2) - T25(2) - T27 - T30 - T40	 PH1 - PH2
	 TS10 - TS15 - TS20 - TS25 - TS30 - TS40	 PZ1 - PZ2
		 T15 - T20 - T25 - T30
	PRICE €	147,85 *

*Until end of stock

5 & 10 SETS DISPLAYS



Ref. EPEPT7



Ref. EPEPT80

EPEPT7	
36 pieces 10 Sets	
	
Ref. EPT7	
575,52* €	

*Until end of stock

EPEPT80	
80 pieces 5 Sets	
	
Ref. EPT80	
858,27* €	

*Until end of stock

MACHINE SCREW EXTRACTORS

MICRO GRABIT



		EP
		€
EP451C	M3	52,48
EP452C	M4	52,48
EP453C	M5	52,48
EP454C	M6	52,48

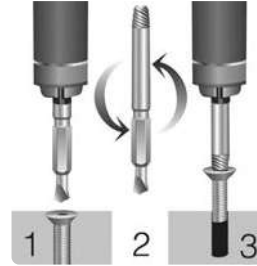

1. Drill the screw
2. Flip the extractor
3. Remove



PRO GRABIT WITH 1/4" HEXAGONAL BODY



		EP
		€
EP8401C	M5	41,62
EP8402C	M6	49,17
EP8403C	M8	49,17
EP8404C	M10	51,60

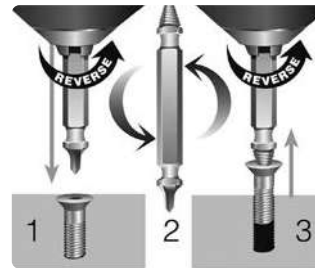
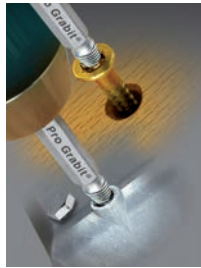

1. Drill the screw
2. Flip the extractor
3. Remove



DRILL-OUT WITH PILOT DRILL (M6-M12)



		EP
		€
EP205C	M6	50,88
EP312C	M8	61,65
EP375C	M10	61,65
EP500C	M12	69,39

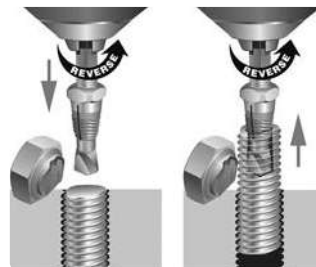

X-OUT WITH HEXAGONAL SHANK



		EP
		€
EP3701C	M3	41,62
EP3702C	M4	41,62
EP3703C	M5	46,26

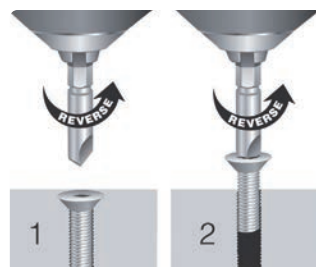

MACHINE SCREW EXTRACTORS SETS

MICRO GRABIT



REFERENCE	EP450C
QUANTITY	4
CONTENT	M3-M4-M5-M6
PRICE €	215,24

PROGRABIT



REFERENCE	EP8420C
QUANTITY	2
CONTENT	M5-M6
PRICE €	87,99*



REFERENCE	EP8430C
QUANTITY	3
CONTENT	M5-M6-M8
PRICE €	128,33*



REFERENCE	EP8440C
QUANTITY	4
CONTENT	M5-M6-M8-M10
PRICE €	176,12

*Until end of stock

MICRO GRABIT



REFERENCE	EP401C
QUANTITY	4
CONTENT	M6-M8-M10-M12
PRICE €	253,21

MIX



REFERENCE	EP701C
QUANTITY	7
CONTENT	MICRO GRABIT (M3-M6) DRILL OUT (M8-M12)
PRICE €	354,49*



REFERENCE	EP100C
QUANTITY	10
CONTENT	X OUT (M3-M5)-MICRO GRABIT (M3-M6) DRILL OUT (M8-M12)
PRICE €	396,07*

*Until end of stock

HAND SCREW EXTRACTORS SETS

HAND SCREW EXTRACTOR CLASSIC SETS

Use a BLUE-MASTER drill to make a hole where the screw extractor should be introduced.
Turn the extractor anti-clockwise until the broken screw comes out.

REFERENCE	EX/1-5	EX/1-6	EX/1-8
QUANTITY	5	6	8
CONTENT	M3 - M18	M3 - M24	M3 - M45
PRICE €	22,27	30,13	69,55

Ref. EX/1-6



ROLLED- HAND EXTRACTORS



	for SCREWS	mm	mm	L1 mm	Ø _{min} mm	Ø _{max} mm	EX €
EX/1	M3 - M6	3,2	2,5	51	1,75	3,95	2,76
EX/2	M6 - M8	4,0	3,0	60	2,20	4,80	2,76
EX/3	M8 - M11	5,1	4,5	68	3,30	6,40	3,28
EX/4	M11 - M14	6,2	6,0	76	4,75	8,40	4,06
EX/5	M14 - M18	8,6	8,0	86	6,35	11,00	5,28
EX/6	M18 - M24	12,0	11,0	95	9,50	15,00	8,93
EX/7	M24 - M33	15,9	14,0	105	12,70	19,00	24,19
EX/8	M33 - M45	20,0	21,0	111	19,00	25,00	39,63

REFERENCE	EXTT
QUANTITY	10
CONTENT	EX/1-EX/2-EX/3-EX/4-EX/5 Ref. BC3 Ø2,5-3-4,5-6-8
PRICE €	37,15



HAND SCREW EXTRACTORS SETS

MILLED - HAND EXTRACTORS



	for SCREWS	mm		L ₁ mm	∅ _{min} mm	∅ _{max.} mm	EFX €
EFX/1	M3-M6	2,9	2	50	1,9	3,2	3,51
EFX/2	M6-M8	3,9	3,2	60	2,8	5	3,51
EFX/3	M8-M11	4,8	4	68	3,2	6,5	4,14
EFX/4	M11-M14	6,7	6,4	75	5,2	9	5,14
EFX/5	M14-M18	8,5	7,1	85	6,4	11	6,67
EFX/6	M18-M25	11,8	9,5	95	9,4	15	11,31
EFX/7	M25-M35	14,3	12,7	106	12,8	19	30,63
EFX/8	M35-M45	19,5	19,5	110	19,3	25	50,16

Ref. EFX/1-5



REFERENCE	EFX/1-5
QUANTITY	5
CONTENT	M3 - M18
PRICE €	26,82

1/4" HEXAGONAL SHANK TOOLS

DIN 338 TWIST DRILL

Ref. BH2

HSS

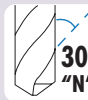
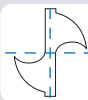

OX



	∅ mm	L ₁ x L ₂ mm		BH2 €
BH20300	3,00	61 x 33	1/4"	7,32
BH20400	4,00	75 x 43	1/4"	7,75
BH20500	5,00	86 x 52	1/4"	9,64
BH20600	6,00	93 x 57	1/4"	10,41
BH20700	7,00	109 x 69	1/4"	13,12
BH20800	8,00	117 x 75	1/4"	14,73
BH20900	9,00	125 x 81	1/4"	16,57
BH21000	10,00	133 x 87	1/4"	18,46





REFERENCE	BH29335	BH29333
QUANTITY	5	8
QUALITY	HSS	HSS
CONTENT	∅ 3 - 4 - 5 - 6 - 8 mm	∅ 3 - 4 - 5 - 6 - 7 - 8 - 9 - 10 mm
PRICE €	50,62	67,71

EXTRA SHORT METAL DRILL

Ref. BC59

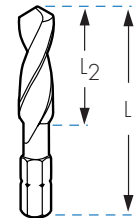
HSS-G



	∅ mm	L ₁ x L ₂ mm		BC59 €	BC59CR €
BC590100	1,00	34 x 12	1/4"	7,16	-
BC590150	1,50	34 x 12	1/4"	7,16	-
BC590200	2,00	34 x 12	1/4"	7,16	7,16
BC590250	2,50	36 x 14	1/4"	7,16	7,16
BC590300	3,00	38 x 16	1/4"	7,16	7,16
BC590330	3,30	40 x 18	1/4"	7,16	7,16
BC590350	3,50	40 x 18	1/4"	7,16	7,16
BC590400	4,00	44 x 20	1/4"	7,16	7,16
BC590420	4,20	45 x 20	1/4"	7,16	7,16
BC590450	4,50	46 x 24	1/4"	7,16	7,16
BC590500	5,00	50 x 26	1/4"	7,16	7,16
BC590550	5,50	50 x 26	1/4"	7,82	7,82
BC590600	6,00	50 x 26	1/4"	7,82	7,82
BC590650	6,50	50 x 30	1/4"	7,82	7,82
BC590680	6,80	50 x 30	1/4"	7,82	7,82
BC590700	7,00	50 x 30	1/4"	7,82	7,82
BC590750	7,50	51 x 32	1/4"	8,85	8,85
BC590800	8,00	51 x 32	1/4"	8,85	8,85
BC590850	8,50	53 x 33	1/4"	8,85	8,85
BC590900	9,00	53 x 33	1/4"	10,68	10,68
BC590950	9,50	54 x 38	1/4"	10,68	10,68
BC591000	10,00	54 x 38	1/4"	10,68	10,68
BC591020	10,20	54 x 38	1/4"	10,68	10,68

1/4" HEXAGONAL SHANK TOOLS

DRILL TAP COUNTERSINK

HSS-G

Ref. MAHM

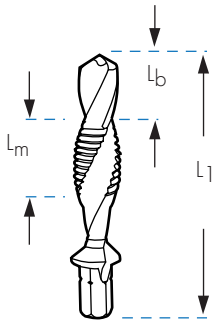



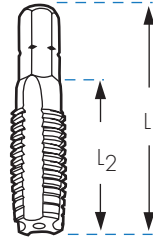

HSS-G TAP

HSS-G

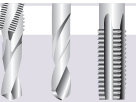
Ref. M



			MAHM	MAHMCR
	$L_1 \times L_b \times L_m$ mm		€	€
M 3 x 0,50	36 x 5 x 6	1/4"	23,36	23,36
M 4 x 0,70	39 x 6 x 7	1/4"	23,36	23,36
M 5 x 0,80	41 x 8 x 8	1/4"	24,38	24,38
M 6 x 1,00	44 x 8 x 10	1/4"	25,39	25,39
M 8 x 1,25	50 x 10 x 11	1/4"	35,10	35,10
M 10 x 1,50	59 x 11 x 11	1/4"	42,35	42,35

		$L_1 \times L_2$ mm		M €	MCR €
					
M 3 x 0,50		33 x 11	1/4"	8,48	8,48
M 4 x 0,70		35 x 12	1/4"	8,48	8,48
M 5 x 0,80		36 x 15	1/4"	10,80	10,80
M 6 x 1,00		39 x 18	1/4"	10,80	10,80
M 8 x 1,25		40 x 19	1/4"	14,95	14,95
M 10 x 1,50		41 x 21	1/4"	18,47	18,47

3 CUTS COUNTERSINKS

HSS-G

Ref. AV22

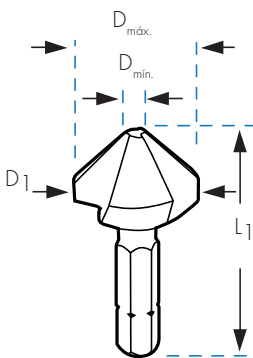

					AV22
D1 mm	L1 mm	D _{min.} - D _{max.} mm		€	
6,30	31	1,50 - 5,8	1/4"	21,57	
8,30	31	2,00 - 7,8	1/4"	21,57	
10,40	34	2,50 - 10,0	1/4"	23,11	
12,40	35	2,80 - 12,0	1/4"	24,66	
16,50	40	3,20 - 16,0	1/4"	26,41	
20,50	41	3,50 - 20,0	1/4"	31,69	

DEBURRING COUNTERSINK

HSS



Ref. AV1...CR

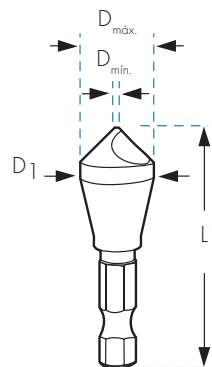

Ref. AV101CR
Ref. AV102CR

Ref. AV103CR
Ref. AV104CR

					AV1...CR
	D1 mm	L1 mm	D _{min.} - D _{max.} mm		€
AV101CR	10,00	40	2,0 - 5,0	1/4"	21,58
AV102CR	14,00	42	5,0 - 10,0	1/4"	26,98
AV103CR	17,00	45	5,0 - 13,0	1/4"	48,31
AV104CR	25,00	55	7,0 - 20,0	1/4"	86,29

These tools are available with hexagonal shank with neck.
* Available HSS 1/4" hexagonal shank step drills with spiral flutes.
See page 156.

1/4" HEXAGONAL SHANK TOOLS

PROFESSIONAL MASONRY DRILL

Ref. BWH

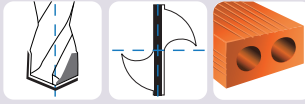



	Ø mm	L1 x L2 mm		BWH €
BWH03	3	70 x 30	1/4"	3,08
BWH04	4	70 x 30	1/4"	3,33
BWH05	5	85 x 45	1/4"	3,61
BWH06	6	100 x 50	1/4"	4,01
BWH07	7	100 x 50	1/4"	4,71
BWH08	8	120 x 70	1/4"	5,45
BWH09	9	120 x 70	1/4"	6,52
BWH10	10	120 x 70	1/4"	7,30
BWH11	11	150 x 80	1/4"	9,09
BWH12	12	150 x 80	1/4"	10,27
BWH13	13	150 x 80	1/4"	12,64
BWH14	14	150 x 80	1/4"	14,72

WOOD WORKING DRILL

Ref. BMH

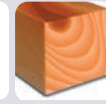
CV



	Ø mm	L1 x L2 mm		BMH €
BMH03	3	59 x 35	1/4"	1,97
BMH04	4	74 x 41	1/4"	2,07
BMH05	5	82 x 55	1/4"	2,05
BMH06	6	88 x 58	1/4"	2,76
BMH07	7	110 x 70	1/4"	3,13
BMH08	8	110 x 70	1/4"	3,26
BMH09	9	110 x 70	1/4"	3,39
BMH10	10	115 x 75	1/4"	3,75
BMH11	11	135 x 85	1/4"	4,38
BMH12	12	135 x 85	1/4"	5,14
BMH13	13	135 x 90	1/4"	8,05
BMH14	14	145 x 95	1/4"	10,01



REFERENCE	BWH9318	BWH9327	BWH9319	BMH9335	BMH9333
QUANTITY	5	5	8	5	8
APPLICATION	CONCRETE	CONCRETE	CONCRETE	WOOD	WOOD
CONTENT	Ø 3 - 4 - 5 - 6 - 8 mm	Ø 4 - 5 - 6 - 8 - 10 mm	Ø 3 - 4 - 5 - 6 - 7 - 8 - 9 - 10 mm	Ø 3 - 4 - 5 - 6 - 8 mm	Ø 3 - 4 - 5 - 6 - 7 - 8 - 9 - 10 mm
PRICE €	25,98	31,35	35,90	16,12	21,27

1/4" HEXAGONAL SHANK DRILL BOXES



Ref. EB



Ref. EMBP

CONTENT

	 HSS-G	 HSS-G			€
EM	M3 - M4 - M5 - M6 M8 - M10	-	-	-	68,75
EMBP	M3 - M4 - M5 - M6 M8 - M10	Ø 2,50 - 3,30 - 4,20 5 - 6,80 - 8,50	-	-	99,12
EBM	-	-	M3 - M4 - M5 - M6 M8 - M10	-	151,34
EA	-	-	-	Ø 6,30 - 8,30 - 10,40 12,40 - 16,50 - 20,50	138,76
EB	-	Ø 1 - 10 mm x 0,50	-	-	115,61