

BLUE-MASTER®
by *celesa*



CORONAS PARA
BASE ELECTROMAGNÉTICA

CORONAS PARA MÁQUINAS CON BASE ELECTROMAGNÉTICA SERIE CORTA
HSS

75
 Kg/mm²

Ref. 250R

30 mm
 CAPACIDAD
 DE CORTE

HSS

75
 Kg/mm²

Ref. 500R

50 mm
 CAPACIDAD
 DE CORTE

VÁLIDAS PARA MÁQUINAS TIPO:

Rota Broach - Alfa Rota Best - Magnetor - Slugger - Dr. Bemder - Bux - Hougen

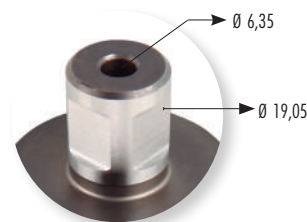
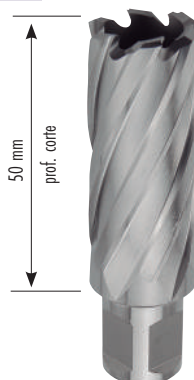
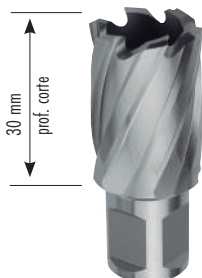
250R

	Ø mm	€
250R12	12	41,13
250R13	13	41,13
250R14	14	42,64
250R15	15	44,42
250R16	16	46,22
250R17	17	47,69
250R18	18	49,48
250R19	19	50,68
250R20	20	53,07
250R21	21	56,65
250R22	22	58,74
250R23	23	61,12
250R24	24	63,51
250R25	25	65,58
250R26	26	67,96
250R27	27	68,57
250R28	28	72,73
250R29	29	75,14
250R30	30	77,21
250R31	31	84,06
250R32	32	90,03
250R33	33	94,79
250R34	34	111,51
250R35	35	123,43
250R36	36	126,41
250R37	37	128,68
250R38	38	129,97
250R39	39	131,16
250R40	40	132,36
250R41	41	134,75
250R42	42	143,70
250R43	43	150,24
250R44	44	155,01
250R45	45	156,81
250R46	46	160,38
250R47	47	163,36
250R48	48	169,93
250R49	49	171,13
250R50	50	181,24

500R

	Ø mm	€
500R12	12	78,56
500R13	13	78,56
500R14	14	59,03
500R15	15	61,40
500R16	16	65,58
500R17	17	67,96
500R18	18	73,04
500R19	19	74,54
500R20	20	76,61
500R21	21	85,26
500R22	22	87,65
500R23	23	90,64
500R24	24	93,31
500R25	25	95,99
500R26	26	98,96
500R27	27	103,74
500R28	28	108,52
500R29	29	112,69
500R30	30	117,46
500R31	31	123,43
500R32	32	128,78
500R33	33	134,75
500R34	34	140,72
500R35	35	146,69
500R36	36	150,84
500R37	37	156,52
500R38	38	160,99
500R39	39	172,91
500R40	40	181,85
500R41	41	184,84
500R42	42	187,22
500R43	43	191,99
500R44	44	194,37
500R45	45	200,33
500R46	46	202,71
500R47	47	214,04
500R48	48	219,41
500R49	49	220,59
500R50	50	225,37

PUNZONES Ø 6,35 mm PARA CORONAS

	DESCRIPCIÓN	L mm	€
P250CA	Punzón normal para coronas Serie 250R/C/T	71	18,40
P250CAA	Utilizar con adaptador a FEIN o NITTO 250R/C/T	101	22,08
P500CA	Punzón normal para coronas Serie 500R/C/T	92	25,88

CORONAS PARA MÁQUINAS CON BASE ELECTROMAGNÉTICA SERIE CORTA

HSSCo
8%

110
Kg/mm²

Ref. 250C

30 mm
CAPACIDAD
DE CORTE

VÁLIDAS PARA MÁQUINAS TIPO:
Rota Broach - Alfa Rota Best - Magnetor - Slugger - Dr. Bemder - Bux - Hougen

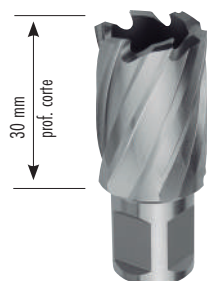

250C		
	Ø mm	€
250C12	12	63,48
250C13	13	63,48
250C14	14	63,48
250C15	15	65,04
250C16	16	65,82
250C17	17	68,12
250C18	18	70,46
250C19	19	72,79
250C20	20	76,65
250C21	21	80,52
250C22	22	82,85
250C23	23	87,11
250C24	24	90,21
250C25	25	94,08
250C26	26	96,79
250C27	27	99,88
250C28	28	103,37
250C29	29	106,47
250C30	30	109,16
250C31	31	118,85
250C32	32	127,22
250C33	33	134,14
250C34	34	135,74
250C35	35	157,11
250C36	36	157,79
250C37	37	169,51
250C38	38	178,48
250C39	39	179,36
250C40	40	181,09
250C41	41	185,07
250C42	42	180,09
250C43	43	187,85
250C44	44	193,81
250C45	45	200,96
250C46	46	207,53
250C47	47	213,49
250C48	48	218,26
250C49	49	247,58
250C50	50	225,42
250C51	51	235,19
250C52	52	242,10
250C53	53	250,74
250C54	54	212,51
250C55	55	230,00
250C56	56	248,83

HSSCo
8%

110
Kg/mm²

Ref. 500C

50 mm
CAPACIDAD
DE CORTE

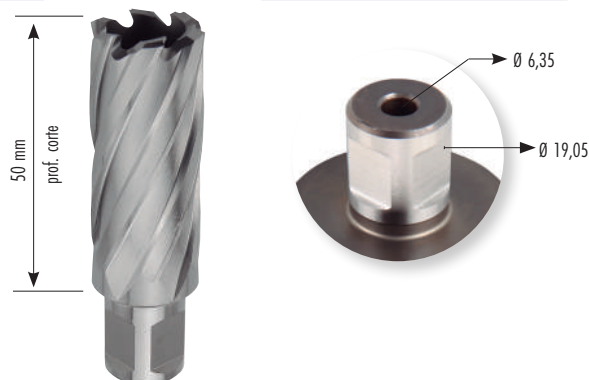

500C		
	Ø mm	€
500C12	12	87,41
500C13	13	82,46
500C14	14	82,46
500C15	15	85,95
500C16	16	92,90
500C17	17	94,08
500C18	18	105,32
500C19	19	108,00
500C20	20	113,43
500C21	21	120,39
500C22	22	123,10
500C23	23	127,35
500C24	24	130,07
500C25	25	135,50
500C26	26	141,10
500C27	27	146,72
500C28	28	142,64
500C29	29	149,54
500C30	30	135,95
500C31	31	143,12
500C32	32	149,08
500C33	33	153,87
500C34	34	159,23
500C35	35	164,00
500C36	36	169,37
500C37	37	172,94
500C38	38	178,89
500C39	39	193,26
500C40	40	199,54
500C41	41	203,93
500C42	42	210,87
500C43	43	218,42
500C44	44	225,97
500C45	45	231,64
500C46	46	239,82
500C47	47	245,48
500C48	48	253,05
500C49	49	321,09
500C50	50	261,23
500C51	51	349,70
500C52	52	355,47
500C53	53	363,15
500C54	54	372,76
500C55	55	380,44
500C56	56	405,42

PUNZONES Ø 6,35 mm PARA CORONAS



	DESCRIPCIÓN	L mm	€
P250CA	Punzón normal para coronas Serie 250R/C/T	71	18,40
P250CAA	Utilizar con adaptador a FEIN o NITTO 250R/C/T	101	22,08
P500CA	Punzón normal para coronas Serie 500R/C/T	92	25,88

CORONAS PARA MÁQUINAS CON BASE ELECTROMAGNÉTICA RECUBIERTA SERIE CORTA
HSSCo
8%

110
 Kg/mm²
TiAIN

Ref. 250T

30 mm
CAPACIDAD
DE CORTE
HSSCo
8%

110
 Kg/mm²
TiAIN

Ref. 500T

50 mm
CAPACIDAD
DE CORTE

VÁLIDAS PARA MÁQUINAS TIPO:

Rota Broach - Alfa Rota Best - Magnetor - Slugger - Dr. Bemder - Bux - Hougen

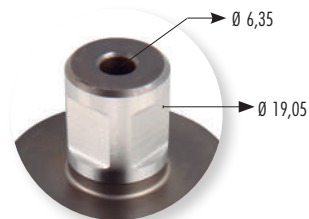
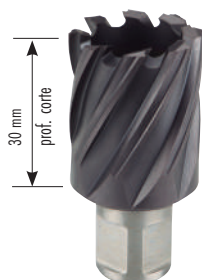

250T		
	Ø mm	€
250T12	12	82,18
250T13	13	82,18
250T14	14	82,18
250T15	15	85,61
250T16	16	85,61
250T17	17	92,25
250T18	18	95,68
250T19	19	97,60
250T20	20	101,46
250T21	21	108,72
250T22	22	113,43
250T23	23	117,52
250T24	24	121,78
250T25	25	126,49
250T26	26	131,22
250T27	27	135,71
250T28	28	139,99
250T29	29	144,48
250T30	30	148,55
250T31	31	162,25
250T32	32	173,81
250T33	33	184,94
250T34	34	196,27
250T35	35	202,90

250T		
	Ø mm	€
250T36	36	213,61
250T37	37	231,16
250T38	38	241,86
250T39	39	252,56
250T40	40	261,12
250T41	41	262,40
250T42	42	274,73
250T43	43	285,03
250T44	44	292,97
250T45	45	302,46
250T46	46	311,20
250T47	47	319,11
250T48	48	325,46
250T49	49	364,42
250T50	50	334,97
250T51	51	347,96
250T52	52	357,14
250T53	53	368,63
250T54	54	398,51
250T55	55	433,93
250T56	56	466,11
250T57	57	495,97
250T58	58	542,77
250T59	59	558,18
250T60	60	562,16

500T		
	Ø mm	€
500T12	12	109,79
500T13	13	109,79
500T14	14	109,79
500T15	15	119,23
500T16	16	127,58
500T17	17	132,28
500T18	18	142,12
500T19	19	145,76
500T20	20	153,25
500T21	21	164,60
500T22	22	169,94
500T23	23	175,72
500T24	24	181,29
500T25	25	187,08
500T26	26	192,40
500T27	27	201,20
500T28	28	209,96
500T29	29	220,47
500T30	30	229,02
500T31	31	239,72
500T32	32	244,01
500T33	33	254,70
500T34	34	263,29
500T35	35	273,98

500T		
	Ø mm	€
500T36	36	282,52
500T37	37	295,38
500T38	38	303,93
500T39	39	312,50
500T40	40	329,63
500T41	41	335,16
500T42	42	343,89
500T43	43	356,18
500T44	44	366,95
500T45	45	376,89
500T46	46	388,88
500T47	47	398,76
500T48	48	408,32
500T49	49	497,26
500T50	50	421,90
500T51	51	514,05
500T52	52	520,57
500T53	53	531,17
500T54	54	544,27
500T55	55	554,94
500T56	56	586,30
500T57	57	638,38
500T58	58	695,19
500T59	59	714,93
500T60	60	731,91

PUNZONES Ø 6,35 mm PARA CORONAS

	DESCRIPCIÓN	L mm	€
P250CA	Punzón normal para coronas Serie 250R/C/T	71	18,40
P250CAA	Utilizar con adaptador a FEIN o NITTO 250R/C/T	101	22,08
P500CA	Punzón normal para coronas Serie 500R/C/T	92	25,88

CORONAS PARA MÁQUINAS CON BASE ELECTROMAGNÉTICA SERIE LARGA

HSSCo
8%

110
Kg/mm²

Ref. 750C

75 mm
CAPACIDAD
DE CORTE

Ref. 1000C

100 mm
CAPACIDAD
DE CORTE

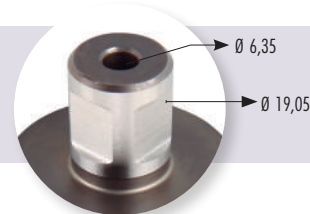

VÁLIDAS PARA MÁQUINAS TIPO:

Rota Broach - Alfa Rota Best - Magnetor - Slugger - Dr. Bemder - Bux - Hougen



750C		
	Ø mm	€
750C50	50	397,49
750C51	51	414,65
750C52	52	418,48
750C53	53	422,21
750C54	54	427,32
750C55	55	434,11
750C56	56	442,32
750C57	57	446,58
750C58	58	456,73
750C59	59	467,65
750C60	60	491,24
750C61	61	510,66
750C62	62	525,33
750C63	63	535,29
750C64	64	549,00
750C65	65	562,71
750C66	66	703,03
750C67	67	719,42
750C68	68	734,70
750C69	69	746,57
750C70	70	756,28
750C71	71	767,03
750C72	72	779,58
750C73	73	791,46
750C74	74	801,94
750C75	75	810,94
750C76	76	820,40
750C77	77	827,76
750C78	78	836,08
750C79	79	853,24
750C80	80	876,32
750C81	81	902,45
750C82	82	911,46
750C83	83	938,33
750C84	84	958,52
750C85	85	982,22
750C86	86	1.011,63
750C87	87	1.040,92
750C88	88	1.058,17
750C89	89	1.083,30
750C90	90	1.106,94
750C91	91	1.143,95
750C92	92	1.177,31
750C93	93	1.202,36
750C94	94	1.239,78
750C95	95	1.275,05
750C96	96	1.295,15
750C97	97	1.322,10
750C98	98	1.348,26
750C99	99	1.370,27
750C100	100	1.394,12

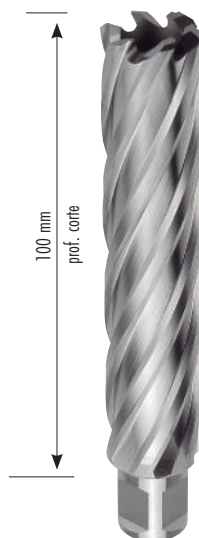

1000C		
	Ø mm	€
1000C18	18	161,09
1000C19	19	169,32
1000C20	20	177,57
1000C21	21	187,65
1000C22	22	195,72
1000C23	23	201,16
1000C24	24	210,84
1000C25	25	212,45
1000C26	26	213,96
1000C27	27	216,35
1000C28	28	226,36
1000C29	29	235,56
1000C30	30	246,99
1000C31	31	251,15
1000C32	32	257,63
1000C33	33	275,38
1000C34	34	279,31
1000C35	35	283,86
1000C36	36	291,77
1000C37	37	301,61
1000C38	38	308,90
1000C39	39	316,42
1000C40	40	326,26
1000C41	41	338,18
1000C42	42	364,09
1000C43	43	382,88
1000C44	44	402,00
1000C45	45	418,64
1000C46	46	436,47
1000C47	47	459,19
1000C48	48	481,74
1000C49	49	498,87

1000C		
	Ø mm	€
1000C50	50	506,13
1000C51	51	512,30
1000C52	52	514,94
1000C53	53	517,02
1000C54	54	520,14
1000C55	55	525,74
1000C56	56	531,57
1000C57	57	535,42
1000C58	58	548,61
1000C59	59	560,70
1000C60	60	584,05
1000C61	61	594,36
1000C62	62	610,44
1000C63	63	620,35
1000C64	64	636,75
1000C65	65	646,51
1000C66	66	749,05
1000C67	67	764,97
1000C68	68	779,21
1000C69	69	795,85
1000C70	70	802,08
1000C71	71	817,60
1000C72	72	829,28
1000C73	73	840,16
1000C74	74	849,60
1000C75	75	859,75
1000C76	76	870,88
1000C77	77	875,27
1000C78	78	879,75
1000C79	79	898,71
1000C80	80	919,98
1000C81	81	941,34
1000C82	82	957,82
1000C83	83	976,85
1000C84	84	999,81
1000C85	85	1.193,31
1000C86	86	1.239,41
1000C87	87	1.266,75
1000C88	88	1.294,00
1000C89	89	1.318,44
1000C90	90	1.353,72
1000C91	91	1.395,16
1000C92	92	1.432,76
1000C93	93	1.465,70
1000C94	94	1.515,26
1000C95	95	1.551,64
1000C96	96	1.577,68
1000C97	97	1.608,93
1000C98	98	1.637,12
1000C99	99	1.663,24
1000C100	100	1.702,07

PUNZONES Ø 6,35 mm PARA CORONAS



	DESCRIPCIÓN	L mm	€
P750CA	Punzón normal para coronas Serie 750C	123	28,35
P1000CA	Punzón normal para coronas Serie 1000C	147	40,62
P1000CAA	Utilizar con adaptador a FEIN o Nitto 1000C	177	34,02

CORONAS PARA MÁQUINAS CON BASE ELECTROMAGNÉTICA SERIE EXTRALARGA
HSS

Ref. 1500C

150 mm
 CAPACIDAD
 DE CORTE

HSS

Ref. 2000C

200 mm
 CAPACIDAD
 DE CORTE

1500C

	Ø mm	€
1500C22	22	516,10
1500C24	24	555,96
1500C26	26	564,19
1500C28	28	596,87
1500C30	30	651,28
1500C32	32	741,25
1500C34	34	803,62
1500C36	36	839,51
1500C38	38	888,77
1500C40	40	938,71
1500C42	42	1.047,55
1500C44	44	1.156,66
1500C46	46	1.255,83
1500C48	48	1.386,07
1500C50	50	1.456,28
1500C52	52	1.648,48
1500C54	54	1.765,33
1500C55	55	1.800,64

2000C

	Ø mm	€
2000C26	26	784,21
2000C28	28	829,67
2000C30	30	905,29
2000C32	32	1.030,33
2000C34	34	1.117,02
2000C36	36	1.247,27
2000C38	38	1.320,44
2000C40	40	1.394,62
2000C42	42	1.556,34
2000C44	44	1.718,42
2000C46	46	1.865,77
2000C48	48	2.111,56
2000C50	50	2.218,47
2000C52	52	2.320,21
2000C54	54	2.391,59

PUNZONES Ø 8 mm PARA CORONAS

	DESCRIPCIÓN	L mm	€
P1500CA	Punzón normal para coronas Serie 1500C	220	48,67
P2000CA	Punzón normal para coronas Serie 2000C	248	61,66
P2500CA	Punzón EXTRA largo para uso de coronas con alargadores	310	72,03

CORONAS PARA TALADROS DE BASE ELECTROMAGNÉTICA CON DIENTES DE METAL DURO

35 mm
CAPACIDAD
DE CORTE

50 mm
CAPACIDAD
DE CORTE

MD



INOX

Al



Cu-Ni-La

FUNDICIÓN



Ref. 350A

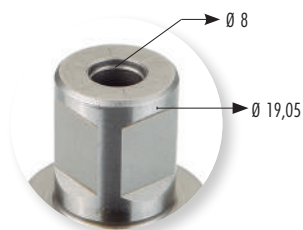

MANGO
DOBLE WELDON

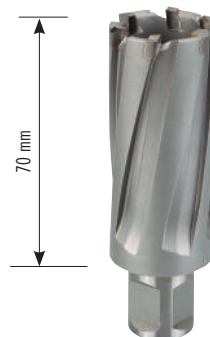

Ref. 500A

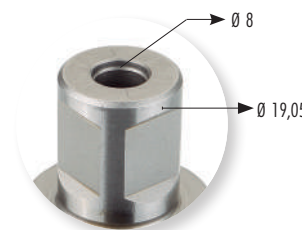

MANGO
DOBLE WELDON

35 mm PROFUNDIDAD DE CORTE

350A		
	Ø mm	€
350A12	12,0	119,84
350A13	13,0	120,97
350A14	14,0	120,98
350A15	15,0	120,98
350A16	16,0	120,98
350A17	17,0	120,98
350A17,5*	17,5	78,41
350A18	18,0	120,98
350A19	19,0	120,98
350A20	20,0	120,98
350A21	21,0	120,98
350A21,5*	21,5	84,14
350A22	22,0	129,81
350A22,5*	22,5	84,14
350A23	23,0	129,81
350A23,5*	23,5	84,14
350A24	24,0	129,81
350A24,5*	24,5	84,14
350A25	25,0	129,81

350A		
	Ø mm	€
350A26	26,0	129,81
350A26,5*	26,5	84,14
350A27	27,0	129,81
350A28	28,0	129,81
350A29	29,0	129,81
350A30	30,0	129,81
350A31	31,0	144,58
350A32	32,0	144,58
350A33	33,0	144,58
350A34	34,0	144,58
350A35	35,0	144,58
350A36	36,0	144,58
350A37	37,0	144,58
350A38	38,0	144,58
350A39	39,0	165,23
350A40	40,0	167,30
350A41	41,0	169,36
350A42	42,0	171,43
350A43	43,0	173,49
350A44	44,0	175,56
350A45	45,0	177,62
350A46	46,0	179,69
350A47	47,0	181,76
350A48	48,0	183,83
350A49	49,0	185,89
350A50	50,0	187,95
350A51	51,0	190,02
350A52	52,0	192,08

50 mm PROFUNDIDAD DE CORTE

500A		
	Ø mm	€
500A14	14,0	135,94
500A15	15,0	135,94
500A16	16,0	135,94
500A17	17,0	135,94
500A17,5*	17,5	88,11
500A18	18,0	135,94
500A19	19,0	135,94
500A20	20,0	135,94
500A21	21,0	135,94
500A21,5*	21,5	94,26
500A22	22,0	145,42
500A22,5*	22,5	94,26
500A23	23,0	145,42
500A23,5*	23,5	94,26
500A24	24,0	145,42
500A24,5*	24,5	94,26
500A25	25,0	145,42
500A26	26,0	145,42
500A26,5*	26,5	94,26
500A27	27,0	145,42
500A28	28,0	145,42
500A29	29,0	145,42
500A30	30,0	145,42
500A31	31,0	161,23
500A32	32,0	161,23
500A33	33,0	161,23
500A34	34,0	161,23
500A35	35,0	161,23
500A36	36,0	184,91
500A37	37,0	184,91
500A38	38,0	184,91
500A39	39,0	184,91

500A		
	Ø mm	€
500A40	40,0	184,91
500A41	41,0	216,54
500A42	42,0	216,54
500A43	43,0	216,54
500A44	44,0	216,54
500A45	45,0	216,54
500A46	46,0	240,25
500A47	47,0	240,25
500A48	48,0	240,25
500A49	49,0	240,25
500A50	50,0	240,25
500A51	51,0	265,53
500A52	52,0	265,53
500A53	53,0	265,53
500A54	54,0	265,53
500A55	55,0	265,53
500A56	56,0	300,30
500A57	57,0	300,30
500A58	58,0	300,30
500A59	59,0	300,30
500A60	60,0	300,30
500A61	61,0	347,72
500A62	62,0	347,72
500A63	63,0	347,72
500A64	64,0	347,72
500A65	65,0	347,72
500A66	66,0	368,79
500A67	67,0	368,79
500A68	68,0	368,79
500A69	69,0	368,79
500A70	70,0	368,79

Mango 32 mm

- El encuentro de la corona en el material debe ser sutil, sin choques ni empujes bruscos.
- Lubricar con CUT-MAGIC o similares.

*Hasta fin de existencias

PUNZONES PARA CORONAS DIENTES METAL DURO



Ref. P350AA



Ref. P350AA-1

	DESCRIPCIÓN	Ø x L mm	€
P350AA	Coronas 350A Ø 12 - 15 mm	Ø 5 x 91	21,24
P350AA-1	Coronas 350A Ø 16 - 52 mm	Ø 8 x 91	21,56
P500AA	Coronas 500A Ø 14 - 16 mm	Ø 5 x 112	24,69
P500AA	Coronas 500A Ø 17 - 70 mm	Ø 8 x 112	24,19

CORONAS PARA TALADROS DE BASE ELECTROMAGNÉTICA CON DIENTES DE METAL DURO
75 mm
 CAPACIDAD
 DE CORTE

100 mm
 CAPACIDAD
 DE CORTE

MD



INOX

Al



Cu-Ni-La

FUNDICIÓN

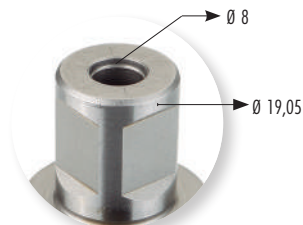
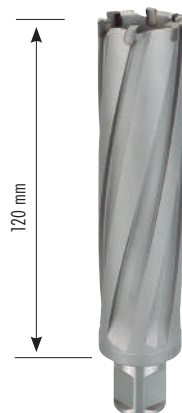

Ref. 750A

MANGO
DOBLE WELDON

Ref. 1000A

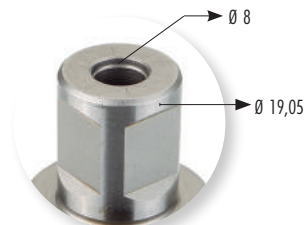
MANGO
DOBLE WELDON
75 mm PROFUNDIDAD DE CORTE

750A		750A
	Ø mm	€
750A17	17	173,12
750A18	18	208,42
750A19	19	208,42
750A20	20	208,42
750A21	21	208,42
750A22	22	222,98
750A23	23	222,98
750A24	24	222,98
750A25	25	222,98
750A26	26	222,98
750A27	27	222,98
750A28	28	222,98
750A29	29	222,98
750A30	30	222,98
750A31	31	247,22
750A32	32	247,22
750A33	33	247,22
750A34	34	247,22
750A35	35	247,22
750A36	36	283,55
750A37	37	283,55
750A38	38	283,55
750A39	39	283,55
750A40	40	283,55
750A41	41	332,04
750A42	42	332,04
750A43	43	332,04
750A44	44	332,04
750A45	45	332,04
750A46	46	368,38
750A47	47	368,38
750A48	48	368,38
750A49	49	368,38
750A50	50	368,38
750A51	51	407,14

750A		750A
	Ø mm	€
750A52	52	407,14
750A53	53	407,14
750A54	54	407,14
750A55	55	407,14
750A56	56	460,47
750A57	57	460,47
750A58	58	460,47
750A59	59	460,47
750A60	60	460,47
750A61	61	533,17
750A62	62	533,17
750A63	63	533,17
750A64	64	533,17
750A65	65	533,17
750A66	66	533,17
750A67	67	533,17
750A68	68	533,17
750A69	69	533,17
750A70	70	533,17
750A75	75	623,21
750A80	80	658,52
750A85	85	714,41
750A90	90	784,59
750A95	95	819,47
750A100	100	896,37
750A105	105	1.232,56
750A110	110	1.232,56
750A115	115	1.589,77
750A120	120	1.589,77
750A125	125	2.045,30
750A130	130	2.156,36
750A135	135	2.342,67
750A140	140	2.342,67
750A145	145	2.965,60
750A150	150	2.965,60

Mango 32 mm

100 mm PROFUNDIDAD DE CORTE

1000A		1000A
	Ø mm	€
1000A18	18	235,13
1000A19	19	235,13
1000A20	20	235,13
1000A21	21	235,13
1000A22	22	241,70
1000A23	23	241,70
1000A24	24	241,70
1000A25	25	256,42
1000A26	26	256,42
1000A27	27	256,42
1000A28	28	256,42
1000A29	29	256,42
1000A30	30	256,42
1000A31	31	284,30
1000A32	32	284,30
1000A33	33	284,30
1000A34	34	284,30
1000A35	35	293,70
1000A36	36	326,07
1000A37	37	326,07
1000A38	38	326,07
1000A39	39	326,07
1000A40	40	345,40
1000A41	41	381,84
1000A42	42	381,84
1000A43	43	420,03
1000A44	44	420,03
1000A45	45	420,03
1000A46	46	466,00
1000A47	47	466,00
1000A48	48	466,00
1000A49	49	466,00
1000A50	50	485,81

1000A		1000A
	Ø mm	€
1000A51	51	515,04
1000A52	52	515,04
1000A53	53	515,04
1000A54	54	515,04
1000A55	55	515,04
1000A56	56	582,49
1000A57	57	582,49
1000A58	58	582,49
1000A59	59	582,49
1000A60	60	582,49
1000A61	61	674,46
1000A62	62	674,46
1000A63	63	674,46
1000A64	64	674,46
1000A65	65	674,46
1000A66	66	674,46
1000A67	67	777,54
1000A68	68	777,54
1000A69	69	777,54
1000A70	70	777,54
1000A75	75	777,54
1000A80	80	717,50
1000A85	85	811,94
1000A90	90	850,99
1000A95	95	890,03
1000A100	100	940,09
1000A105	105	1.323,86
1000A110	110	1.323,86
1000A115	115	1.768,72
1000A120	120	1.768,72
1000A125	125	2.267,63
1000A130	130	2.267,63
1000A135	135	2.836,62
1000A140	140	2.836,62
1000A145	145	3.810,09
1000A150	150	3.810,09

Mango 32 mm

PUNZONES PARA CORONAS DIENTES METAL DURO

	DESCRIPCIÓN	Ø x L mm	€
P750AA	Coronas 750A Ø 17 - 70 mm	Ø8x140	33,31
P750AA-1	Coronas 750A Ø 75 - 150 mm	Ø8x160	39,12
P1000AA	Coronas 1000A Ø 25 - 70 mm	Ø8x160	43,39
P1000AA-1	Coronas 1000A Ø 75 - 150 mm	Ø8x190	50,87

**CORONAS ESPECIALES PARA MÁQUINAS CON BASE ELECTROMAGNÉTICA Ø MANGO DE 19,05 mm
ESPECIAL PARA RAILES DE FERROCARRIL, HARDOX ...**



- Dientes de metal duro.
- Para materiales extremadamente duros.
- Posibilidad de trabajo en taladros, fresadoras y tornos.
- Posibilidad de trabajo con Cono Morse de acople rápido.



Ref. MB250AT
Ref. MB500AT

HSSCo
8%

TiAIN

HARDOX
450

HARDOX
500

Ref. MB350ST
Ref. MB500ST

MD

HARDOX
450

HARDOX
500

HARDOX
600

25 mm
CAPACIDAD
DE CORTE



Ref. MB250AT

25 mm PROF. DE CORTE

50 mm
CAPACIDAD
DE CORTE



Ref. MB500AT

50 mm PROF. DE CORTE

35 mm
CAPACIDAD
DE CORTE

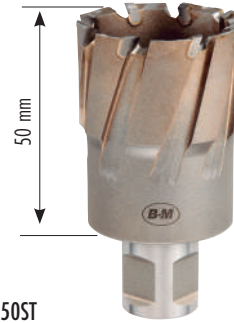

Ref. MB350ST

35 mm PROF. DE CORTE

50 mm
CAPACIDAD
DE CORTE

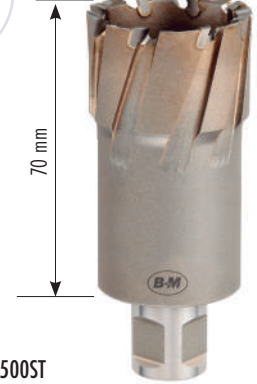

Ref. MB500ST

50 mm PROF. DE CORTE

MB250AT		
	Ø mm	€
MB250AT16	16	137,11
MB250AT18	18	141,04
MB250AT20	20	144,97
MB250AT22	22	151,44
MB250AT24	24	156,87
MB250AT26	26	161,91
MB250AT28	28	167,12
MB250AT30	30	172,39
MB250AT32	32	202,41

MB500AT		
	Ø mm	€
MB500AT16	16	171,05
MB500AT18	18	180,20
MB500AT20	20	189,33
MB500AT22	22	197,22
MB500AT24	24	203,67
MB500AT26	26	210,20
MB500AT28	28	220,69
MB500AT30	30	233,70
MB500AT32	32	257,84

MB350ST		
	Ø mm	€
MB350ST18	18	154,94
MB350ST19	19	154,94
MB350ST20	20	154,94
MB350ST21	21	156,02
MB350ST22	22	166,27
MB350ST23	23	166,26
MB350ST24	24	166,27
MB350ST25	25	166,26
MB350ST26	26	166,27
MB350ST27	27	166,26
MB350ST28	28	166,27
MB350ST29	29	166,26
MB350ST30	30	166,27
MB350ST31	31	166,26
MB350ST32	32	185,17
MB350ST33	33	185,17
MB350ST34	34	185,17
MB350ST35	35	185,17
MB350ST36	36	185,17

MB500ST		
	Ø mm	€
MB500ST37	37	217,32
MB500ST38	38	217,32
MB500ST39	39	217,32
MB500ST40	40	217,32
MB500ST41	41	233,85
MB500ST42	42	233,85
MB500ST43	43	233,85
MB500ST44	44	233,85
MB500ST45	45	233,85
MB500ST46	46	272,94
MB500ST47	47	272,94
MB500ST48	48	272,94
MB500ST49	49	272,94
MB500ST50	50	272,94

PUNZONES Ø 6,35 mm
CORONAS Ref. MB250AT y MB500AT



	DESCRIPCIÓN	L mm	€
P250CA	Coronas MB250AT Ø16-32 mm	71	18,40
P500CA	Coronas MB500AT Ø16-32 mm	92	25,88

PUNZONES
CORONAS Ref. MB350ST Y Ref. MB500ST



	DESCRIPCIÓN	Ø x L mm	€
P350AA-1	Coronas MB350ST Ø18-36 mm	Ø8x91	21,56
P500AA	Coronas MB500ST Ø37-50 mm	Ø8x112	24,19

BROCAS, BROCA-MACHO Y ACCESORIOS PARA MÁQUINAS CON BASE ELECTROMAGNÉTICA
HSS

BROCA

Ref. BMG

HSS

BROCA-MACHO

Ref. MBE

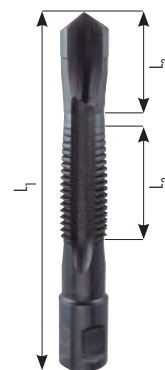

		BMG		BMGL	
	Ø mm	L2 mm	€	L2 mm	€
BMG0600	6,00	25	40,20	50	50,25
BMG0675	6,75	25	40,20	50	
BMG0700	7,00	25	40,20	50	50,25
BMG0800	8,00	25	40,20	50	50,25
BMG0850	8,50	25	40,20	50	
BMG0900	9,00	25	40,20	50	50,25
BMG1000	10,00	25	42,35	50	52,93
BMG1020	10,20	25	42,35	50	
BMG1100	11,00	25	42,35	50	52,93
BMG1200	12,00	25	42,35	50	52,93
BMG1300	13,00	25	45,35	50	60,31
BMG1400	14,00	25	46,20	50	61,45
BMG1500	15,00	25	46,63	50	62,96
BMG1600	16,00	25	57,55	50	71,94

			MBE	
	Ø	L1 x L2 x L3 mm	ROSCA	€
MBE8M08X1,25	6,75	110x12,5x15	M8 x 1,25	79,10
MBE8M10X1,50	8,50	113x15,0x15	M10 x 1,50	79,10
MBE8M12X1,75	10,20	117x18,0x16	M12 x 1,75	79,10
MBE8M14X2,00	12,00	117x20,0x16	M14 x 2,00	79,10
MBE8M16X2,00	14,00	117x20,0x16	M16 x 2,00	79,10
MBE8M18X2,50	15,50	130x25,0x16	M18 x 2,50	79,10
MBE8M20X2,50	17,50	135x25,0x16	M20 x 2,50	87,97
MBE8M22X2,50	19,50	135x25,0x17	M22 x 2,50	94,04
MBE8M24X3,00	21,00	148x30,0x17	M24 x 3,00	125,58
MBE8M27X3,00	24,00	155x30,0x18	M27 x 3,00	160,44
MBE8M30X3,50	26,50	169x63,0x19	M30 x 3,50	182,56

HSS

AVELLANADOR

Ref. ABE

90°



	ABE	
	Ø mm	€
ABE25	25	98,55
ABE30	30	101,09
ABE40	40	114,83
ABE50	50	177,83
ABE55	55	194,96
ABE63	63	248,46



BROCAS AVELLANADORAS Y ACCESORIOS PARA MÁQUINAS CON BASE ELECTROMAGNÉTICA

HSS

BROCA AVELLANADORA ESCALONADA

Ref. MBE

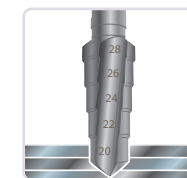

Varias medidas de agujero en una sola herramienta.

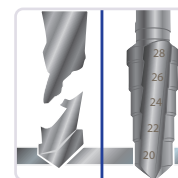

Diseño más compacto que alarga la vida de la herramienta y evita incómodas roturas.

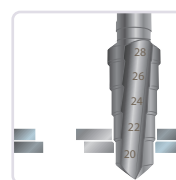

Puede taladrar dos piezas separadas, capaz de alinear 2 agujeros no coaxiales.

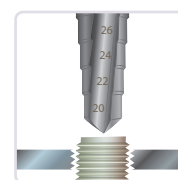

Agranda agujeros con facilidad.

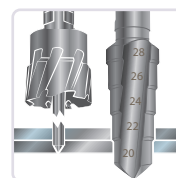

Taladra sobre conjuntos de chapas, sin peligro de rotura, como sucede con las coronas.



No se necesitan accesorios como el punzón guía para su uso.

MBE					
	Ø Z mm menor-mayor	Geometría	Z	Lz mm	€
MBE08-16	8 - 10 - 12 - 14 - 16	Tipo A	5	12	43,70
MBE10-18	10 - 12 - 14 - 16 - 18	Tipo A	5	12	48,37
MBE20-28	20 - 22 - 24 - 26 - 28	Tipo A	5	12	68,94
MBE30-38	30 - 32 - 34 - 36 - 38	Tipo B	5	12	107,32
MBE40-48	40 - 42 - 44 - 46 - 48	Tipo B	5	12	153,73
MBE10-14	10 - 12 - 14	Tipo A	3	25	37,15
MBE16-20	16 - 18 - 20	Tipo A	3	25	53,01
MBE22-26	22 - 24 - 26	Tipo B	3	25	63,63
MBE28-32	28 - 30 - 32	Tipo B	3	25	86,15
MBE34-38	34 - 36 - 38	Tipo B	3	25	107,35
MBE40-44	40 - 42 - 44	Tipo B	3	25	132,51
MBE46-50	46 - 48 - 50	Tipo B	3	25	159,04

Geometría Tipo A: Con punta y corte al centro.

Geometría Tipo B: Sin punta y sin corte al centro. Sólo agranda orificios previamente hechos.

HSS

ADAPTADOR DOBLE WELDON 19,05 A HEX 1/4"

Ref. MBE



Ref. MBEHEX1/4

MBEHEX1/4		
	DESCRIPCIÓN	€
MBEHEX1/4	DOBLE WELDON 19,05 a 1/4"HEX	16,36

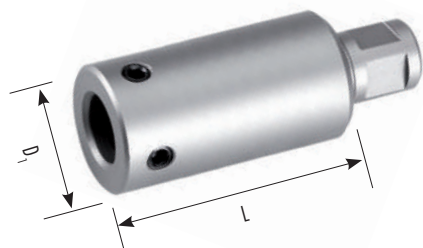
ALARGADORES PARA CORONAS PARA TALADROS DE BASE ELECTROMAGNÉTICA
MANGO: 19,05 mm DOBLE WELDON
SALIDA: 19,05 mm WELDON

ACRWX			
	L mm	D1 mm	€
ACRWX75	75	35	39,04
ACRWX100	100	35	86,67
ACRWX150	150	35	114,40
ACRWX200	200	35	154,85
ACRWX250	250	35	192,99

Este adaptador alberga en su interior un punzón alargador que posibilita usar las coronas de HSS/HSSCo con el punzón original, sin necesidad de cambiarlo por uno extra largo. En el caso de usar coronas de dientes de Metal duro, cuyo punzón es de 8mm, sí debemos cambiar el punzón a uno más largo, como P1500CA, P2000CA o P2500CA.

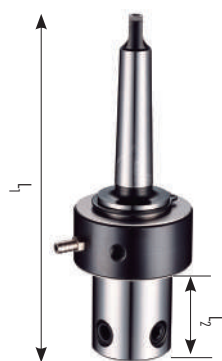
CONOS MORSE PARA TALADROS DE BASE ELECTROMAGNÉTICA Y TALADROS DE COLUMNA

Ref. CMN°2



Ref. CMN°2SR



Ref. CMN°2CR



Ref. CMN°3



Ref. CMN°3SR



Ref. CMN°3x32



Ref. CMN°4x32



	L2 mm	L1 mm	CM	Salida	Refrigeración	€
CMN°2	43	158	2	19,05	SI	162,52
CMN°2SR	43	158	2	19,05	NO	105,64
CMN°2CR	43	158	2	19,05 Cambio Rápido	SI	275,75
CMN°3	43	177	3	19,05	SI	162,52
CMN°3SR	43	177	3	19,05	NO	105,64
CMN°3CR	43	177	3	19,05 Cambio Rápido	SI	275,75
CMN°4	80	250	4	19,05	SI	209,65
CMN°5	80	270	5	19,05	SI	228,69
CMN°3x32	116	229	3	32,00	SI	239,68
CMN°4x32	116	250	4	32,00	SI	299,47

ADAPTADORES A OTRO TIPO DE MANGO



ACR18W

MANGO: 18 mm FEIN
SALIDA: 19,05 mm DOBLE WELDON



ACRWB16

MANGO: NITTO
SALIDA: 19,05 mm DOBLE WELDON



ACR18W
39,04 €

MANGO: 19,05 mm DOBLE WELDON
SALIDA: ROSCA M18 X 6 P1,5



ACR NITTO
39,04 €

MANGO: 19,05 mm DOBLE WELDON
SALIDA: B16



ACRWM18X6P1,5
39,04 €

MANGO: NITTO
SALIDA: ROSCA M18 X 6 P1,5



ACRWB16
39,04 €

MANGO: 18 mm FEIN
SALIDA: B16



ACRNM18X6P1,5
39,04 €

MANGO: 19,05 mm DOBLE WELDON
SALIDA: 1/2 X 20 UNF



ACR18B16
39,04 €

MANGO: NITTO / 19,05 mm DOBLE WELDON
SALIDA: B16



ACRW1/2X20
39,04 €

MANGO: NITTO / 19,05 mm DOBLE WELDON
SALIDA: 1/2 X 20 UNF



ACRNB16
39,04 €

MANGO: 19,05 mm DOBLE WELDON
SALIDA: 32 mm DOBLE WELDON



ACRN1/2X20
39,04 €

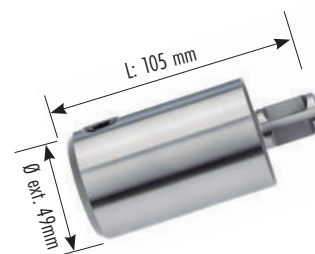

ACRWX32
38,97 €

ESTUCHES Y EXPOSITORES DE METACRILATO CON CORONAS PARA MÁQUINAS CON BASE ELECTROMAGNÉTICA

Coronas

Rosca



	Contenido:		€
NEW			
EFB250R1	6 Coronas Ref. 250R: Ø 12 - 14 - 16 - 18 - 20 - 22 mm 2 Punzones Ref. P250CA	HSS	331,08
EFB250C1	6 Coronas Ref. 250C: Ø 12 - 14 - 16 - 18 - 20 - 22 mm 2 Punzones Ref. P250CA	HSSCo	462,54
EFB500R1	6 Coronas Ref. 500R: Ø 12 - 14 - 16 - 18 - 20 - 22 mm 2 Punzones Ref. P500CA	HSS	495,23
EFB500C1	6 Coronas Ref. 500C: Ø 12 - 14 - 16 - 18 - 20 - 22 mm 2 Punzones Ref. P500CA	HSSCo	659,38
EFB500R5	6 Coronas Ref. 500R: Ø 14 - 16 - 18 - 20 - 22 - 24 mm 2 Punzones Ref. P500CA	HSS	509,98
EFB500C5	6 Coronas Ref. 500C: Ø 14 - 16 - 18 - 20 - 22 - 24 mm 2 Punzones Ref. P500CA	HSSCo	702,04

NEW

	Contenido:		€
EFBBMG1	6 Coronas Ref. BMG: Ø 6 - 8 - 10 - 12 - 14 - 16 mm	HSS	271,85
EFBBMG2	3 Coronas Ref. BMG: Ø 6 - 8 - 10 mm 3 Coronas Ref. 250R: Ø 12 - 14 - 16 mm 2 Punzones Ref. P250CA	HSS	292,54
EFBBMG3	3 Coronas Ref. BMG: Ø 6 - 8 - 10 mm 3 Coronas Ref. 250C: Ø 12 - 14 - 16 mm 2 Punzones Ref. P250CA	HSSCo	355,33



Dimensiones: 210 x 210 x 210 mm

Contenido: 20 Coronas		CFBE01
HSS	Ref. 250R: Ø 14 - 16 - 18 - 20 - 22 - 24 - 26 - 28 - 30 - 32 mm Ref. 500R: Ø 14 - 16 - 18 - 20 - 22 - 24 - 26 - 28 - 30 - 32 mm	
		1.530,53 €
Contenido: 20 Coronas		CFBE02
HSSCo	Ref. 250C: Ø 14 - 16 - 18 - 20 - 22 - 24 - 26 - 28 - 30 - 32 mm Ref. 500C: Ø 14 - 16 - 18 - 20 - 22 - 24 - 26 - 28 - 30 - 32 mm	
		2.102,06 €
Contenido: 18 Coronas		CFBE03
MD	Ref. 350A: Ø 14 - 16 - 18 - 20 - 22 - 24 - 26 - 28 - 30 - 32 mm Ref. 500A: Ø 18 - 20 - 22 - 24 - 26 - 28 - 30 - 32 mm	
		2.437,76 €

DIAGRAMA EXPLICATIVO DE ACCESORIOS SOBRE CORONAS PARA TALADROS DE BASE ELECTROMAGNÉTICA

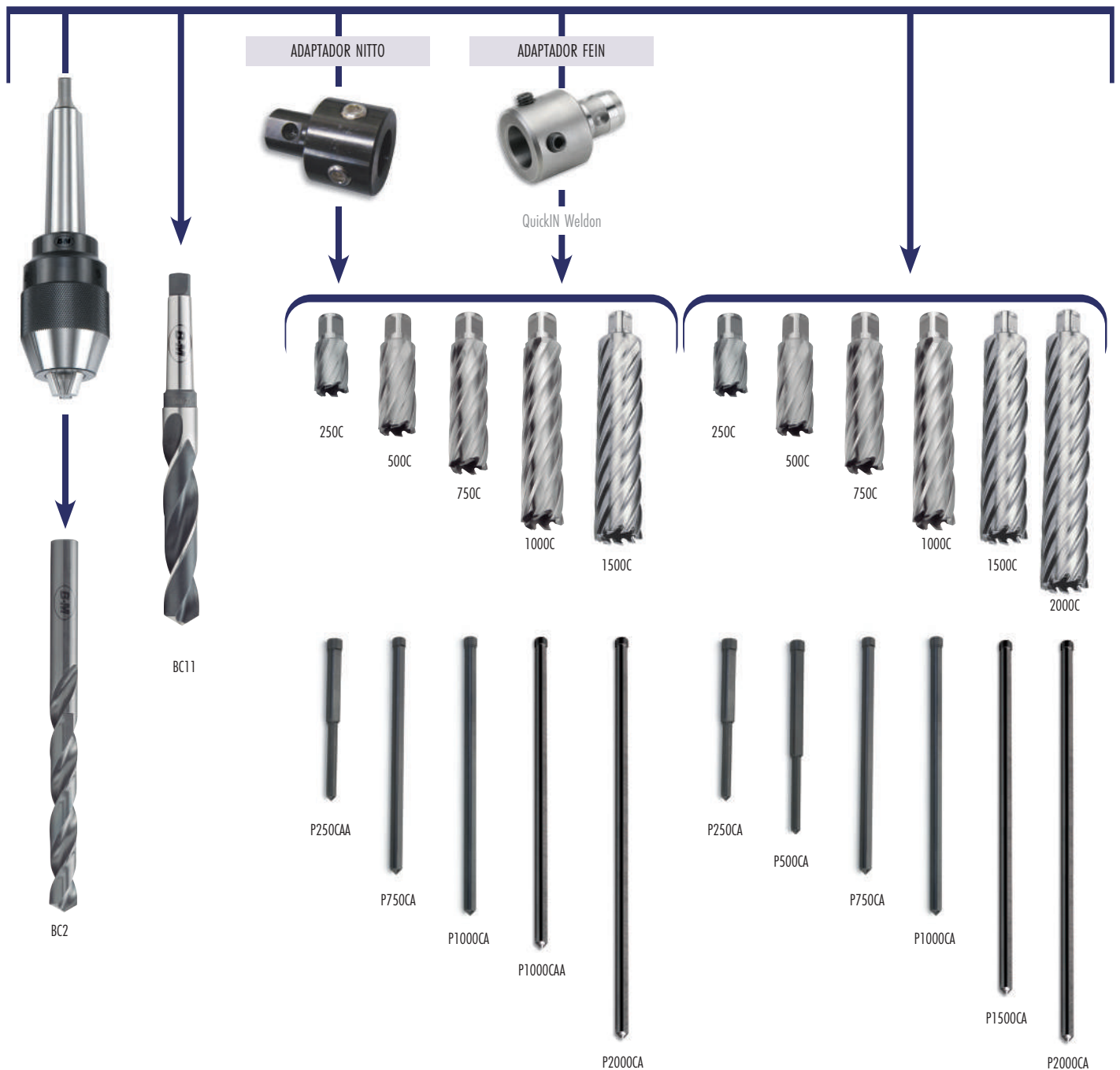

CONDICIONES DE CORTE PARA CORONAS PARA TALADROS CON BASE ELECTROMAGNÉTICA

mm/VUELTA							
		INOX	FUNDICIÓN	Al	Ni		
250R - 500R - 1500C - 2000C	0,053	-	0,05	0,075	0,12	-	
250C - 500C - 750C - 1000C - MB350AT - MB500AT	0,063	-	0,055	0,085	0,15	-	
350A - 500A - 750A - 1000A - MB350ST - MB500ST	0,10	0,075	0,10	0,15	0,22	0,07	

SELECCIÓN DE R.P.M. PARA CORONAS 250R - 500R - 250C - 500C - 750C - 1000C - 1500C - 2000C

100	3183	2122	1952	1273	1061	909	796	637	531	455	398	354	318
95	3024	2016	1512	1512	1008	864	756	605	504	432	378	336	302
90	2865	1910	1432	1432	955	819	716	573	477	409	358	318	286
85	2706	1804	1353	1353	902	773	676	541	451	387	338	301	271
80	2547	1698	1273	1276	849	728	637	509	424	364	318	283	255
75	2387	1592	1194	1194	796	682	597	477	398	341	298	265	239
70	2228	1485	1114	1114	743	637	557	446	371	318	279	248	223
65	2069	1379	1035	1035	690	591	517	414	345	296	259	230	207
60	1910	1273	955	922	637	546	477	382	318	273	239	212	191
55	1751	1167	875	875	584	500	438	350	292	250	219	195	175
50	1592	1061	796	796	531	455	398	318	265	227	199	177	159
45	1432	955	716	716	477	409	658	286	239	205	179	159	143
40	1273	849	637	637	424	364	618	255	212	192	159	141	127
35	1114	743	557	557	371	318	279	223	186	159	139	124	111
30	955	637	477	477	318	273	239	191	159	136	119	106	95
25	796	531	398	398	265	227	199	159	133	114	99	88	80
20	637	424	318	318	212	182	159	127	106	91	80	71	64
15	477	318	239	239	159	136	119	95	80	68	60	53	48
10	318	212	159	159	106	91	80	64	53	45	40	35	32
	10	15	20	25	30	35	40	50	60	70	80	90	100

SELECCIÓN DE DIÁMETRO (Ø mm)

SELECCIÓN DE R.P.M. PARA CORONAS 350A - 500A - 750A - 1000A - MB350ST - MB500ST

100	3183	2122	1952	1273	1061	909	796	637	531	455	398	354	318
95	3024	2016	1512	1512	1008	864	756	605	504	432	378	336	302
90	2865	1910	1432	1432	955	819	716	573	477	409	358	318	286
85	2706	1804	1353	1353	902	773	676	541	451	387	338	301	271
80	2547	1698	1273	1276	849	728	637	509	424	364	318	283	255
75	2387	1592	1194	1194	796	682	597	477	398	341	298	265	239
70	2228	1485	1114	1114	743	637	557	446	371	318	279	248	223
65	2069	1379	1035	1035	690	591	517	414	345	296	259	230	207
60	1910	1273	955	922	637	546	477	382	318	273	239	212	191
55	1751	1167	875	875	584	500	438	350	292	250	219	195	175
50	1592	1061	796	796	531	455	398	318	265	227	199	177	159
45	1432	955	716	716	477	409	658	286	239	205	179	159	143
40	1273	849	637	637	424	364	618	255	212	192	159	141	127
35	1114	743	557	557	371	318	279	223	186	159	139	124	111
30	955	637	477	477	318	273	239	191	159	136	119	106	95
25	796	531	398	398	265	227	199	159	133	114	99	88	80
20	637	424	318	318	212	182	159	127	106	91	80	71	64
15	477	318	239	239	159	136	119	95	80	68	60	53	48
10	318	212	159	159	106	91	80	64	53	45	40	35	32
	10	15	20	25	30	35	40	50	60	70	80	90	100

SELECCIÓN DE DIÁMETRO (Ø mm)