

BLUE-MASTER[®]
by *celesa*



ANNULAR
CUTTERS

ANNULAR CUTTERS FOR ELECTROMAGNETIC DRILLING MACHINES

Holesaws

Pink

HSS



Ref. 250R

**30 mm
CUTTING
CAPACITY**
HSS

Ref. 500R

**50 mm
CUTTING
CAPACITY**
AVAILABLE FOR MACHINE TYPES AS BELOW:

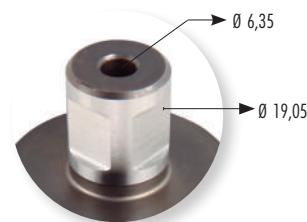
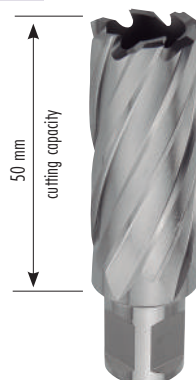
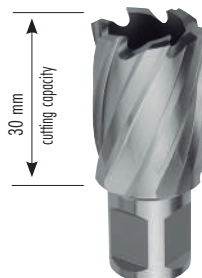
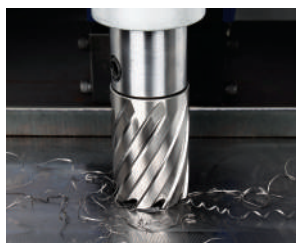
Rota Broach - Alfa Rota Best - Magnetor - Slugger - Dr. Bemder - Bux - Hougen

250R

	Ø mm	€
250R12	12	25,63
250R13	13	25,99
250R14	14	26,21
250R15	15	26,14
250R16	16	26,40
250R17	17	28,05
250R18	18	28,13
250R19	19	28,18
250R20	20	29,40
250R21	21	31,37
250R22	22	32,53
250R23	23	33,32
250R24	24	34,63
250R25	25	35,76
250R26	26	37,04
250R27	27	39,75
250R28	28	40,92
250R29	29	43,57
250R30	30	43,43
250R31	31	47,29
250R32	32	47,51
250R33	33	54,96
250R34	34	58,38
250R35	35	58,75
250R36	36	62,35
250R37	37	63,48
250R38	38	64,11
250R39	39	64,69
250R40	40	68,73
250R41	41	69,97
250R42	42	74,62
250R43	43	80,61
250R44	44	83,17
250R45	45	84,12
250R46	46	86,05
250R47	47	87,65
250R48	48	91,17
250R49	49	91,82
250R50	50	97,25

500R

	Ø mm	€
500R12	12	38,07
500R13	13	38,07
500R14	14	34,22
500R15	15	36,67
500R16	16	38,59
500R17	17	38,82
500R18	18	39,19
500R19	19	40,00
500R20	20	41,77
500R21	21	42,79
500R22	22	44,00
500R23	23	47,06
500R24	24	48,45
500R25	25	61,20
500R26	26	63,90
500R27	27	67,82
500R28	28	70,96
500R29	29	75,52
500R30	30	76,80
500R31	31	82,72
500R32	32	84,21
500R33	33	90,31
500R34	34	94,31
500R35	35	95,91
500R36	36	101,09
500R37	37	103,62
500R38	38	105,26
500R39	39	113,05
500R40	40	115,92
500R41	41	123,88
500R42	42	126,99
500R43	43	128,67
500R44	44	130,26
500R45	45	135,89
500R46	46	135,86
500R47	47	148,70
500R48	48	152,42
500R49	49	151,44
500R50	50	154,73

SCREW HOLE PUNCH BODY Ø 6,35 mm

	DESCRIPTION	L mm	€
P250CA	Standard pin for cutters 250R/C/T series	71	12,38
P250CAA	For using with adaptors to FEIN/NITTO 250R/C/T	101	15,75
P500CA	Standard pin for cutters 500R/C/Tseries	92	14,25

ANNULAR CUTTERS FOR ELECTROMAGNETIC DRILLING MACHINES

HSSCo
8%

110
Kg/mm²

Ref. 250C

30 mm
CUTTING CAPACITY

AVAILABLE FOR MACHINE TYPES AS BELOW:
Rota Broach - Alfa Rota Best - Magnetor - Slugger - Dr. Bemder - Bux - Hougen

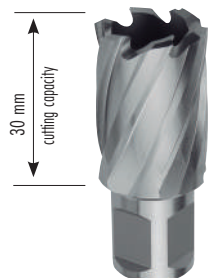

250C		
	Ø mm	€
250C12	12	44,50
250C13	13	44,50
250C14	14	44,50
250C15	15	47,84
250C16	16	51,26
250C17	17	51,29
250C18	18	53,65
250C19	19	59,83
250C20	20	63,68
250C21	21	69,69
250C22	22	71,69
250C23	23	75,38
250C24	24	78,07
250C25	25	81,41
250C26	26	83,75
250C27	27	86,43
250C28	28	89,46
250C29	29	91,22
250C30	30	91,63
250C31	31	99,77
250C32	32	101,29
250C33	33	103,31
250C34	34	105,72
250C35	35	112,84
250C36	36	113,34
250C37	37	114,42
250C38	38	120,47
250C39	39	120,64
250C40	40	125,79
250C41	41	175,33
250C42	42	180,09
250C43	43	187,85
250C44	44	193,81
250C45	45	200,95
250C46	46	207,53
250C47	47	213,49
250C48	48	218,27
250C49	49	247,58
250C50	50	225,43
250C51	51	235,19
250C52	52	242,10
250C53	53	250,75
250C54	54	273,23
250C55	55	295,71
250C56	56	296,10

HSSCo
8%

110
Kg/mm²

Ref. 500C

50 mm
CUTTING CAPACITY

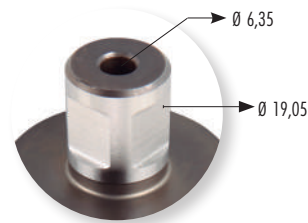
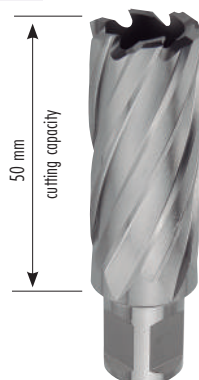

500C		
	Ø mm	€
500C12	12	61,27
500C13	13	57,80
500C14	14	57,80
500C15	15	63,23
500C16	16	72,36
500C17	17	72,91
500C18	18	80,19
500C19	19	88,79
500C20	20	94,24
500C21	21	104,18
500C22	22	106,53
500C23	23	110,21
500C24	24	112,57
500C25	25	117,25
500C26	26	122,10
500C27	27	126,96
500C28	28	123,44
500C29	29	128,12
500C30	30	131,88
500C31	31	138,83
500C32	32	139,39
500C33	33	141,72
500C34	34	143,31
500C35	35	146,10
500C36	36	147,55
500C37	37	152,78
500C38	38	153,88
500C39	39	156,51
500C40	40	161,54
500C41	41	193,19
500C42	42	199,77
500C43	43	206,93
500C44	44	214,08
500C45	45	219,45
500C46	46	227,20
500C47	47	232,57
500C48	48	239,73
500C49	49	304,20
500C50	50	304,90
500C51	51	314,73
500C52	52	319,92
500C53	53	323,57
500C54	54	328,78
500C55	55	330,41
500C56	56	339,33

500C		
	Ø mm	€
500C57	57	362,64
500C58	58	400,09
500C59	59	412,43
500C60	60	422,91
500C61	61	432,76
500C62	62	438,80
500C63	63	455,59
500C64	64	463,10
500C65	65	475,36
500C66	66	584,60
500C67	67	602,55
500C68	68	611,22
500C69	69	619,96
500C70	70	629,06
500C71	71	660,28
500C72	72	664,03
500C73	73	668,33
500C74	74	679,20
500C75	75	668,21
500C76	76	709,66
500C77	77	715,47
500C78	78	723,24
500C79	79	729,61
500C80	80	731,45
500C81	81	741,69
500C82	82	749,01
500C83	83	760,34
500C84	84	769,05
500C85	85	771,09
500C86	86	795,48
500C87	87	807,19
500C88	88	811,04
500C89	89	814,97
500C90	90	822,74
500C91	91	830,81
500C92	92	842,24
500C93	93	849,26
500C94	94	859,75
500C95	95	871,74
500C96	96	878,97
500C97	97	887,96
500C98	98	898,07
500C99	99	919,15
500C100	100	928,80

SCREW HOLE PUNCH BODY Ø 6,35 mm



	DESCRIPTION	L mm	€
P250CA	Standard pin for cutters 250R/C/T series	71	12,38
P250CAA	For using with adaptors to FEIN/NITTO 250R/C/T	101	15,75
P500CA	Standard pin for cutters 500R/C/T series	92	14,25

ANNULAR CUTTERS FOR ELECTROMAGNETIC DRILLING MACHINES
HSSCo
8%

110
 Kg/mm²
TiAlN

Ref. 250T

30 mm
CUTTING
CAPACITY
HSSCo
8%

110
 Kg/mm²
TiAlN

Ref. 500T

50 mm
CUTTING
CAPACITY

AVAILABLE FOR MACHINE TYPES AS BELOW:

Rota Broach - Alfa Rota Best - Magnetor - Slugger - Dr. Bemder - Bux - Hougen

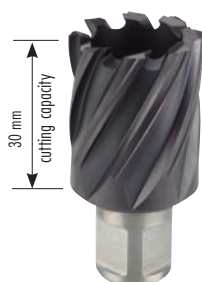
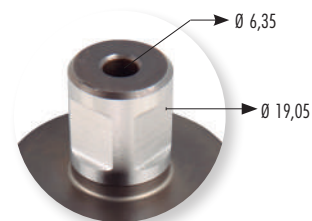

250T		
	Ø mm	€
250T12	12	57,62
250T13	13	57,62
250T14	14	57,62
250T15	15	62,96
250T16	16	66,68
250T17	17	69,46
250T18	18	72,86
250T19	19	80,24
250T20	20	84,29
250T21	21	94,09
250T22	22	98,16
250T23	23	101,69
250T24	24	105,39
250T25	25	109,46
250T26	26	113,55
250T27	27	117,44
250T28	28	121,14
250T29	29	123,79
250T30	30	124,70
250T31	31	136,20
250T32	32	138,38
250T33	33	142,43
250T34	34	152,87
250T35	35	153,02

250T		
	Ø mm	€
250T36	36	153,43
250T37	37	156,04
250T38	38	163,25
250T39	39	163,72
250T40	40	165,72
250T41	41	227,07
250T42	42	237,75
250T43	43	246,66
250T44	44	253,52
250T45	45	261,75
250T46	46	269,31
250T47	47	276,15
250T48	48	281,65
250T49	49	288,99
250T50	50	289,88
250T51	51	301,11
250T52	52	309,06
250T53	53	319,01
250T54	54	344,86
250T55	55	375,52
250T56	56	403,35
250T57	57	429,20
250T58	58	469,70
250T59	59	483,05
250T60	60	486,48

500T		
	Ø mm	€
500T12	12	76,95
500T13	13	76,95
500T14	14	76,95
500T15	15	87,70
500T16	16	99,36
500T17	17	99,59
500T18	18	108,23
500T19	19	119,83
500T20	20	127,31
500T21	21	142,44
500T22	22	147,06
500T23	23	152,07
500T24	24	156,89
500T25	25	161,90
500T26	26	166,50
500T27	27	174,11
500T28	28	181,69
500T29	29	188,87
500T30	30	192,24
500T31	31	193,70
500T32	32	194,27
500T33	33	194,87
500T34	34	195,74
500T35	35	196,79

500T		
	Ø mm	€
500T36	36	198,08
500T37	37	199,39
500T38	38	199,74
500T39	39	202,07
500T40	40	202,53
500T41	41	290,04
500T42	42	297,59
500T43	43	308,23
500T44	44	317,56
500T45	45	326,15
500T46	46	336,53
500T47	47	345,09
500T48	48	353,36
500T49	49	430,32
500T50	50	365,10
500T51	51	444,85
500T52	52	450,50
500T53	53	459,68
500T54	54	471,01
500T55	55	480,23
500T56	56	507,38
500T57	57	552,45
500T58	58	601,61
500T59	59	618,70
500T60	60	633,38

SCREW HOLE PUNCH BODY Ø 6,35 mm

	DESCRIPTION	L mm	€
P250CA	Standard pin for cutters 250R/C/T series	71	12,38
P250CAA	For using with adaptors to FEIN/NITTO 250R/C/T	101	15,75
P500CA	Standard pin for cutters 500R/C/T series	92	14,25

ANNULAR CUTTERS FOR ELECTROMAGNETIC DRILLING MACHINES

HSSCo
8%

110
Kg/mm²

Ref. 750C

75 mm
CUTTING
CAPACITY

Ref. 1000C

100 mm
CUTTING
CAPACITY

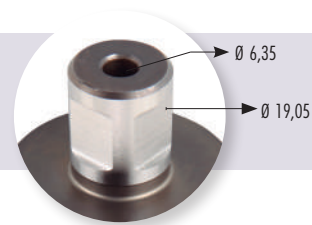

AVAILABLE FOR MACHINE TYPES AS BELOW:
Rota Broach - Alfa Rota Best - Magnetor - Slugger - Dr. Bemder - Bux - Hougen



750C		
	Ø mm	€
750C50	50	413,39
750C51	51	431,24
750C52	52	435,22
750C53	53	439,10
750C54	54	444,41
750C55	55	451,47
750C56	56	460,01
750C57	57	464,44
750C58	58	475,00
750C59	59	486,36
750C60	60	510,89
750C61	61	531,09
750C62	62	546,34
750C63	63	556,71
750C64	64	570,96
750C65	65	585,22
750C66	66	731,15
750C67	67	748,20
750C68	68	764,09
750C69	69	776,43
750C70	70	786,53
750C71	71	797,71
750C72	72	810,77
750C73	73	823,12
750C74	74	834,03
750C75	75	843,37
750C76	76	853,23
750C77	77	860,87
750C78	78	869,52
750C79	79	887,37
750C80	80	911,37
750C81	81	938,54
750C82	82	947,92
750C83	83	975,86
750C84	84	996,86
750C85	85	1.021,52
750C86	86	1.052,10
750C87	87	1.082,55
750C88	88	1.100,50
750C89	89	1.126,63
750C90	90	1.151,23
750C91	91	1.189,71
750C92	92	1.224,40
750C93	93	1.250,45
750C94	94	1.289,37
750C95	95	1.326,05
750C96	96	1.346,96
750C97	97	1.374,98
750C98	98	1.402,19
750C99	99	1.425,08
750C100	100	1.449,87



1000C		
	Ø mm	€
1000C50	50	526,38
1000C51	51	532,79
1000C52	52	535,54
1000C53	53	537,70
1000C54	54	540,95
1000C55	55	546,75
1000C56	56	552,83
1000C57	57	556,84
1000C58	58	570,55
1000C59	59	583,12
1000C60	60	607,41
1000C61	61	618,14
1000C62	62	634,86
1000C63	63	645,17
1000C64	64	662,22
1000C65	65	672,37
1000C66	66	779,01
1000C67	67	795,57
1000C68	68	810,38
1000C69	69	827,68
1000C70	70	834,16
1000C71	71	850,30
1000C72	72	862,45
1000C73	73	873,77
1000C74	74	883,58
1000C75	75	894,14
1000C76	76	905,72
1000C77	77	910,28
1000C78	78	914,94
1000C79	79	934,66
1000C80	80	1.052,46
1000C81	81	1.076,89
1000C82	82	1.095,74
1000C83	83	1.117,52
1000C84	84	1.143,78
1000C85	85	1.170,14
1000C86	86	1.215,34
1000C87	87	1.242,13
1000C88	88	1.268,85
1000C89	89	1.292,83
1000C90	90	1.327,44
1000C91	91	1.368,06
1000C92	92	1.404,92
1000C93	93	1.437,22
1000C94	94	1.485,81
1000C95	95	1.521,50
1000C96	96	1.547,02
1000C97	97	1.577,67
1000C98	98	1.605,31
1000C99	99	1.630,94
1000C100	100	1.670,55

SCREW HOLE PUNCH BODY Ø 6,35 mm



	DESCRIPTION	L mm	€
P750CA	Standard pin for cutters 750C series	123	17,39
P1000CA	Standard pin for cutters 1000C series	147	20,51
P1000CAA	For using with adaptors to FEIN/NITTO 1000C	177	17,18

ANNULAR CUTTERS FOR ELECTROMAGNETIC DRILLING MACHINES
HSS

Ref. 1500C

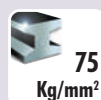
150 mm
CUTTING
CAPACITY
HSS

Ref. 2000C

200 mm
CUTTING
CAPACITY

1500C

	Ø mm	€
1500C22	22	516,10
1500C24	24	555,97
1500C26	26	564,19
1500C28	28	596,88
1500C30	30	651,28
1500C32	32	741,25
1500C34	34	803,62
1500C36	36	839,51
1500C38	38	888,78
1500C40	40	938,71
1500C42	42	1.047,56
1500C44	44	1.156,66
1500C46	46	1.255,83
1500C48	48	1.386,08
1500C50	50	1.456,27
1500C52	52	1.714,42
1500C54	54	1.835,94
1500C55	55	2.017,10

2000C

	Ø mm	€
2000C26	26	784,22
2000C28	28	829,67
2000C30	30	905,29
2000C32	32	1.030,34
2000C34	34	1.117,02
2000C36	36	1.247,27
2000C38	38	1.320,44
2000C40	40	1.394,63
2000C42	42	1.556,34
2000C44	44	1.718,41
2000C46	46	1.865,76
2000C48	48	2.111,55
2000C50	50	2.218,48
2000C52	52	2.413,02
2000C54	54	2.487,25

SCREW HOLE PUNCH BODY Ø 8 mm

	DESCRIPTION	L mm	€
P1500CA	Standard pin for cutters 1500 series	220	34,73
P2000CA	Standard pin for cutters 2000 series	248	43,99
P2500CA	Extra Long pin for use with annular cutters with extensions	310	76,35

CARBIDE TIPPED CUTTERS FOR ELECTROMAGNETIC DRILLING MACHINES

**35 mm
CUTTING
CAPACITY**

**50 mm
CUTTING
CAPACITY**

**CARBIDE
TIPPED**



INOX

Al



**CAST
IRON**

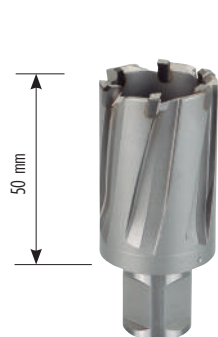

Ref. 350A

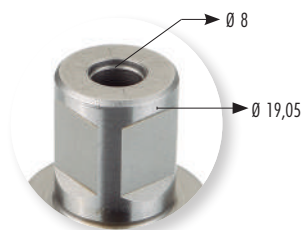

DOUBLE WELDON
SHANK

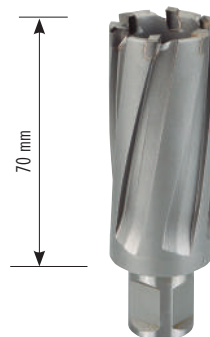

Ref. 500A

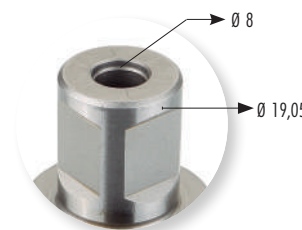

DOUBLE WELDON
SHANK

35 mm CAPACITY

350A		
	Ø mm	€
350A12	12,0	96,78
350A13	13,0	96,78
350A14	14,0	96,78
350A15	15,0	96,78
350A16	16,0	96,78
350A17	17,0	96,78
350A17,5*	17,5	62,73
350A18	18,0	96,78
350A19	19,0	96,78
350A20	20,0	96,78
350A21	21,0	96,78
350A21,5*	21,5	67,31
350A22	22,0	103,85
350A22,5*	22,5	67,31
350A23	23,0	103,85
350A23,5*	23,5	67,31
350A24	24,0	103,85
350A24,5*	24,5	67,31
350A25	25,0	103,85

350A		
	Ø mm	€
350A26	26,0	103,85
350A26,5*	26,5	67,31
350A27	27,0	103,85
350A28	28,0	103,85
350A29	29,0	103,85
350A30	30,0	103,85
350A31	31,0	115,66
350A32	32,0	115,66
350A33	33,0	115,66
350A34	34,0	115,66
350A35	35,0	115,66
350A36	36,0	115,66
350A37	37,0	115,66
350A38	38,0	115,66
350A39	39,0	140,45
350A40	40,0	140,45
350A41	41,0	140,45
350A42	42,0	140,45
350A43	43,0	140,45
350A44	44,0	140,45
350A45	45,0	140,45
350A46	46,0	165,81
350A47	47,0	165,81
350A48	48,0	165,81
350A49	49,0	165,81
350A50	50,0	165,81
350A51	51,0	185,32
350A52	52,0	185,32

50 mm CUTTING CAPACITY

500A		
	Ø mm	€
500A14	14,0	113,27
500A15	15,0	113,27
500A16	16,0	113,27
500A17	17,0	113,27
500A17,5*	17,5	73,42
500A18	18,0	113,27
500A19	19,0	113,27
500A20	20,0	113,27
500A21	21,0	113,27
500A21,5*	21,5	78,55
500A22	22,0	121,19
500A22,5*	22,5	78,55
500A23	23,0	121,19
500A23,5*	23,5	78,55
500A24	24,0	121,19
500A24,5*	24,5	78,55
500A25	25,0	121,19
500A26	26,0	121,19
500A26,5*	26,5	78,55
500A27	27,0	121,19
500A28	28,0	121,19
500A29	29,0	121,19
500A30	30,0	121,19
500A31	31,0	134,36
500A32	32,0	134,36
500A33	33,0	134,36
500A34	34,0	134,36
500A35	35,0	134,36
500A36	36,0	154,10
500A37	37,0	154,10
500A38	38,0	154,10
500A39	39,0	154,10

500A		
	Ø mm	€
500A40	40,0	154,10
500A41	41,0	180,45
500A42	42,0	180,45
500A43	43,0	180,45
500A44	44,0	180,45
500A45	45,0	180,45
500A46	46,0	200,21
500A47	47,0	200,21
500A48	48,0	200,21
500A49	49,0	200,21
500A50	50,0	200,21
500A51	51,0	221,27
500A52	52,0	221,27
500A53	53,0	221,27
500A54	54,0	221,27
500A55	55,0	221,27
500A56	56,0	283,63
500A57	57,0	283,63
500A58	58,0	283,63
500A59	59,0	283,63
500A60	60,0	283,63
500A61	61,0	328,41
500A62	62,0	328,41
500A63	63,0	328,41
500A64	64,0	328,41
500A65	65,0	328,41
500A66	66,0	348,30
500A67	67,0	348,30
500A68	68,0	348,30
500A69	69,0	348,30
500A70	70,0	348,30

Shank 32 mm

*Until end of stock



- The hit between cutter and material must be soft, without crashings or hard pushings.
- Use CUT MAGIC cutting fluid.

PILOT PINS FOR CARBIDE TIPPED CUTTERS



Ref. P350AA



Ref. P350AA-1

	DESCRIPTION	Ø x L mm	€
P350AA	350A Ø 12 - 15 mm cutters	Ø 5 x 91	19,80
P350AA-1	350A Ø 16 - 52 mm cutters	Ø 8 x 91	20,26
P500A	500A Ø 14 - 16 mm cutters	Ø 5 x 112	21,61
P500AA	500A Ø 17 - 70 mm cutters	Ø 8 x 112	22,73

CARBIDE TIPPED CUTTERS FOR ELECTROMAGNETIC DRILLING MACHINES
75 mm
 CUTTING
 CAPACITY

100 mm
 CUTTING
 CAPACITY

CARBIDE
 TIPPED

INOX
Al

Cu - Ni - La

CAST
IRON

Ref. 750A

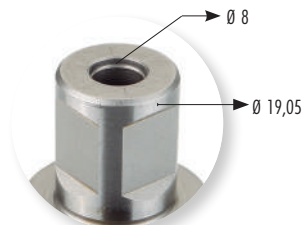
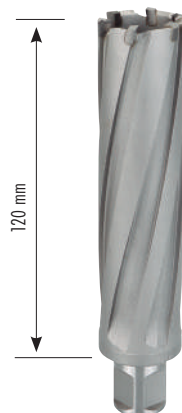
 DOUBLE WELDON
 SHANK

Ref. 1000A

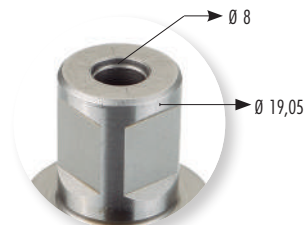
 DOUBLE WELDON
 SHANK

75 mm CAPACITY

	750A		750A		
	Ø mm	€	Ø mm		
750A17	17	173,69	750A52	52	384,52
750A18	18	173,69	750A53	53	384,52
750A19	19	173,69	750A54	54	384,52
750A20	20	173,69	750A55	55	384,52
750A21	21	173,69	750A56	56	434,89
750A22	22	185,81	750A57	57	434,89
750A23	23	185,81	750A58	58	434,89
750A24	24	185,81	750A59	59	434,89
750A25	25	185,81	750A60	60	434,89
750A26	26	185,81	750A61	61	503,55
750A27	27	185,81	750A62	62	503,55
750A28	28	185,81	750A63	63	503,55
750A29	29	185,81	750A64	64	503,55
750A30	30	185,81	750A65	65	503,55
750A31	31	206,02	750A66	66	503,55
750A32	32	206,02	750A67	67	503,55
750A33	33	206,02	750A68	68	503,55
750A34	34	206,02	750A69	69	503,55
750A35	35	206,02	750A70	70	503,55
750A36	36	236,29	750A75	75	623,21
750A37	37	236,29	750A80	80	658,52
750A38	38	236,29	750A85	85	714,41
750A39	39	236,29	750A90	90	784,59
750A40	40	236,29	750A95	95	819,47
750A41	41	276,70	750A100	100	896,37
750A42	42	276,70	750A105	105	1.232,56
750A43	43	276,70	750A110	110	1.576,36
750A44	44	276,70	750A115	115	1.589,76
750A45	45	276,70	750A120	120	1.589,76
750A46	46	319,26	750A125	125	2.045,30
750A47	47	319,26	750A130	130	2.119,79
750A48	48	319,26	750A135	135	2.231,11
750A49	49	319,26	750A140	140	2.231,11
750A50	50	347,91	750A145	145	2.824,38
750A51	51	384,52	750A150	150	2.824,38

Shank 32 mm

100 mm CUTTING CAPACITY

	1000A		1000A		
	Ø mm	€	Ø mm		
1000A18	18	195,94	1000A51	51	486,43
1000A19	19	195,94	1000A52	52	486,43
1000A20	20	195,94	1000A53	53	486,43
1000A21	21	195,94	1000A54	54	486,43
1000A22	22	201,41	1000A55	55	486,43
1000A23	23	201,41	1000A56	56	550,12
1000A24	24	201,41	1000A57	57	550,12
1000A25	25	213,68	1000A58	58	550,12
1000A26	26	213,68	1000A59	59	550,12
1000A27	27	213,68	1000A60	60	550,12
1000A28	28	213,68	1000A61	61	636,99
1000A29	29	213,68	1000A62	62	636,99
1000A30	30	213,68	1000A63	63	636,99
1000A31	31	236,92	1000A64	64	636,99
1000A32	32	236,92	1000A65	65	636,99
1000A33	33	236,92	1000A66	66	636,99
1000A34	34	236,92	1000A67	67	777,54
1000A35	35	236,92	1000A68	68	777,54
1000A36	36	271,73	1000A69	69	777,54
1000A37	37	271,73	1000A70	70	777,54
1000A38	38	271,73	1000A75	75	777,54
1000A39	39	271,73	1000A80	80	797,22
1000A40	40	271,73	1000A85	85	902,16
1000A41	41	318,20	1000A90	90	945,54
1000A42	42	318,20	1000A95	95	988,92
1000A43	43	350,03	1000A100	100	1.044,54
1000A44	44	350,03	1000A105	105	1.470,96
1000A45	45	350,03	1000A110	110	1.470,96
1000A46	46	388,34	1000A115	115	1.965,24
1000A47	47	388,34	1000A120	120	1.965,24
1000A48	48	388,34	1000A125	125	2.519,59
1000A49	49	388,34	1000A130	130	2.519,59
1000A50	50	460,12	1000A135	135	3.151,80
			1000A140	140	3.151,80
			1000A145	145	4.233,43
			1000A150	150	4.233,43

Shank 32 mm

PILOT PINS FOR CARBIDE TIPPED CUTTERS

	DESCRIPTION	Ø x L mm	€
P750AA	750A Ø 17 - 70 mm cutters	Ø8x140	33,00
P750AA-1	750A Ø 75 - 150 mm cutters	Ø8x160	37,95
P1000AA	1000A Ø 25 - 70 mm cutters	Ø8x160	44,73
P1000AA-1	1000A Ø 75 - 150 mm cutters	Ø8x190	51,42

**ANNULAR CUTTER FOR ELECTROMAGNETIC DRILLING MACHINES WITH DOUBLE WELDON Ø 19,05 mm
SPECIAL FOR RAILROADS, HARDOX ...**



- Solid carbide teeth.
- For extremely hard materials.
- Possibility to work in lathes and drilling and milling machines.
- Possibility to work with quick change Morse taper



Holesaws

Pink

Ref. MB250AT
Ref. MB500AT

HSSCo
8%

TiAlN

HARDOX
450

HARDOX
500

Ref. MB350ST
Ref. MB500ST

CARBIDE
TIPPED

HARDOX
450

HARDOX
500

HARDOX
600

25 mm
CUTTING
CAPACITY



Ref. MB250AT

25 mm CAPACITY

50 mm
CUTTING
CAPACITY



Ref. MB500AT

50 mm CAPACITY

35 mm
CUTTING
CAPACITY

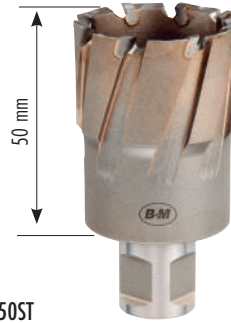

Ref. MB350ST

35 mm CAPACITY

50 mm
CUTTING
CAPACITY

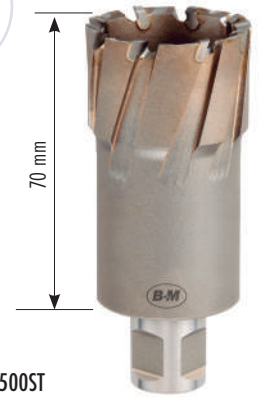

Ref. MB500ST

50 mm CAPACITY

MB250AT		
	Ø mm	€
MB250AT16	16	143,95
MB250AT18	18	148,09
MB250AT20	20	152,23
MB250AT22	22	159,02
MB250AT24	24	164,71
MB250AT26	26	170,00
MB250AT28	28	175,47
MB250AT30	30	181,01
MB250AT32	32	212,53

MB500AT		
	Ø mm	€
MB500AT16	16	179,60
MB500AT18	18	189,21
MB500AT20	20	198,80
MB500AT22	22	207,07
MB500AT24	24	213,85
MB500AT26	26	220,71
MB500AT28	28	231,72
MB500AT30	30	245,39
MB500AT32	32	270,73

MB350ST		
	Ø mm	€
MB350ST18	18	154,94
MB350ST19	19	154,94
MB350ST20	20	154,94
MB350ST21	21	154,94
MB350ST22	22	166,26
MB350ST23	23	166,26
MB350ST24	24	166,26
MB350ST25	25	166,26
MB350ST26	26	166,26
MB350ST27	27	166,26
MB350ST28	28	166,26
MB350ST29	29	166,26
MB350ST30	30	166,26
MB350ST31	31	185,17
MB350ST32	32	185,17
MB350ST33	33	185,17
MB350ST34	34	185,17
MB350ST35	35	185,17
MB350ST36	36	185,17

MB500ST		
	Ø mm	€
MB500ST37	37	217,32
MB500ST38	38	217,32
MB500ST39	39	217,32
MB500ST40	40	217,32
MB500ST41	41	233,85
MB500ST42	42	233,85
MB500ST43	43	233,85
MB500ST44	44	233,85
MB500ST45	45	233,85
MB500ST46	46	272,94
MB500ST47	47	272,94
MB500ST48	48	272,94
MB500ST49	49	272,94
MB500ST50	50	272,94

**Ø 6,35 mm PILOT PINS Ref. MB250AT
and Ref. MB500AT ANNULAR CUTTERS**



**PILOT PINS
Ref. MB350ST & MB500ST ANNULAR CUTTERS**



	DESCRIPTION	L mm	€
P250CA	Ref. MB250AT Ø 16-32 mm cutters	71	12,38
P500CA	Ref. MB500AT Ø 16-32 mm cutters	92	14,25

	DESCRIPTION	Ø x L mm	€
P350AA-1	Ref. MB350ST Ø18-36 mm	Ø8x91	20,26
P500AA	Ref. MB500ST Ø37-50 mm	Ø8x112	22,73

DRILLS, TAPS AND ACCESSORIES FOR ELECTROMAGNETIC DRILLING MACHINES

Holesaws

Pink

HSS

DRILL BIT

Ref. BMG

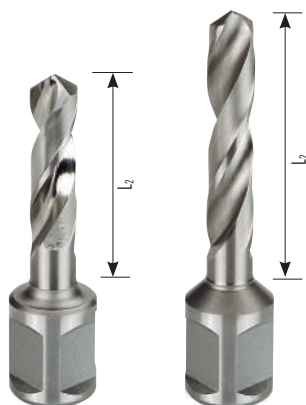
HSS

DRILL TAP

Ref. MBE

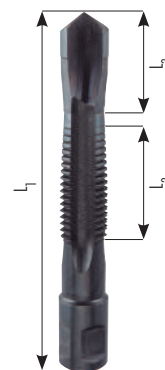

	Ø mm	L ₂ mm	BMG		BMGL	
			€	L ₂ mm	€	
BMG0600	6,00	25	35,88	50	52,64	
BMG0675	6,75	25	42,22	50		
BMG0700	7,00	25	42,22	50	52,75	
BMG0800	8,00	25	42,22	50	52,75	
BMG0850	8,50	25	42,22	50		
BMG0900	9,00	25	42,22	50	52,75	
BMG1000	10,00	25	44,48	50	55,59	
BMG1020	10,20	25	44,48	50		
BMG1100	11,00	25	44,48	50	55,59	
BMG1200	12,00	25	44,48	50	55,59	
BMG1300	13,00	25	47,62	50	63,33	
BMG1400	14,00	25	48,52	50	64,52	
BMG1500	15,00	25	48,98	50	66,11	
BMG1600	16,00	25	60,43	50	75,54	

	Ø	L ₁ x L ₂ x L ₃ mm	THREAD	MBE
				€
MBE8M08X1,25	6,75	110x12,5x15	M8 x 1,25	83,06
MBE8M10X1,50	8,50	113x15,0x15	M10 x 1,50	83,06
MBE8M12X1,75	10,20	117x18,0x16	M12 x 1,75	83,06
MBE8M14X2,00	12,00	117x20,0x16	M14 x 2,00	83,06
MBE8M16X2,00	14,00	117x20,0x16	M16 x 2,00	83,06
MBE8M18X2,50	15,50	130x25,0x16	M18 x 2,50	83,06
MBE8M20X2,50	17,50	135x25,0x16	M20 x 2,50	92,37
MBE8M22X2,50	19,50	135x25,0x17	M22 x 2,50	98,74
MBE8M24X3,00	21,00	148x30,0x17	M24 x 3,00	131,86
MBE8M27X3,00	24,00	155x30,0x18	M27 x 3,00	168,46
MBE8M30X3,50	26,50	169x63,0x19	M30 x 3,50	191,69

HSS

COUNTERSINK

Ref. ABE

90°



	Ø mm	ABE
		€
ABE25	25	92,10
ABE30	30	102,96
ABE40	40	120,57
ABE50	50	168,05
ABE55	55	184,23
ABE63	63	248,46



DRILLS, TAPS AND ACCESSORIES FOR ELECTROMAGNETIC DRILLING MACHINES

Holesaws

Pink

HSS

COUNTERSINK

Ref. MBE

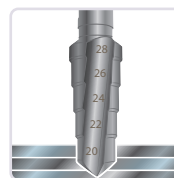

Several dimensions in one tool

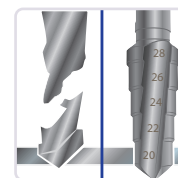

More rigid than holesaws

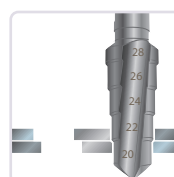

Able to drill two separated pieces. Can align two non-coaxial holes.

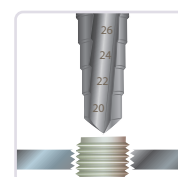

Able to enlarge holes.

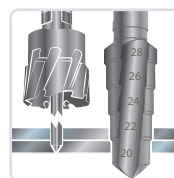

Can drill through different sheets without breaking problem as in the hole-saws.



No need for pilot pin.

MBE

	Ø Z mm min - max	Geometry	Z	Lz mm	€
MBE08-16	8 - 10 - 12 - 14 - 16	Type A	5	12	43,93
MBE10-18	10 - 12 - 14 - 16 - 18	Type A	5	12	48,64
MBE20-28	20 - 22 - 24 - 26 - 28	Type A	5	12	69,30
MBE30-38	30 - 32 - 34 - 36 - 38	Type B	5	12	107,89
MBE40-48	40 - 42 - 44 - 46 - 48	Type B	5	12	154,55
MBE10-14	10 - 12 - 14	Type A	3	25	37,35
MBE16-20	16 - 18 - 20	Type A	3	25	53,29
MBE22-26	22 - 24 - 26	Type B	3	25	63,97
MBE28-32	28 - 30 - 32	Type B	3	25	86,61
MBE34-38	34 - 36 - 38	Type B	3	25	107,92
MBE40-44	40 - 42 - 44	Type B	3	25	133,22
MBE46-50	46 - 48 - 50	Type B	3	25	159,88

Type A geometry: With tip and centre cutting.

Type B Geometry: Without tip and without centre cutting. Only enlarges holes already drilled.

HSS

Ref. MBE



Ref. MBEHEX1/4

MBEHEX1/4

	DESCRIPTION	€
MBEHEX1/4	DOUBLE WELDON 19,05 a 1/4" HEX	16,38

EXTENSIONS FOR ELECTROMAGNETIC DRILLING MACHINES

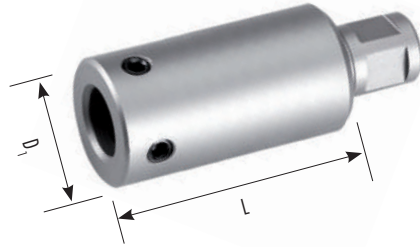
SHANK: 19,05 mm DOUBLE WELDON
EXIT: 19,05 mm WELDON

ACRWX			
	L mm	D1 mm	€
ACRWX75	75	35	40,99
ACRWX100	100	35	91,00
ACRWX150	150	35	120,12
ACRWX200	200	35	162,59
ACRWX250	250	35	202,64

This adaptor is provided with an extension pilot pin which enables to use the HSS/HSSCo annular cutters with the original pilot pin, it is not necessary to replace it with an extra-large one. In the case of carbide teeth Annular Cutters, it becomes necessary to replace the pilot pin with a larger one as P1500CA, P2000CA o P2500CA.

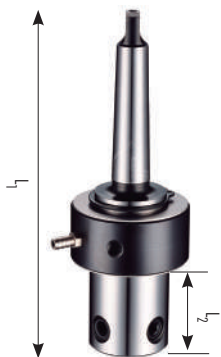
EXTENSIONS FOR ELECTROMAGNETIC DRILLING MACHINES

Ref. CMN°2



Ref. CMN°2SR



Ref. CMN°2CR



Ref. CMN°3



Ref. CMN°3SR



Ref. CMN°3x32



Ref. CMN°4x32



	L2 mm	L1 mm	CM	Exit	Cooling	€
CMN°2	43	158	2	19,05	Yes	177,07
CMN°2SR	43	158	2	19,05	No	141,66
CMN°2CR	43	158	2	19,05 Quick Change	Yes	289,54
CMN°3	43	177	3	19,05	Yes	189,71
CMN°3SR	43	177	3	19,05	No	151,77
CMN°3CR	43	177	3	19,05 Quick Change	Yes	289,54
CMN°4	80	250	4	19,05	Yes	240,12
CMN°5	80	270	5	19,05	Yes	251,66
CMN°3x32	116	229	3	32,00	Yes	242,13
CMN°4x32	116	250	4	32,00	Yes	314,44

CONVERTERS FOR OTHER SHANK TYPES



ACR18W

**SHANK: 18 mm FEIN
EXIT: 19,05 mm DOUBLE WELDON**



ACRWB16

**SHANK: NITTO
EXIT: 19,05 mm DOUBLE WELDON**



ACR18W
40,99 €

**SHANK: 19,05 mm DOUBLE WELDON
EXIT: M18 X 6 P1,5 THREAD**



ACR18W
40,99 €

**SHANK: 19,05 mm DOUBLE WELDON
EXIT: B16**



ACRWB16
40,99 €

**SHANK: NITTO
EXIT: M18 X 6 P1,5 THREAD**



ACRWB16
40,99 €

**SHANK: 18 mm FEIN
EXIT: B16**



ACRNM18X6P1,5
40,99 €

**SHANK: 19,05 mm DOUBLE WELDON
EXIT: 1/2 X 20 UNF**



ACR18B16
40,99 €

**SHANK: NITTO / 19,05 mm DOUBLE WELDON
EXIT: B16**



ACRW1/2X20
40,99 €

**SHANK: NITTO / 19,05 mm DOUBLE WELDON
EXIT: 1/2 X 20 UNF**



ACRNB16
40,99 €

**SHANK: 19,05 mm DOUBLE WELDON
EXIT: 32 mm DOUBLE WELDON**



ACRN1/2X20
40,99 €

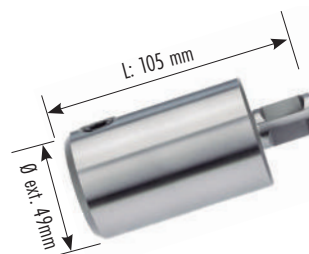

ACRWX32
40,99 €

ANNULAR CUTTERS FOR ELECTROMAGNETIC DRILLING MACHINES. CASES AND METHACRYLATE DISPLAYS

Holesaws

Pink



	Content:		€
NEW			
EFB250R1	6 Ref. 250R cutters: Ø 12 - 14 - 16 - 18 - 20 - 22 mm 2 Pilot pins Ref. P250CA	HSS	196,06
EFB250C1	6 Ref. 250C cutters: Ø 12 - 14 - 16 - 18 - 20 - 22 mm 2 Pilot pins Ref. P250CA	HSSCo	357,03
EFB500R1	6 Ref. 500R cutters: Ø 12 - 14 - 16 - 18 - 20 - 22 mm 2 Pilot pins Ref. P500CA	HSS	267,33
EFB500C1	6 Ref. 500C cutters: Ø 12 - 14 - 16 - 18 - 20 - 22 mm 2 Pilot pins Ref. P500CA	HSSCo	503,88
EFB500R5	6 Ref. 500R cutters: Ø 14 - 16 - 18 - 20 - 22 - 24 mm 2 Pilot pins Ref. P500CA	HSS	277,71
EFB500C5	6 Ref. 500C: Ø 14 - 16 - 18 - 20 - 22 - 24 mm 2 Pilot pins Ref. P500CA	HSSCo	555,18

	Content:		€
NEW			
EFBBMG1	6 Ref. BMG: Ø 6 - 8 - 10 - 12 - 14 - 16 mm	HSS	279,00

EFBBMG2	3 Ref. BMG: Ø 6 - 8 - 10 mm 3 Ref. 250R: Ø 12 - 14 - 16 mm 2 Pilot pins Ref. P250CA	HSS	228,57
EFBBMG3	3 Ref. BMG: Ø 6 - 8 - 10 mm 3 Ref. 250C: Ø 12 - 14 - 16 mm 2 Pilot pins Ref. P250CA	HSSCo	290,59



Content: 20 Annular cutters		CFBE01
HSS	Ref. 250R: Ø 14 - 16 - 18 - 20 - 22 - 24 - 26 - 28 - 30 - 32 mm Ref. 500R: Ø 14 - 16 - 18 - 20 - 22 - 24 - 26 - 28 - 30 - 32 mm	
		888,29 €

Content: 20 Annular cutters		CFBE02
HSSCo	Ref. 250C: Ø 14 - 16 - 18 - 20 - 22 - 24 - 26 - 28 - 30 - 32 mm Ref. 500C: Ø 14 - 16 - 18 - 20 - 22 - 24 - 26 - 28 - 30 - 32 mm	
		1.769,48 €

Content: 18 Annular cutters		CFBE03
CARBIDE TIPPED	Ref. 350A: Ø 14 - 16 - 18 - 20 - 22 - 24 - 26 - 28 - 30 - 32 mm Ref. 500A: Ø 18 - 20 - 22 - 24 - 26 - 28 - 30 - 32 mm	
		1.988,88 €

EXPLICATIVE ANNULAR CUTTERS ACCESSORIES EASY USING DIAGRAM

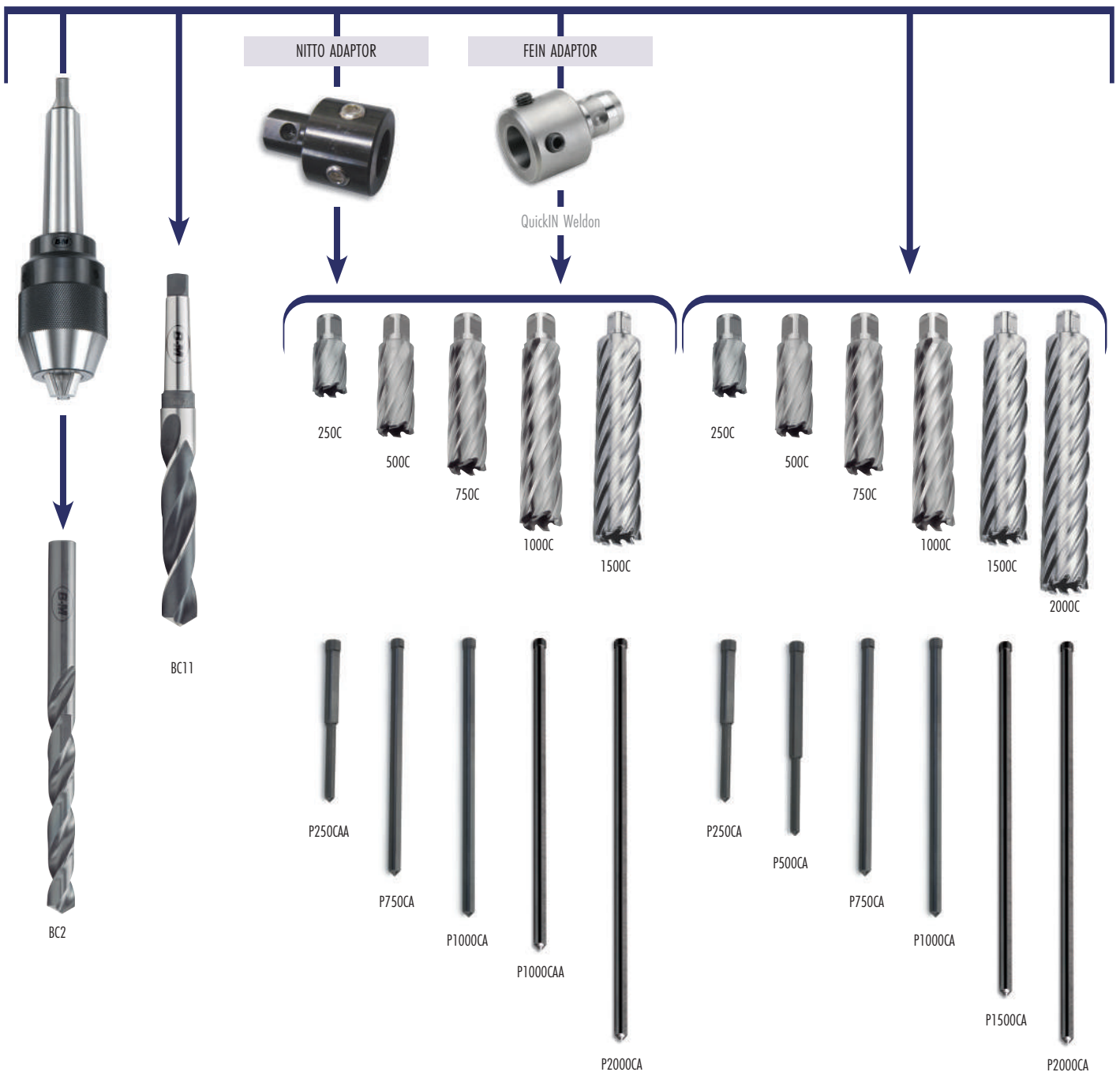

CUTTING CONDITIONS FOR ANNULAR CUTTERS

mm/REV.							
		INOX	CAST IRON	Al	Ni		
250R - 500R - 1500C - 2000C	0,053	-	0,05	0,075	0,12	-	-
250C - 500C - 750C - 1000C - MB350AT - MB500AT	0,063	-	0,055	0,085	0,15	-	-
350A - 500A - 750A - 1000A - MB350ST - MB500ST	0,10	0,075	0,10	0,15	0,22	0,07	

R.P.M. SELECTION FOR HOLESAWS: 250R - 500R - 250C - 500C - 750C - 1000C

100	3183	2122	1952	1273	1061	909	796	637	531	455	398	354	318
95	3024	2016	1512	1512	1008	864	756	605	504	432	378	336	302
90	2865	1910	1432	1432	955	819	716	573	477	409	358	318	286
85	2706	1804	1353	1353	902	773	676	541	451	387	338	301	271
80	2547	1698	1273	1276	849	728	637	509	424	364	318	283	255
75	2387	1592	1194	1194	796	682	597	477	398	341	298	265	239
70	2228	1485	1114	1114	743	637	557	446	371	318	279	248	223
65	2069	1379	1035	1035	690	591	517	414	345	296	259	230	207
60	1910	1273	955	922	637	546	477	382	318	273	239	212	191
55	1751	1167	875	875	584	500	438	350	292	250	219	195	175
50	1592	1061	796	796	531	455	398	318	265	227	199	177	159
45	1432	955	716	716	477	409	658	286	239	205	179	159	143
40	1273	849	637	637	424	364	618	255	212	192	159	141	127
35	1114	743	557	557	371	318	279	223	186	159	139	124	111
30	955	637	477	477	318	273	239	191	159	136	119	106	95
25	796	531	398	398	265	227	199	159	133	114	99	88	80
20	637	424	318	318	212	182	159	127	106	91	80	71	64
15	477	318	239	239	159	136	119	95	80	68	60	53	48
10	318	212	159	159	106	91	80	64	53	45	40	35	32
	10	15	20	25	30	35	40	50	60	70	80	90	100

DIAMETER SELECTION (Ø mm)

R.P.M. SELECTION FOR HOLESAWS: 350A - 500A - 750A - 1000A - MB350ST - MB500ST

100	3183	2122	1952	1273	1061	909	796	637	531	455	398	354	318
95	3024	2016	1512	1512	1008	864	756	605	504	432	378	336	302
90	2865	1910	1432	1432	955	819	716	573	477	409	358	318	286
85	2706	1804	1353	1353	902	773	676	541	451	387	338	301	271
80	2547	1698	1273	1276	849	728	637	509	424	364	318	283	255
75	2387	1592	1194	1194	796	682	597	477	398	341	298	265	239
70	2228	1485	1114	1114	743	637	557	446	371	318	279	248	223
65	2069	1379	1035	1035	690	591	517	414	345	296	259	230	207
60	1910	1273	955	922	637	546	477	382	318	273	239	212	191
55	1751	1167	875	875	584	500	438	350	292	250	219	195	175
50	1592	1061	796	796	531	455	398	318	265	227	199	177	159
45	1432	955	716	716	477	409	658	286	239	205	179	159	143
40	1273	849	637	637	424	364	618	255	212	192	159	141	127
35	1114	743	557	557	371	318	279	223	186	159	139	124	111
30	955	637	477	477	318	273	239	191	159	136	119	106	95
25	796	531	398	398	265	227	199	159	133	114	99	88	80
20	637	424	318	318	212	182	159	127	106	91	80	71	64
15	477	318	239	239	159	136	119	95	80	68	60	53	48
10	318	212	159	159	106	91	80	64	53	45	40	35	32
	10	15	20	25	30	35	40	50	60	70	80	90	100

DIAMETER SELECTION (Ø mm)