

BLUE-MASTER[®]
by *celesa*



CORONAS
CONSTRUCCIÓN

CORONA EXTRA PROFESIONAL DIENTES DE METAL DURO Y MANGO SDS-PLUS

Coronas

Rosa

Ref. 600W



MD

80 mm
CAPACIDAD
DE CORTE

- Para trabajar con este tipo de coronas se precisan de tres elementos, que se facturan de forma independiente:
 - Corona: Disponible en los diámetros indicados.
 - Husillo mango SDS-Plus en sus diferentes longitudes con rosca redonda.
 - Punzón centrador.
- No taladrar metales, ni porcelánico, ni hormigón armado.
- Sacar la corona del orificio practicado en rotación.
- Cuando tenga que emplear husillos largos, utilice previamente los cortos hasta su límite, con motivo de prevenir su rotura debido a la torsión creciente a través del mismo.
- Trabajar a 700 R.P.M.
- Trabajos en percusión.

600W		
	Ø mm	€
600W25C	25	82,85*
600W29C	29	88,35*
600W65C	65	177,66*
600W70C	70	190,89*
600W75C	75	204,10*
600W80C	80	217,32*

- El precio no incluye husillo, ni punzón centrador.

*Hasta fin de existencias



MAYOR RESISTENCIA DE LA CORONA
GRACIAS A SU MANGO
EXTRA ROBUSTO



Ref. 600WSDS1105



Ref. 600WSDS1200



Ref. 600WSDS1300



Ref. 600WSDS2105



Ref. 600WSDS2200



Ref. 600WSDS2300



Ref. 600WP

HUSILLOS PARA CORONAS EXTRA PROFESIONALES

	DESCRIPCIÓN	RANGO Ø mm	€
600WSDS1105	Husillo SDS Plus 105 mm	25 - 38	22,43
600WSDS1200	Husillo SDS Plus 200 mm	25 - 38	27,77
600WSDS1300	Husillo SDS Plus 300 mm	25 - 38	32,97
600WSDS2105	Husillo SDS Plus 105 mm	45 - 100	25,10
600WSDS2200	Husillo SDS Plus 200 mm	45 - 100	37,03
600WSDS2300	Husillo SDS Plus 300 mm	45 - 100	48,81
600WP0	Punzón centrador	25 - 29	31,72
600WP1	Punzón centrador	32 - 38	31,72
600WP2	Punzón centrador	45 - 100	31,72

CORONA EXTRA PROFESIONAL HÍBRIDA DIENTES DE METAL DURO

Ref. CW



95 mm
CAPACIDAD
DE CORTE

Coronas

Rosa



- Para trabajar con este tipo de coronas se precisan de tres elementos, que se facturan de forma independiente:
 - Corona: Disponible en los diámetros indicados.
 - Husillo mango SDS-Plus y SDS-Max en sus diferentes longitudes con rosca redonda.
 - Punzón centrador.
- No taladrar metales, ni porcelánico, ni hormigón armado.
- Sacar la corona del orificio practicado en rotación.
- Trabajar a 700 R.P.M.

CW		
	Ø mm	€
CW25	25	64,31
CW27	27	65,20
CW30	30	74,83
CW35	35	82,55
CW40	40	95,35
CW45	45	110,23
CW50	50	122,53
CW60	60	139,12
CW65	65	167,43
CW68	68	177,60
CW70	70	182,50
CW75	75	196,17
CW80	80	214,45
CW90	90	222,15
CW95	95	257,76
CW100	100	283,82
CW105	105	303,63
CW110	110	335,58
CW115	115	373,35
CW120	120	373,35
CW130	130	426,02
CW140	140	490,29
CW150	150	512,10
CW160	160	582,92
CW170	170	633,05
CW180	180	686,43
CW190	190	787,19
CW200	200	838,98



**MAYOR RESISTENCIA DE LA CORONA
GRACIAS A SU MANGO
EXTRA ROBUSTO**

* El precio no incluye husillo, ni punzón centrador.



Ref. CWSDS-105



Ref. CWSDS-200



Ref. CWSMAX-105



Ref. CWSMAX-200



Ref. CWBR

HUSILLOS PARA CORONAS EXTRA PROFESIONALES

	DESCRIPCIÓN	RANGO Ø mm	€
CWSDS-105	Husillo SDS Plus 105 mm	25 - 200	32,61
CWSDS-200	Husillo SDS Plus 200 mm	25 - 200	51,32
CWSDS-300	Husillo SDS Plus 300 mm	25 - 200	67,91
CWSDS-450	Husillo SDS Plus 450 mm	25 - 200	91,97
CWSMAX-200	Husillo SDS Max 200 mm	25 - 200	51,32
CWSMAX-300	Husillo SDS Max 300 mm	25 - 200	67,91
CWSMAX-450	Husillo SDS Max 450 mm	25 - 200	91,97
CWBR	Broca guía Ø10 x 160 mm	25 - 200	19,56

CORONA PARA CONSTRUCCIÓN DIENTES DE METAL DURO MANGO SISTEMA SDS-PLUS Y HEXAGONALES DE 11 mm.

Coronas

Rosca

Ref. HA

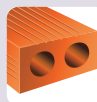

MD

54 mm
CAPACIDAD
DE CORTE

- El conjunto se compone de tres piezas:
 - Corona: Disponible en los diámetros indicados
 - Husillos: Rosca M16 x 2. Disponible en mango cilíndrico o SDS PLUS
 - Broca Guía Ø 8 mm
- No taladrar metales, ni porcelánico, ni hormigón armado.
- Sacar la corona del orificio practicado en rotación.
- Trabajar a 700 R.P.M.
- Trabajos en percusión.

HUSILLOS MANGO HEXAGONAL DE 11mm

HA			
	Ø mm	Z	€
HA25	25	4	57,79
HA30	30	6	61,97
HA35	35	6	66,47
HA40	40	6	72,46
HA45	45	6	76,36
HA50	50	6	83,10
HA60	60	6	88,36
HA68	68	6	92,47
HA70	70	6	100,25
HA80	80	6	115,36
HA90	90	6	141,69
HA100	100	6	160,64
HA115	115	6	201,36
HA125	125	6	225,36
HA130	130	6	256,98

* El precio no incluye husillo, ni broca guía.

	DESCRIPCIÓN	RANGO Ø mm	€
HA11X100	Corto. Mango 100 mm	Portabrocas	29,05
HA11X220	Largo. Mango 220 mm	hasta 13 mm	40,76
HA11X320	Extralargo. Mango 320 mm	de capacidad	49,56

HUSILLOS CON MANGO SDS PLUS

	DESCRIPCIÓN	€
HA100SDS	Extra corto. Mango SDS PLUS 100 mm	34,83
HA170SDS	Corto. Mango SDS PLUS 170 mm	39,36
HA220SDS	Largo. Mango SDS PLUS 220 mm	46,63
HA320SDS	Extralargo. Mango SDS PLUS 320 mm	56,46

BROCA GUÍA Ø 8 x 100 mm

HA8
9,92 €
HUSILLOS INTEGRALES SDS PLUS "ANTIROTURA"

	DESCRIPCIÓN	€
HA175SDSM	Corto. SDS PLUS 175 mm	78,72
HA340SDSM	Largo. SDS PLUS 340 mm	102,69
HA440SDSM	Extralargo. SDS PLUS 440 mm	120,14

CORONA DE CONSTRUCCIÓN LIGERA, DIENTES DE METAL DURO MANGO HEXAGONAL Y SDS PLUS

Ref. MD



MD



60 mm
CAPACIDAD
DE CORTE



- El conjunto se compone de tres piezas:
 - Corona: Disponible en los diámetros indicados
 - Husillos: Rosca M16 x 2. Disponible en mango hexagonal o SDS PLUS
 - Broca Guía Ø 8 mm
- No taladrar metales, ni porcelánico, ni hormigón armado.
- Sacar la corona del orificio practicado en rotación.
- Trabajar a 700 R.P.M.
- Trabajos en percusión.

HUSILLOS MANGO HEXAGONAL DE 11mm



HUSILLOS CON MANGO SDS PLUS



MD		
	Ø mm	€
MD22SH	22	33,70
MD25SH	25	40,98
MD27SH	27	41,56
MD30SH	30	47,68
MD35SH	35	52,62
MD40SH	40	60,76
MD45SH	45	67,17
MD50SH	50	69,20
MD60SH	60	78,88
MD65SH	65	79,34
MD68SH	68	79,43
MD70SH	70	103,38
MD75SH	75	111,13
MD80SH	80	113,90
MD90SH	90	117,99
MD95SH	95	127,77
MD100SH	100	134,23
MD120SH	120	159,76

	DESCRIPCIÓN	RANGO Ø mm	€
HA11X100	Corto. Mango 100 mm	Portabrocas	29,05
HA11X220	Largo. Mango 220 mm	hasta 13 mm	40,76
HA11X370	Extralargo. Mango 370 mm	de capacidad	49,56

	DESCRIPCIÓN	€
HA100SDS	Extra corto. Mango 100 mm	34,83
HA170SDS	Corto. Mango 170 mm	39,36
HA220SDS	Largo. Mango 220 mm	46,63
HA320SDS	Extralargo. Mango 320 mm	56,46

HUSILLOS INTEGRALES SDS PLUS "ANTIROTURA"



	DESCRIPCIÓN	€
HA175SDSM	Corto. SDS PLUS 175 mm	78,72
HA340SDSM	Largo. SDS PLUS 340 mm	102,69
HA440SDSM	Extralargo. SDS PLUS 440 mm	120,14

BROCA GUÍA Ø 8 x 100 mm



HA8
9,92€

* El precio no incluye husillo, ni broca guía.

CONJUNTO PASAMUROS, HUSILLO, BROCA GUÍA Y CORONA

NEW

Ref. MD



MD



60 mm
CAPACIDAD
DE CORTE



	Ø mm	DESCRIPCIÓN	€
MD50SDSB	50	Mango SDS PLUS M16	75,36
MD60SDSB	60		86,36
MD68SDSB	68		88,36
MD90SDSB	90		130,36

CORONA DE CONSTRUCCIÓN PESADA PARA HORMIGÓN ARMADO MANGO SDS MAX

CoronMS

Rosa

Ref. MH

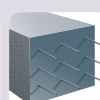
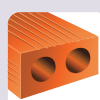

MD

100 mm
CAPACIDAD
DE CORTE

- No utilizar en metal, ni cerámicas.
- Ligeros empujes axiales, que habrá que reducir aún más al comenzar a trabajar la ferralla.
- Quitar el punzón cuando la corona haya penetrado en el material.
- Trabajar a 500 R.P.M.
- Trabajos en percusión.



1- Utilizar el punzón guía al iniciar el taladro.

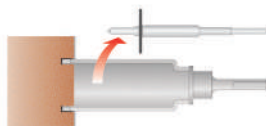

2- Extraemos el punzón cuando la corona haya penetrado levemente.



	MH		
	Ø mm	Z	€
MH25	25	4	128,80
MH29	29	4	137,45
MH32	32	4	153,00
MH35	35	4	170,08
MH38	38	4	188,96
MH45	45	6	214,64
MH50	50	8	228,43
MH55	55	10	240,53
MH60	60	10	259,41
MH65	65	10	276,45
MH70	70	12	297,21
MH75	75	12	317,74
MH80	80	12	338,31
MH90	90	14	386,36
MH100	100	16	431,13
MH120	120	18	523,75
MH150	150	24	733,83



MAYOR RESISTENCIA DE LA CORONA
GRACIAS A SU MANGO
EXTRA ROBUSTO

El precio no incluye husillo, ni punzón centrador.

HUSILLOS PARA CORONAS EXTRA PROFESIONALES

	DESCRIPCIÓN	RANGO Ø mm	€
MHSK1 MAX	Husillo SDS MAX Lt:300 mm	25 - 35	105,67
MHSK2 MAX	Husillo SDS MAX Lt:300 mm	38 - 150	110,06
MHCP0	Punzón centrador Nº 0	25 - 29	58,72
MHCP1	Punzón centrador Nº 1	32 - 35	58,72
MHCP2	Punzón centrador Nº 2	38 - 150	58,72



Ref. MHSK1 MAX



Ref. MHCP

CORONA PESADA PARA CONSTRUCCIÓN, DIENTES DE METAL DURO SUJECIÓN CÓNICA 1:8 ANTI-ROTURA

NEW

Ref. CLA



MD

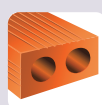

Corona pesada para alto rendimiento en martillos eléctricos con potencia de impacto mayor de $\geq 900w$.
Dientes de metal duro inclinados en perfecta posición para un potente ataque.
Husillo y corona tratados térmicamente para una mayor resistencia y rendimiento.
Amarre cónico 1:8 hace mas solidaria la unión husillo-corona y mejora la transmisión de potencia.

70 mm
CAPACIDAD DE CORTE

HUSILLOS CON MANGO SDS MAX



Amarre Cónico 1:8

Amarre Cónico 1:8



	DESCRIPCIÓN	€
CLAMAX220	Mango SDS MAX. Lt:220 mm	75,54
CLAMAX420	Mango SDS MAX. Lt:420 mm	89,02
CLAMAX700	Mango SDS MAX. Lt:700 mm	145,69
CLAMAX900	Mango SDS MAX. Lt:900 mm	198,36

*Consulte la gama de husillos con mango estriado y mango hexagonal 13 mm disponibles.

	CLA	
	Ø mm	€
CLA030	30	129,39
CLA035	35	135,36
CLA040	40	138,98
CLA045	45	150,36
CLA050	50	162,35
CLA055	55	175,68
CLA060	60	179,36
CLA066	66	181,25
CLA068	68	186,35
CLA070	70	222,22
CLA080	80	245,43
CLA090	90	283,46
CLA100	100	306,26
CLA110	110	335,36
CLA115	115	348,67
CLA125	125	362,37
CLA150	150	469,07

* El precio no incluye husillo, ni broca guía.

KIT EXTRACCIÓN PARA CORONA CLA y PM



CLAEX
42,36

BROCAS GUÍA CORONAS CLA y PM Ø11x130 mm



CLA11
15,80

CORONA PESADA INTEGRAL PASAMUROS, DIENTES DE METAL DURO ANTIROTURA

NEW

Ref. PM



MD



Corona pesada integral para alto rendimiento en martillos eléctricos de alta potencia.
Corona con husillo integrado mejora la transmisión de potencia en la operación.
Dientes de metal duro inclinados en perfecta posición para un potente ataque.
Husillo y corona tratados térmicamente para una mayor resistencia y rendimiento.

190-450
CAPACIDAD DE CORTE



SISTEMA PARA TALADRAR UN ORIFICIO PROFUNDO CON CORONAS DE CONSTRUCCIÓN

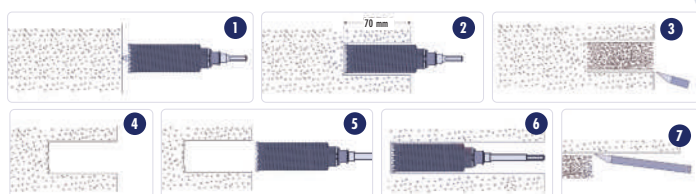

	PM		
	Ø mm	Capacidad Corte mm	€
PM45X300	45	190	284,06
PM45X560	45	450	297,54
PM50X300	50	190	296,05
PM50X560	50	450	309,53
PM55X300	55	190	309,38
PM55X560	55	450	322,86
PM68X300	68	190	320,05
PM68X560	68	450	333,53
PM80X300	80	190	379,13
PM80X560	80	450	392,61
PM90X300	90	190	417,16
PM90X560	90	450	430,64
PM100X300	100	190	439,96
PM100X560	100	450	453,44
PM125X560	125	450	509,55
PM150X560	150	450	616,25

*El precio incluye broca guía CLA11 y kit de extracción CLAEX

CORONA DIAMANTE ELECTRODEPOSITADO PARA GRANITO, MÁRMOL, PORCELÁNICOS Y PLÁSTICOS REFORZADOS

Coronas

Gris

Rosa

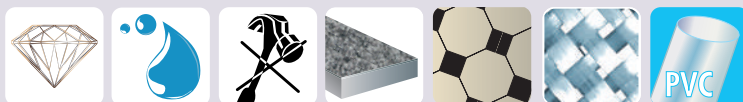
 Ref. CDE
 Ref. CMAD

40 mm
CAPACIDAD
DE CORTE
MANGO SOLIDARIO

	Ø mm	CDE	€
CDE12	12		57,53
CDE14	14		58,08
CDE16	16		61,39
CDE18	18		64,70
CDE20	20		73,34
CDE25	25		81,27
CDE28	28		84,38
CDE30	30		89,48
CDE32	32		93,72
CDE35	35		97,85
CDE40	40		102,38
CDE43	43		103,65
CDE45	45		104,17
CDE50	50		104,47
CDE65	65		123,35
CDE68	68		138,60
CDE75	75		169,61
CDE80	80		179,21
CDE90	90		203,02
CDE100	100		203,02
CDE120	120		238,24

Estos precios incluyen el husillo y la broca guía.

MANGO INTERCAMBIABLE ROSCADO

- Taladrado seriado de Fibra de Vidrio, Carbono, Poliester,...
- El punzón expulsa el testigo automáticamente.



	Ø mm	CMAD	€
CMAD20	20		147,74
CMAD22	22		154,66
CMAD25	25		159,66
CMAD28	28		163,08
CMAD30	30		165,44
CMAD32	32		170,38
CMAD35	35		196,60
CMAD40	40		206,72
CMAD45	45		218,64
CMAD50	50		230,32

Estos precios no incluyen el husillo.

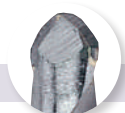
BROCA GUÍA Ø 5 mm

BW90500
26,50 €

- Desmontar la broca guía cuando la corona ya ha penetrado sobre el material.
- Se recomienda la utilización de la guía "GCD" para coronas.
- Sacar la corona del orificio practicado en rotación, para evitar roturas debido al "efecto palanca".
- Debe ser refrigerada con agua.
- Velocidad de corte R.P.M.:
 Ø 100 mm: 400 R.P.M.
 Ø 50 mm: 800 R.P.M.
 Ø 20 mm: 1300 R.P.M.
- Exclusivamente en Rotación, sin percutor.

GUÍA PARA CORONAS
GCD
45,35 €

Capacidad: Ø 10 a 83 mm

BOTE DE REFRIGERACIÓN
GBP
9,73 €

Capacidad: 1,1 l.



GCD



GBP

HUSILLOS CON REFRIGERACIÓN INTERIOR

	DESCRIPCIÓN	€
350MC13	Husillo Mango cilíndrico Ø 13 mm	236,50
350MC16	Husillo Mango cilíndrico Ø 16 mm	236,50



CORONA DE DIAMANTE SEGMENTADA

NEW

Ref. CDD



60 mm
CAPACIDAD
DE CORTE

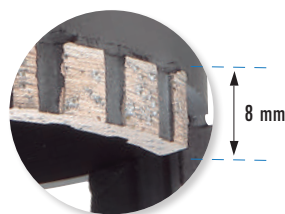

CDD			
	Ø mm	Z	€
CDD08	8	Circular	47,29
CDD10	10	Circular	51,51
CDD12	12	Circular	60,23
CDD15	15	Circular	65,36
CDD20	20	Circular	74,55
CDD26	26	Circular	81,25
CDD30	30	4	95,36
CDD35	35	4	103,36
CDD40	40	4	106,65
CDD45	45	4	110,62
CDD52	52	4	115,22
CDD55	55	4	120,33
CDD68	68	5	142,36
CDD72	72	5	145,25
CDD82	82	6	152,15
CDD92	92	8	162,95
CDD102	102	8	175,89



HUSILLOS PARA CORONAS CDD

	DESCRIPCIÓN	€
CDDHEX	Husillo Mango Hexagonal 10,8 mm Lt:120 mm	20,36
CDDMAX	Husillo Mango SDS Max Lt:200 mm	25,36
CDDPLUS	Husillo Mango SDS Plus Lt:200 mm	22,11

BROCA GUÍA SDS Plus



BROCA DE DIAMANTE SOLDADO AL VACÍO PARA PORCELÁNICO

NEW

Ref. CAH



Serie Diamond

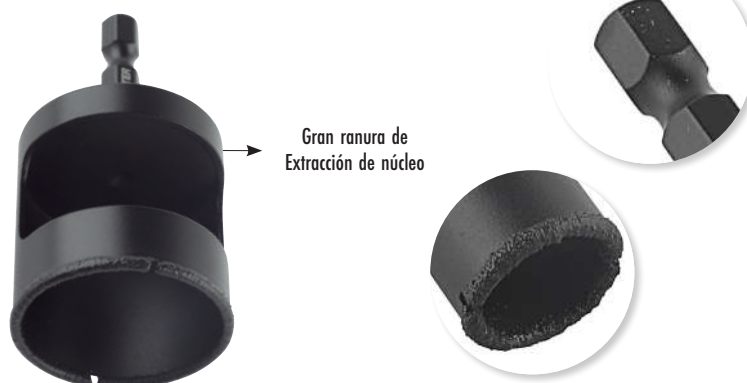
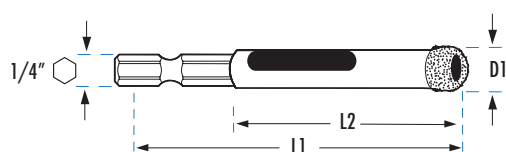

Gran ranura de Extracción de núcleo

CAH				
	D1 mm	Hex	L1 x L2 mm	€
CAH05	5,0	1/4	65 x 30	19,05
CAH06	6,0	1/4	65 x 30	20,42
CAH07	7,0	1/4	65 x 30	23,25
CAH08	8,0	1/4	65 x 30	26,76
CAH10	10,0	1/4	65 x 30	28,23
CAH12	12,0	1/4	65 x 30	34,83
CAH14	14,0	1/4	65 x 30	39,51
CAH15	15,0	1/4	65 x 30	59,81
CAH16	16,0	1/4	65 x 30	62,36
CAH18	18,0	1/4	65 x 30	64,25
CAH20	20,0	1/4	65 x 30	65,45
CAH22	22,0	1/4	65 x 30	71,94
CAH25	25,0	1/4	65 x 30	76,41
CAH28	28,0	1/4	65 x 30	77,36
CAH30	30,0	1/4	65 x 30	83,09
CAH32	32,0	1/4	65 x 30	89,36
CAH35	35,0	1/4	65 x 30	96,36

- Trabajar siempre en rotación.
- Refrigerar con agua abundante durante el taladrado.
- Mango de 1/4" con ranura para cambio rápido.
- Diseñada con GRAN RANURA LATERAL para extracción de núcleo de perforación.
- La broca CAH taladra porcelánico siempre que se garantice que exista agua entre el diamante y la pieza a trabajar.
- Jamás introducir en agua la broca CAH tras el taladrado. Una vez haya alcanzado altas temperaturas, dejar enfriar al aire.
- Comenzar a perforar con la broca inclinada (ángulo de 15° a 30°) y enderezarla progresivamente. No hay necesidad de guías.
- Taladrar el porcelánico realizando suaves movimientos giratorios, para facilitar la posterior extracción del núcleo.
- Antes de finalizar el trabajo, deje de presionar con fuerza para evitar que el núcleo de perforación se pegue al interior de la corona.
- Más perforaciones en menos tiempo y con menos esfuerzo.

Coronas

Rosa Gris

CORONA DE DIAMANTE HORMIGÓN ARMADO

300-450
CAPACIDAD
DE CORTE

Ref. CHH

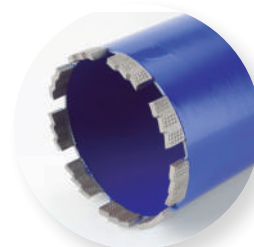

1" 1/4

- Nueva Corona Segmentada para trabajo pesado en construcción.
- Alto rendimiento en trabajo intensivo en hormigón armado, hormigón abrasivo, granito, piedra, ladrillo y asfalto.
- Refrigerar con agua abundante.
- Trabajo constante y eficaz que alarga la vida de la herramienta y máquina.
- Segmentos más resistentes y con mayor contenido en diamante para obtener el máximo rendimiento.
- Mejor evacuación de escombros, menor esfuerzo en máquina.
- Óptima gestión del esfuerzo en máquina de alta potencia.

CHH

	Ø mm	L1 mm	L2 mm	Z	KW	€
CHH32	32	380	300	3	0,7>1,2	152,00
CHH42	42	380	300	4	0,7>1,2	165,82
CHH52	52	520	450	5	0,7>1,2	179,65
CHH62	62	520	450	6	0,7>1,2	207,29
CHH72	72	520	450	6	0,7>1,2	248,78
CHH82	82	520	450	7	1,2>2,3	262,61
CHH92	92	520	450	8	1,2>2,3	304,06
CHH102	102	520	450	9	1,2>2,3	331,74
CHH112	112	520	450	9	1,2>2,3	345,55
CHH122	122	520	450	10	1,2>2,3	373,19
CHH127	127	520	450	11	1,2>2,3	393,86
CHH132	132	520	450	11	1,2>2,3	414,67
CHH142	142	520	450	12	1,2>2,3	483,79
CHH152	152	520	450	12	1,2>2,3	483,79
CHH162	162	520	450	12	2,3>3,9	511,45
CHH172	172	520	450	13	2,3>3,9	580,56
CHH182	182	520	450	13	2,3>3,9	594,39
CHH200	200	520	450	15	2,3>3,9	663,52
CHH225	225	520	450	15	2,3>3,9	787,92
CHH250	250	520	450	16	2,3>3,9	870,86
CHH300	300	520	450	17	2,3>3,9	1.105,90

HUSILLOS PARA CHH

SDS
Plus

DESCRIPCIÓN

€

ADCHH-PLUS

Mango SDS Plus. Lt:200 mm

64,85

SDS
Max

DESCRIPCIÓN

€

ADCHH-MAX

Mango SDS MAX. Lt:200 mm

67,44



DESCRIPCIÓN

€

ADCHH-HEX

Mango Hexagonal. Lt:200 mm

58,61

CORONA DE DIAMANTE SOLDADO AL VACÍO PARA GRANITO, MÁRMOL Y PORCELÁNICOS

Ref. CSE

**SERIE
DIAMOND**



M14x2

**35 mm
CAPACIDAD
DE CORTE**



**ESPECIAL
TRABAJO
EN SECO**



M14x2
Especial amoladoras angulares
(radiales)

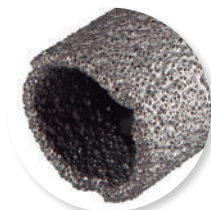

	CSE	
	Ø mm	€
CSE05*	5	56,78
CSE06*	6	56,95
CSE08*	8	57,43
CSE10*	10	58,06
CSE12*	12	59,26
CSE14*	14	59,82
CSE16	16	63,22
CSE18	18	66,63
CSE20	20	75,52
CSE22	22	78,61
CSE25	25	83,68
CSE27	27	86,65
CSE30	30	92,15
CSE32	32	96,51
CSE35	35	100,77
CSE38	38	102,51
CSE40	40	105,42
CSE45	45	107,28
CSE50	50	107,60
CSE51	51	111,69
CSE55	55	113,83
CSE57	57	120,17
CSE60	60	124,05
CSE65	65	127,03
CSE67	67	136,57
CSE68	68	142,74
CSE70	70	156,46
CSE75	75	174,67
CSE80	80	184,57
CSE83	83	208,57
CSE90	90	230,16
CSE95	95	245,77
CSE100	100	256,20
CSE110	110	285,33
CSE120	120	297,81
CSE130	130	313,30
CSE140	140	324,85
CSE150	150	335,25



- Especial para trabajar en porcelánico en SECO si bien el agua aumenta exponencialmente su rendimiento.
- Amarre con rosca hembra M14X2 para trabajar con amoladoras angulares (radiales).
- Empezar a perforar con la corona ligeramente inclinada (ángulo de 15° o 30°) y enderezarla progresivamente, sin necesidad de guías.
- Taladrar el porcelánico realizando suaves movimientos giratorios para facilitar la posterior extracción del núcleo.
- Mas perforaciones en mismo tiempo y con menos esfuerzo.
- Extraer el núcleo de perforación tras cada taladro.

ADAPTADORES PARA CSE



ALCSEX50



ADCSE-MAX



ADCSE-PLUS

	DESCRIPCIÓN	L mm	€
ALCSEX50	Alargador 50mm CSE M14X2,00 Ø22mm	50	15,22
ALCSEX75	Alargador 75mm CSE M14X2,00 Ø22mm	75	17,40
ADCSE-MAX	Adaptador CSE M14X2,00 SDS MAX	113	37,81
ADCSE-PLUS	Adaptador CSE M14X2,00 SDS PLUS	90	21,46

LATA DE PARAFINA LUBRICANTE



20 cm3

**PACSE
9,17 €**

Estos precios no incluyen el husillo

* Ø 5 a 14 mm la corona contiene parafina vegetal de refrigeración.

HUSILLO MANGO HEXAGONAL PARA CSE



**ADCSE
15,55 €**

BROCA GUÍA PARA HUSILLO ADCSE OPCIONAL



**BW90500
26,50 €**

JUEGO DE CORONAS DE DIAMANTE SOLDADO AL VACÍO PARA GRANITO, MÁRMOL Y PORCELÁNICOS

Ref. CSE

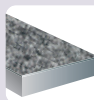
35 mm
CAPACIDAD
DE CORTE
Especial
Trabajo
en Seco
Serie
Diamond

CORONAS

ROSA

JUEGO DE 4 CORONAS CSE + HUSILLO+ PARAFINA

Parafina Vegetal



M14x2

 Especial amoladoras angulares
 (radiales)

CSE9328

4 Coronas CSE: Ø 5 - 6 - 8 - 10 mm

1 Husillo Ref.ADCSE

1 Bote de Parafina Vegetal Ref. PACSE 20 cm3

193,11 €

AVELLANADORES DE DIAMANTE SOLDADO AL VACÍO PARA GRANITO, MÁRMOL Y PORCELÁNICOS

Ref. AVD

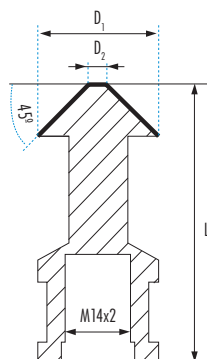

M14x2

Especial
Trabajo
en Seco
Serie
Diamond

- Especial para trabajar en porcelánico en SECO si bien el agua aumenta exponencialmente su rendimiento.
- Amarre con rosca hembra M14X2 para trabajar con amoladoras angulares (radiales)

	AVD					
	D1 mm	D2 mm	α	L1 mm		€
AVD0630	6,30	1,50	90°	45	M14X2	86,56
AVD0830	8,30	2,00	90°	50	M14X2	86,56
AVD1040	10,40	2,50	90°	50	M14X2	86,56
AVD1240	12,40	2,80	90°	56	M14X2	95,21
AVD1650	16,50	3,20	90°	60	M14X2	103,86
AVD2050	20,50	3,50	90°	63	M14X2	108,20
AVD2500	25,00	3,80	90°	67	M14X2	135,25
AVD3100	31,00	4,20	90°	71	M14X2	167,71

CORONA DE CARBURO DE TUNGSTENO PARA MATERIALES NO METÁLICOS

Ref. MG



30 mm
CAPACIDAD
DE CORTE



ACABADOS MUY FINOS

- Excelente comportamiento en aglomerado y madera.



Ø mm	Cartón		Blister	
	Ref.	€	Ref.	€
16	MG16	18,68	MG16B	18,68
19	MG19	19,61	MG19B	19,61
20	MG20	20,11	MG20B	20,11
22	MG22	20,11	MG22B	20,11
25	MG25	20,56	MG25B	20,56
29	MG29	22,17	MG29B	22,17
32	MG32	22,46	MG32B	22,46
35	MG35	23,24	MG35B	23,24
38	MG38	25,37	MG38B	25,37
44	MG44	27,10	MG44B	27,10
48	MG48	27,64	MG48B	27,64
51	MG51	27,64	MG51B	27,64
54	MG54	28,83	MG54B	28,83
57	MG57	28,95	MG57B	28,95
60	MG60	30,98	MG60B	30,98
64	MG64	30,98	MG64B	30,98
70	MG70	39,44	MG70B	39,44
76	MG76	42,31	MG76B	42,31
83	MG83	43,21	MG83B	43,21
86	MG86	45,39		
95	MG95	48,00		
102	MG102	48,90		
114	MG114	50,55		

* El precio no incluye husillo, ni broca guía.

HUSILLOS PARA CORONAS Ref. MG

	Ø mm	EMBALAJE	€
B5519-CM	16 - 29	En caja	19,51
B5546-CM	32 - 114	En caja	29,60
B5519-CMS	16 - 29	En blister	19,51
B5546-CMS	32 - 114	En blister	29,60



BROCAS GUÍA CON PUNTA DE METAL DURO Ø 6,35 mm

	LTmm	EMBALAJE	€
B8537	82 mm	En caja	5,63
B8538	97 mm	En caja	5,63
B8537S	82 mm	En blister	7,02
B8538S	97 mm	En blister	7,02

ESTUCHE CORONAS MASTER-GRIT



Ref. MG9573



Ref. MG9572

MG9571 6 Coronas MG:
22 - 35 - 51 - 60 - 64 - 70 mm

Contenido

- 1 Husillo Ref. B5519-CM ⬡ 9,5 Capacidad 14-30
- 1 Husillo Ref. B5546-CM ⬡ 9,5 Capacidad 32-250
- 1 Adaptador husillo Ref. B5511

184,33 €

MG9572 10 Coronas MG:
20-22-25-32-35-38-44-60-70-76 mm

Contenido

- 1 Husillo Ref. B5519-CM ⬡ 9,5 Capacidad 14-30
- 1 Husillo Ref. B5546-CM ⬡ 9,5 Capacidad 32-250
- 1 Adaptador husillo Ref. B5511

263,76 €

MG9573 7 Coronas MG:
20 - 25 - 29 - 38 - 44 - 60 - 70 mm

Contenido

- 1 Husillo Ref. B5519-CM ⬡ 9,5 Capacidad 14-30
- 1 Husillo Ref. B5546-CM ⬡ 9,5 Capacidad 32-250
- 1 Adaptador husillo Ref. B5511

194,99 €

CORONA DE ALTO RENDIMIENTO PARA MADERA CON DIENTES DE METAL DURO

Coronas

Rosa

Ref. CM

MD

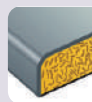
60 mm
CAPACIDAD
DE CORTE

- Elevada velocidad de corte.
- Gran desahogo lateral.
- Larga duración, incluso en materiales abrasivos.
- Óptimo acabado del agujero.
- Exclusivamente en Rotación.

CM

	Ø mm	€
CM022	22	30,88
CM025	25	33,40
CM027	27	34,95
CM030	30	38,39
CM032	32	41,70
CM035	35	41,70
CM038	38	49,99
CM040	40	49,99
CM045	45	54,23
CM050	50	59,14
CM055	55	62,21
CM060	60	67,72
CM062	62	76,28
CM065	65	76,28
CM068	68	84,01
CM070	70	87,09
CM075	75	99,56
CM080	80	99,56
CM090	90	109,75
CM095	95	122,93
CM100	100	122,93
CM110	110	144,59
CM120	120	162,34
CM125	125	172,54
CM130	130	196,87
CM140	140	220,69
CM150	150	227,71
CM160	160	244,49

VELOCIDAD DE CORTE

RANGO Ø mm	R.P.M.
22 - 27	2.800
30 - 38	2.300
40 - 50	1.800
55 - 60	1.500
62 - 80	1.000
90 - 100	700
108 - 125	500

Estos precios incluyen el husillo y la broca guía.

HUSILLOS PARA CORONAS DE MADERA

Ref. CMB5520



Ref. CMB5545



Ref. CMB5556SDS

DESCRIPCIÓN
€

CMB5520	Mango hexagonal 11 mm coronas Ø 22-40 mm	20,70
CMB5529SDS	Mango SDS PLUS coronas Ø 22-40 mm	23,45
CMB5545	Mango hexagonal 11 mm coronas Ø 45-160 mm	28,00
CMB5556SDS	Mango SDS PLUS coronas Ø 45-160 mm	43,43

BROCA GUÍA Ø 6,35 x 107 mm

Ref. B8535

B8535
6,49 €

CORONA CORTACÍRCULOS DE 200 mm

200 mm

**PLADUR
ESCAYOLA**



- Coronas Cortacírculos multifunción con cuchillas ajustables.
- Para corte de círculos en techos, paredes y suelos. Recoge la viruta para realizar un trabajo limpio.
- Realiza cortes en: madera laminada, madera contrachapada, yeso laminado, planchas acrílicas, plomo, pizarra, revestimientos, etc...
- Para corte Aluminio, latón, chapas de metal hasta 1 mm de espesor.
- La medida mínima que se puede taladrar es la misma para todos los cortacírculos, 40 mm.
- Cuchilla CL12-BT002 instalada y CL12-BH002 de repuesto incluida en el maletín.

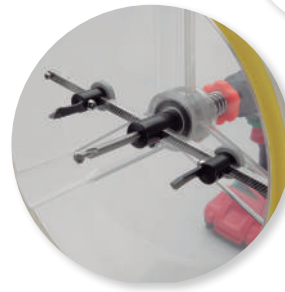

CORONA CORTACÍRCULOS 200 mm

TB-9600-200
250,85 €

REPUESTOS



CL12-BT002



CL12-BH002

	DESCRIPCIÓN	€
CL12-BH002	Cuchilla para todo tipo de maderas, pladur, paneles laminados, etc...	20,89
CL12-BT002	Cuchilla para yeso, escayola, falsos techos en general y metales hasta 1mm de espesor	26,45

CORONA CORTACÍRCULOS DE 220 y 285 mm
220 mm y 285 mm
**PLADUR
ESCAFOYA**

- Coronas Cortacírculos multifunción con cuchillas ajustables.
- Para corte de círculos en techos, paredes y suelos. Recoge la viruta para realizar un trabajo limpio.
- Realiza cortes en: madera laminada, madera contrachapada, yeso laminado, planchas acrílicas, plomo, pizarra, revestimientos, etc...
- Para corte Aluminio, latón, chapas de metal hasta 1 mm de espesor.
- La medida mínima que se puede taladrar es la misma para todos los cortacírculos, 40 mm.
- Cuchilla CL12HSS instalada

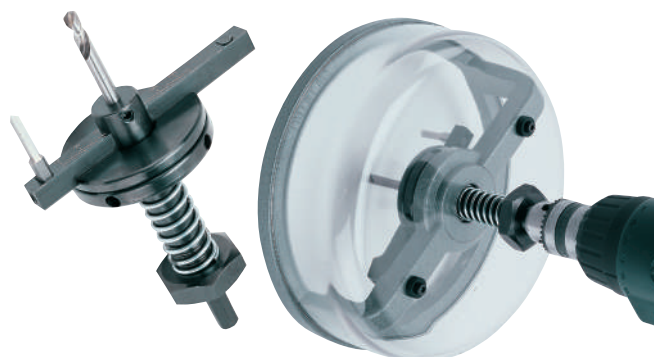

CORONA CORTACÍRCULOS 220 mm
**CL220
262,63 €**
CORONA CORTACÍRCULOS 285 mm
**CL285
302,02 €**

REPUESTOS PARA CORTACÍRCULOS CL220 Y CL285

CL12HSS: Cuchilla para Yeso, Pladur, Falsos techos en general, Madera, Panel laminado, Fenólico, etc..

CL12WID: Cuchilla para corte de Metales hasta 1mm de espesor.

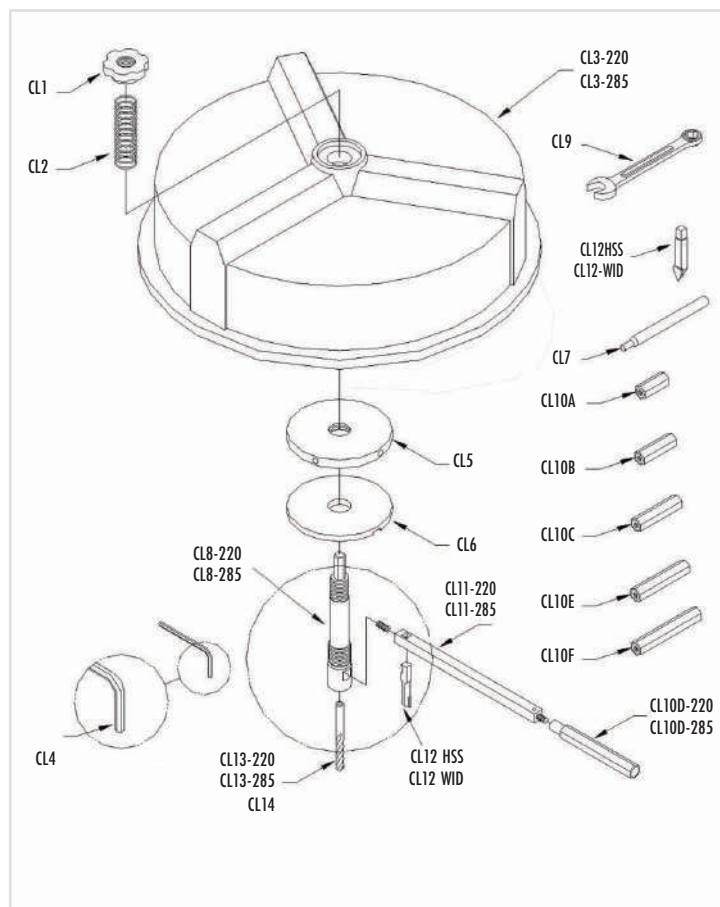
	DESCRIPCIÓN	€
CL1	Tuerca hexagonal 220/285	9,59
CL2	Muelle compresion 220/285	2,69
CL3-220	Taza con rodamiento 220	95,85
CL3-285	Taza con rodamiento 285	142,70
CL4	Llave allen 220/285 (3 mm)	2,71
CL5	Plato fijador 220/285	18,67
CL6	Plato ajuste 220/285	7,99
CL7	Varilla ajuste 220/285	5,40
CL8-220	Eje vertical 220	42,63
CL8-285	Eje vertical 285	45,32
CL9	Llave combinada 220/285	7,99
CL10A	Contrapeso p/d220-cl285-cl410 de 33mm	3,85
CL10B	Contrapeso p/d220-cl285-cl410 de 40mm	4,36
CL10C	Contrapeso p/d220-cl285-cl410 de 56mm	5,06
CL10D-220	Contrapeso p/d220 de 74 mm	5,40
CL10D-285	Contrapeso p/d285-cl410 de 74 mm	5,40
CL10E	Contrapeso p/d285-cl410 de 95 mm	6,98
CL10F	Contrapeso p/d285-cl410 de 120 mm	9,26
CL10-285	Juego balances coronas d285 (6pcs)	15,87
CL11-220	Eje transversal para 220	18,67
CL11-285	Eje transversal para 285	26,33
CL12HSS	Cuchilla para cortacírculos HSS	21,35
CL12WID	Cuchilla para cortacírculos MD	27,99
CL13-220	Broca hss p/cortacirc. 220	17,82
CL13-285	Broca hss p/cortacirc. 285	18,41
CL14	Broca guía HSS 220/285	20,19



CORONA CORTACÍRCULOS DE Ø 410 mm

410 mm

**PLADUR
ESCAVOLA**



- Mayor amplitud de diámetros.
- Plaquita de Metal duro de geometría innovadora de alta resistencia.
- Mejor acabado de orificio.
- Los repuestos de las coronas 160 mm, 220 mm, 260 mm y 285 mm son válidos para la CL410 con excepción de los contrapesos CL10G y CL10H.
- Cuchilla CL12HSS instalada



CORONA CORTACÍRCULOS 410 mm

**CL410
513,52 €**

REPUESTOS



CL12HSS: Cuchilla para Yeso, Pladur, Falsos techos en general, Madera, Panel laminado, Fenólico, etc..



CL12WID: Cuchilla para corte de Metales hasta 1mm de espesor.

	DESCRIPCIÓN	€
CL1	Tuerca hexagonal 220, 285 y 410	9,59
CL2	Muelle compresion 220, 285 y 410	2,69
CL3-410	Taza con rodamiento 410	173,16
CL4	Llave allen 220/285 (3 mm)	2,71
CL5	Plato fijador 220, 285 y 410	18,67
CL6	Plato ajuste 220, 285 y 410	7,99
CL7	Varilla ajuste 220, 285 y 410	5,40
CL8-410	Eje vertical 410	63,89
CL9	Llave combinada 220, 285 y 410	7,99
CL10A	Contrapeso p/d220-d285-cl410 de 33 mm	3,85
CL10B	Contrapeso p/d220-d285-cl410 de 40 mm	4,36
CL10C	Contrapeso p/d220-d285-cl410 de 56 mm	5,06
CL10E	Contrapeso p/d285-cl410 de 95 mm	6,98
CL10F	Contrapeso p/d285-cl410 de 120 mm	9,26
CL10G	Contrapeso p/d410 de 145 mm	11,43
CL10H	Contrapeso p/d410 de 175 mm	14,48
CL11-410	Eje transversal para cl410	38,20
CL12HSS	Cuchilla para cortacirculos HSS	21,35
CL12WID	Cuchilla para cortacirculos MD	27,99
CL13-285	Broca guía metal duro 285 y 410	18,41
CL14	Broca guía HSS 285 Y 410	20,19

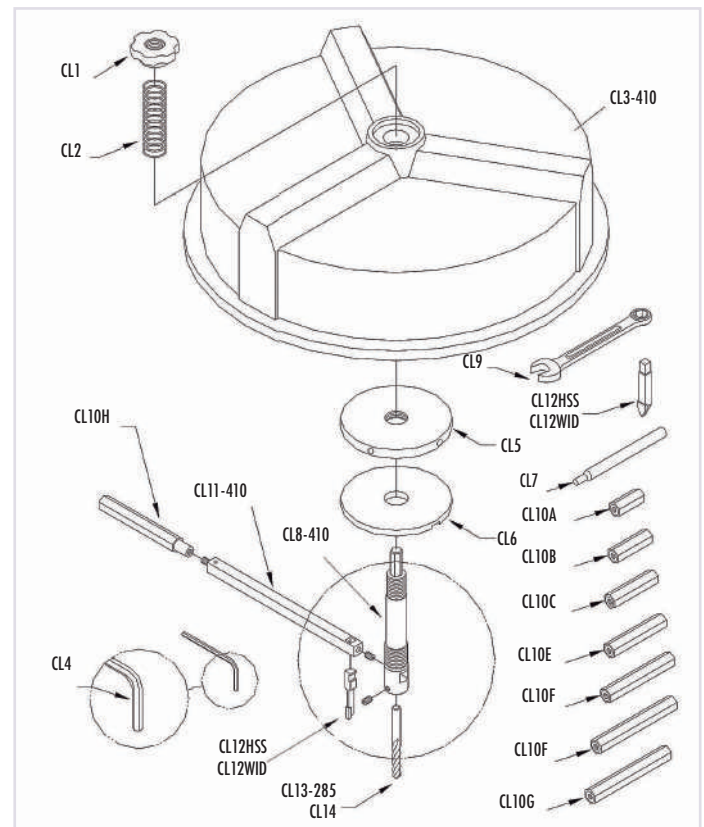

CORONA DE DIAMANTE PARA HORMIGÓN ARMADO CON SISTEMA DE CAMBIO POLY-CLICK

Coronas

Rosa

Ref. CDH

150 mm
CAPACIDAD
DE CORTE



- Trabajar siempre con agua.
- Saque la corona en rotación del orificio practicado. De lo contrario, el efecto palanca generado desprende las pastillas de diamante.
- Extraer el punzón guía una vez la corona ha penetrado en el material.
- Moderar el avance axial al alcanzar la varilla.
- Altas velocidades 2500 - 3000 R.P.M.
- Uso exclusivo en rotación.

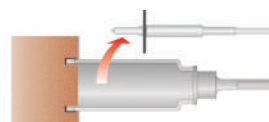

1- Utilizar el punzón guía al iniciar el taladro.

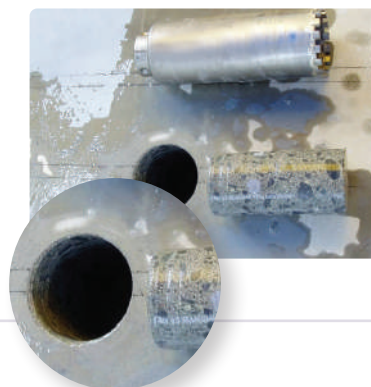

2- Extraemos el punzón cuando la corona haya penetrado levemente.



CDH		
	Ø mm	€
CDH29	29	118,84 *
CDH32	32	118,84 *
CDH35	35	118,84 *
CDH38	38	118,84 *
CDH45	45	118,84 *
CDH50	50	131,75 *
CDH65	65	148,54 *
CDH70	70	161,46 *
CDH75	75	174,38 *
CDH90	90	215,71 *
CDH100	100	264,80 *
CDH120	120	284,17 *
CDH170	170	393,96 *
CDH220	220	527,00 *

El precio no incluye husillo, ni punzón centrador.

*Hasta fin de existencias

BOTE DE REFRIGERACIÓN

Capacidad: 1,1 l.

GBP
9,73 €
ACCESORIOS

	DESCRIPCIÓN	RANGO Ø mm	€
CDHAPH	Mango Hexagonal corto 90mm	25 - 45	129,16 *
CDHAPSDS	SDS PLUS corto 90mm	25 - 45	129,16 *
CDHAPH300	SDS PLUS 300mm	25 - 45	135,63 *
CDHAGH	Mango Hexagonal corto 90mm	50 - 220	148,54 *
CDHAGSDS	SDS PLUS corto 90mm	50 - 220	148,54 *
CDHAGH300	Mango Hexagonal Lt: 300 mm	50 - 220	161,46 *
CDHBP	Punzón centrador	25 - 220	18,08 *

*Hasta fin de existencias